

MagFlux[®]

Electromagnetic Flow Meter

3.05



GB 3.05 MagFlux 071116

We reserve the right to continuously improve our products and make any change in the stated specifications and dimensions without prior notice.

www.mjk.com

DK: +45 45 56 06 56
NO: +47 69 20 60 70
SE: +46 53 31 77 50
NL: +31 251 672171
USA: +1 847 482 8655
AUS: +61 3 9758 8533

General



MagFlux® Electromagnetic Flow Meters deliver very stable and highly accurate flow measurements in conductive liquids.

MagFlux® Flow Meters have no moving parts to foul, create no hydraulic influence on the flow, use a well-proven technology, and communicate using a standard protocol.

MagFlux® Flow Sensors are available in sizes ranging from DN 3 to DN 1200, with standard construction lengths and connections.

MagFlux® Flow Meters can be installed either with the electronics mounted on the flow sensor, on a wall, or mounted in a panel.

Applications

MagFlux® Flow Meters are used for measuring and totalizing flow of conductive liquids in pressurized closed pipe systems.

MagFlux® Flow Meters measure flow in both directions of potable water, wastewater and process fluids.

Function

The MagFlux® operation is based on Faraday's law of induction. When a conductive fluid passes through a magnetic field in the sensor, an electromagnetic voltage is induced between the two electrodes in the flow sensor tube. This voltage (E) is directly proportional to the fluid velocity.

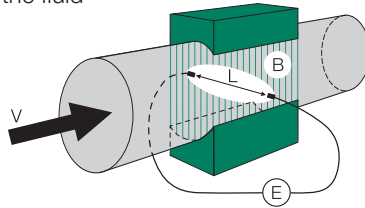

When the internal diameter of the Flow Sensor is known, the actual volume is calculated by the Converter.

The electromagnetic voltage induced between the electrodes equates to:

$$E = L \times B \times V \text{ where:}$$

E: Induced electromagnetic voltage

L: Flow sensor diameter

B: The strength of the magnetic field

V: The velocity of the liquid

The voltage E is measured and consequently converted to a volumetric flow.

Flexible Installation

MJK's modular design is versatile. The Display Unit can be mounted up to 1000 m from the Flow Converter with ordinary twisted wires. It also provides options for mounting the Converter where it is most convenient to make the electrical connections.

One Display Unit can control up to 4 Converters and Flow Sensors for greater economy, space savings and an improved overview of the multiple measurement values.

The MagFlux® Converter and Display Unit mounted directly on the Flow Sensor.

The MagFlux® Converter mounted directly on the flow sensor with a remote mounted Display Unit.

① In noisy environments, twisted shielded cable is recommended.

The MagFlux® Converter and Display Unit remote mounted. For example when the sensor is being buried or submerged.

The MagFlux® Converter is mounted remote from the Flow Sensor, and the Display Unit is mounted separately from the Converter. E.g when the Sensor is being buried.

The MagFlux® Converters are mounted directly on the Flow Sensors, while the remote mounted Display Unit communicates with two MagFlux® Converters and Flow Sensors.

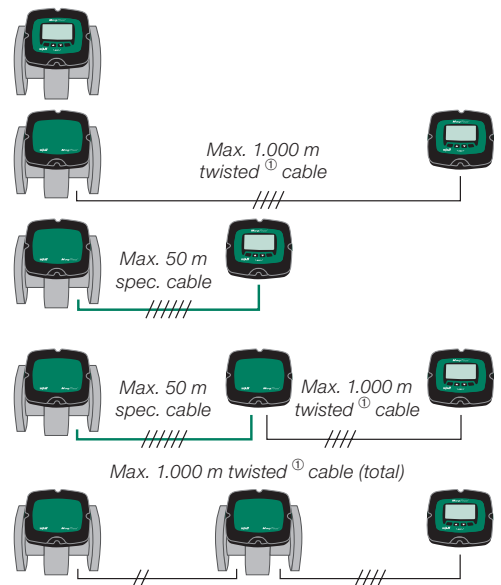

Simple to Operate

The MagFlux[®] Display Unit has many unique and intelligent functions. It has a simple mobile phone-like menu structure and can display text in several selectable languages in metric or English units.

Easy-to-use Menu Structure

The MagFlux[®] PC connection allows downloading configurations and logging data to a PC, and uploading new software updates and instrument customization. All through intuitive steps using a common USB port.

Registering the Flow Sensor

The MagFlux[®] System registers the Flow Sensor to the Converter using a unique coded six-digit serial number technique. It sets calibration data, the nominal diameter and the sensor configuration – making the MagFlux[®] System ready to measure immediately. This avoids complicated and sensitive field calibration and delicate electronics in the sensor, and allows unlimited interchanging of MagFlux[®] Converters and Flow Sensors.

Counters for Flow in Both Directions

The MagFlux[®] Converter has resettable and non-resettable counters for flow in both directions. MagFlux[®] has two batch counters with smart-batch counting.

Forward and Backwards Flow Measurement and Totalizing

The MagFlux[®] System measures flow in both directions and can totalize the net flow for both. A simple menu selection determines the normal flow direction.

Data Logger

The MagFlux[®] built-in 256 kB data logger can log 20,000 entries with time and date. Data is displayed graphically, but can also be exported to a PC via the USB port on the Display Unit.

Flexible In- and Outputs

The MagFlux[®] Converter has one 4-20 mA analogue output, two digital outputs and one digital input. The digital input can stop and zero counter settings or control the batch counters manually. Each alarm can be displayed as a pop-up alarm until they are reset.

Automatic Electrode Cleaning

The MagFlux[®] built-in electronic electrode cleaning system is always active.

User Definable Text

The MagFlux[®] display can be configured by the user for up to five lines of text. The graphic display is automatically adjusted to show the largest characters possible.

Modbus[®] Communication

The Display Unit uses the Modbus[®] communication protocol to connect to the MagFlux[®] Converter or a PLC.

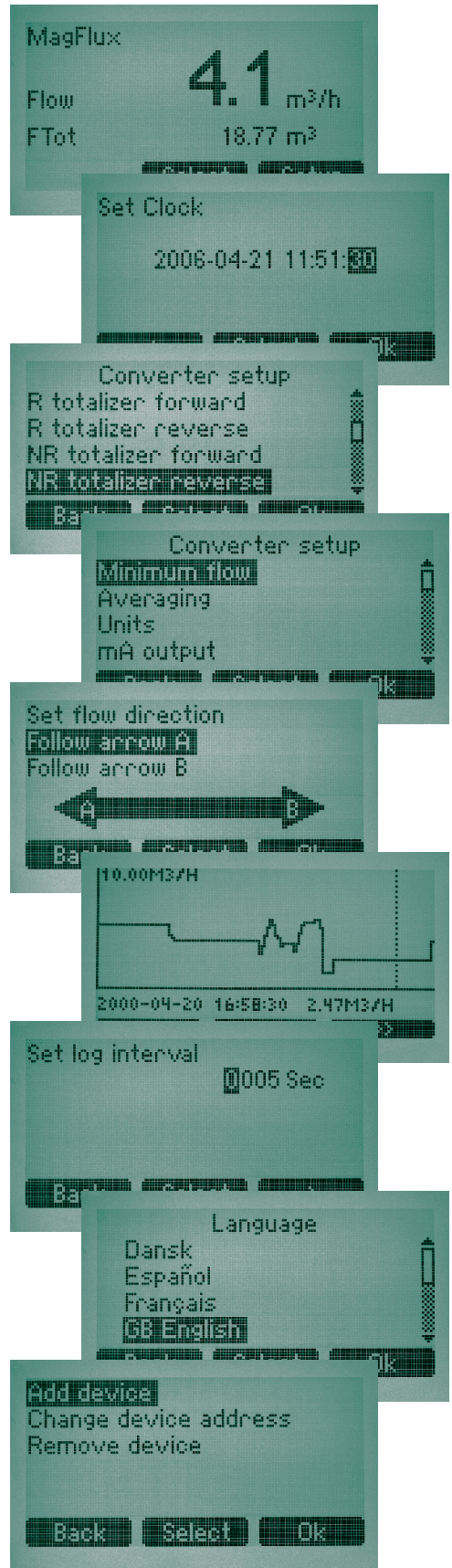

Specifications

Converter and Display Unit

Display unit	
Enclosure rating	Dust- and waterproof IP 67, NEMA 6 (when mounted on Converter)
Housing material	Polycarbonate, glass reinforced
Protection lid	Transparent polycarbonate
Display	White backlit LCD-display (64 x 128 pixels) with softkeys
Indication	Indication of flow, flow direction, volume, totalizers, configuration and graph
Clock	Real-time clock with built-in battery backup
Communication	MODBUS [®] RTU-mode, 9600 baud, 2-wire RS 485, master-mode
Interface	RS 485
Memory	256 Kb Flash Memory, 20.000 entries with date, time and value
Interface	USB 1,1 type mini B, Female
Temperature range	- 20 ... 60 °C

Converter	
Accuracy	+/- 0,1% of reading
Measuring range	Min. range = 0 - 0,2 m/s Max. range = 0 - 10 m/s
Min. liquid conductivity	≥ 5 µS
Analog output	One active 4 - 20 mA, galvanically isolated (max. load 800 Ω)
Digital outputs	One voltage-free electromechanical relay (max. 50 V DC / 1 A) One optically isolated MOSFET relay (max. 50 VAC / V DC / 120 mA) programmable for: totalizer counter, batch counter, high/low flow, system error, empty pipe and flow direction.
Digital inputs	One, max. 30 V DC, < 5 V DC = 0 (low), > 10 V DC = 1 (high), pulse length > 100 ms
Communication:	MODBUS [®] RTU-mode, 9600 baud, 2-wire RS 485, slave-mode
Interface	RS 485 for connection to Display Unit or PLC
Power supply	24 V AC, 50 / 60 Hz ± 10 % or 115 V AC, 50 / 60 Hz ± 10 % or 230 V AC, 50 / 60 Hz ± 10 % Power consumption max. 10 W
Cabinet material	Polycarbonate, glass reinforced
Enclosure rating	IP 67, NEMA 6. The MagFlux [®] flowmeter can be submersible (IP68/NEMA 6P) by using gel potting kit (Part no. 579035) and choosing a wall-mounted converter.
Temperature range	- 20 ... 60 °C
Weight	1,0 kg
CE approvals	EN 61000-6-4:2001, EN 61000-6-2:2001

Connection box	
Enclosure rating	IP 68, NEMA 6X (using gel potting kit part no. 579035). The flowmeter can withstand unlimited immersion of up to 10 m of water.
Cabinet material	Polycarbonate, glass reinforced
Temperature range	- 20 ... 100 °C

Mechanical Dimensions,

Converter and Display Unit

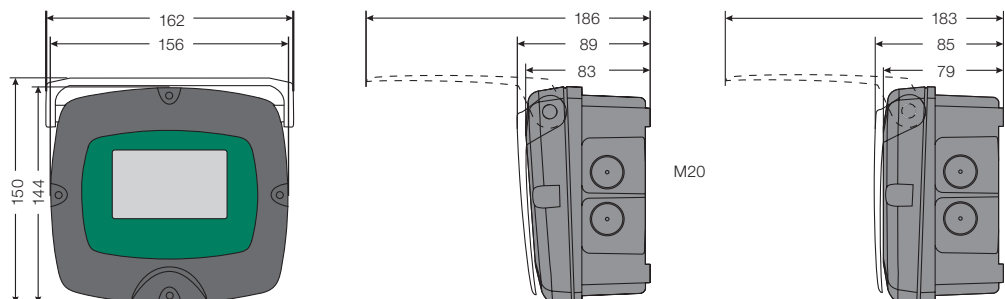

IP 68 Protection



If the *MagFlux®* Sensor is to be buried or submerged under water, the Converter and Display Unit must be remote mounted, and the electrical connection to the sensor must be potted using gel potting kit part no. 579035.

Order Numbers

MagFlux® Converters, Displays and Accessories

MagFlux® converter	
207910	MagFlux® Converter (blind) for sensor mounting 230 V AC Optional 115 V AC
207911	MagFlux® Converter (blind) for sensor mounting 24 V AC
207912	MagFlux® Converter (blind) 10 - 30 V DC
207920	MagFlux® Converter with Display Unit for Flow Sensor mounting 230 V AC Optional 115 V AC
207921	MagFlux® Converter with Display Unit for Flow Sensor mounting 24 V AC
207922	MagFlux® Converter with Display Unit 10 - 30 V DC
207925	MagFlux® Converter with Display Unit for wall mounting 230 V AC Optional 115 V AC
207926	MagFlux® Converter with Display Unit for wall mounting 24 V AC

Accessories	
207930	MagFlux® Wall Mounting Kit
207935	MagFlux® Panel Mounting Bracket
207937	MagFlux® Lightning Protection Kit
207940	MagFlux® Display Unit
579035	MagFlux® Gel Potting Kit
691080	MagFlux® Sensor Cable
691095	MagFlux® USB Cable
840110	MJK-Field Link software for communication between <i>MagFlux®</i> and PC

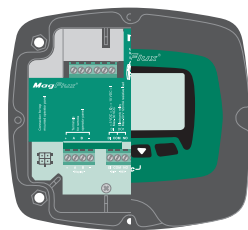

207920, MagFlux® Converter with Display Unit for Sensor Mounting

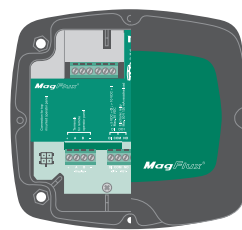

207930, MagFlux® Wall Mounting Kit

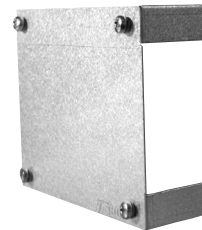

207935, MagFlux® Panel Mounting Bracket



MagFlux® mounted in a panel

Electrical Connections on the Converter

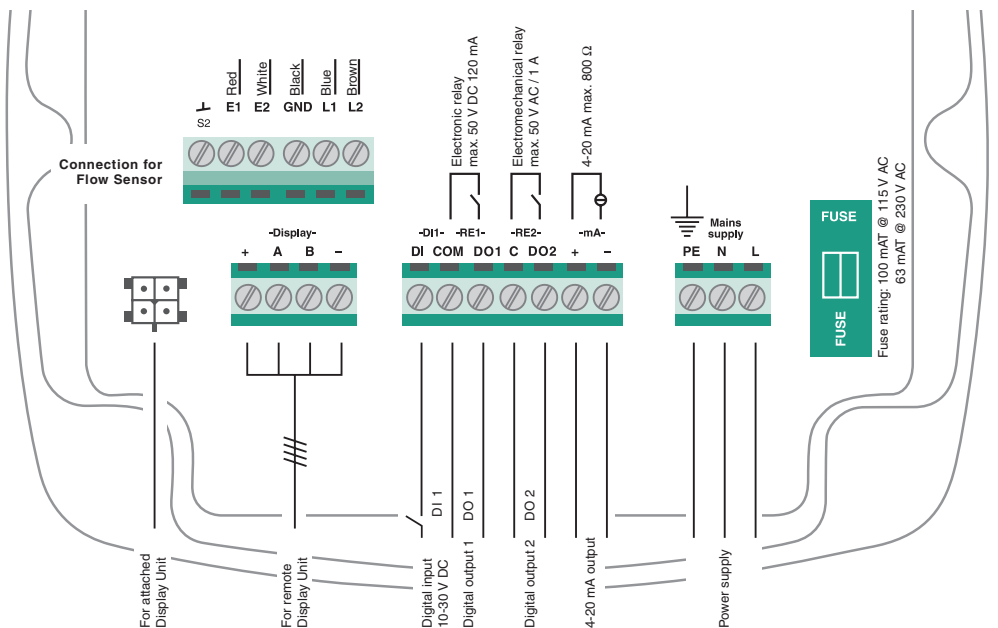

Example 1

Compact Converter and Display Unit on Flow Sensor

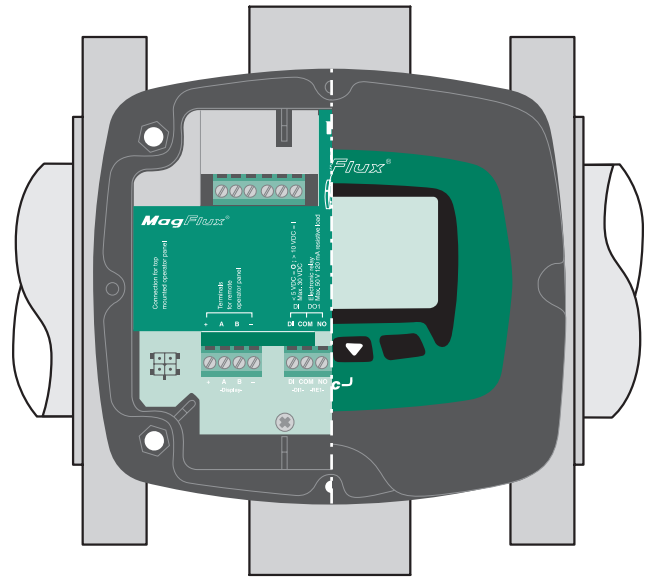

Order numbers

207xxx MagFlux® Flow Sensor

207920 MagFlux® Converter with Display Unit, 230/115 V AC

Example 2

Remote Converter, Connection Box on Flow Sensor

If the MagFlux® Sensor is to be buried or submerged under water, the Converter and Display Unit must be remote mounted, and the electrical connection to the Flow Sensor must be potted using Gel Potting Kit part no. 579035.

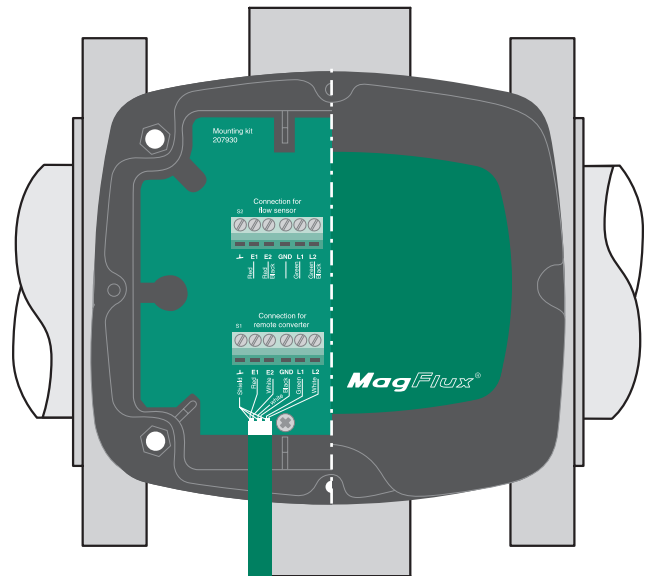

Converter and Display Unit in Wall/Panel Housing

Order numbers

207xxx MagFlux® Flow Sensor

207925 MagFlux® Converter with Display Unit for wall mounting, 230/115 V AC

691080 MagFlux® Sensor Cable

577935 MagFlux® Gel Potting Kit IP68.

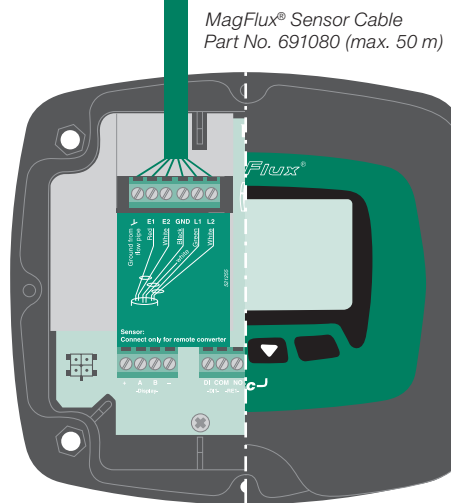

Example 3

Remote Display and Multiple Converter Wiring

The communication between the Display Unit is carried out on a 2-wire cable using ModBus® communication on the RS-485 transmission lines.

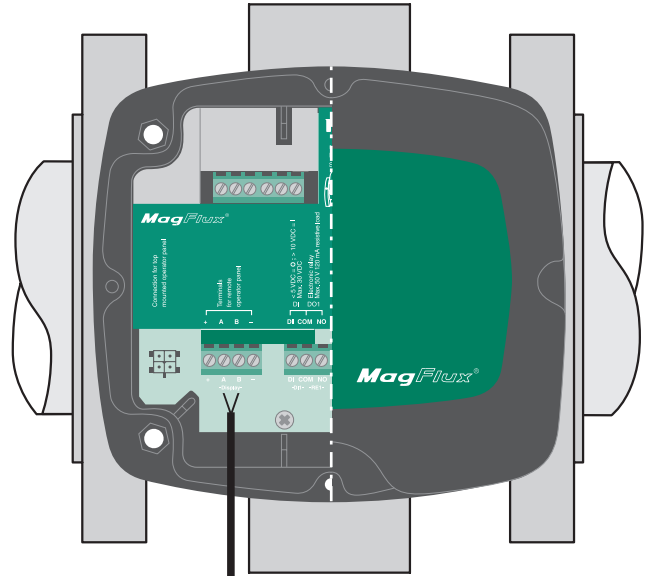

2-wire cable (max.1000 m). Twisted shielded cable is recommended

Two additional wires supply power from one of the Converters to the Display Unit.

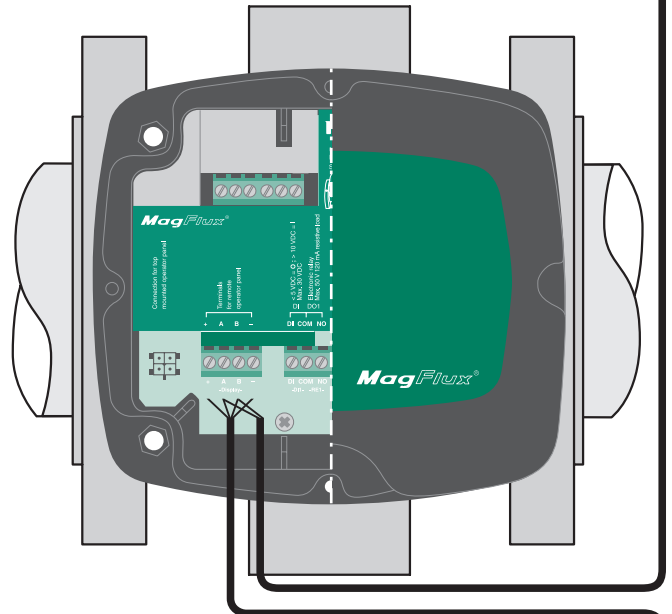

4-wire cable (max. 1000 m). Twisted shielded cable is recommended

The Display Unit on wall mounting kit. The Display Unit can operate up to four Converters.

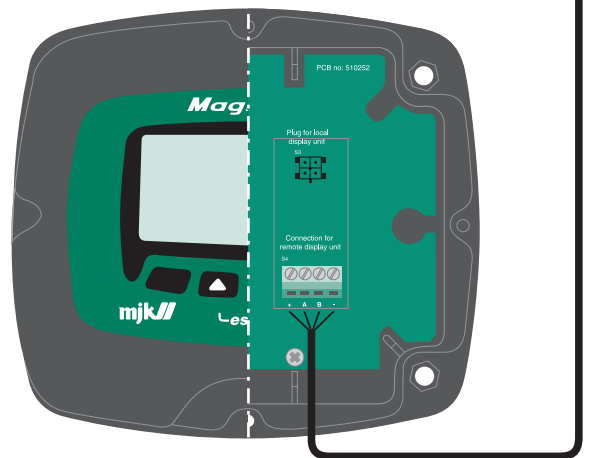

Order numbers

2 pcs. 207xxx MagFlux®
Flow Sensors

1 pc. 207910 MagFlux®
Converter (blind) for sensor
mounting, 230/115 V AC

1 pc. 207925 MagFlux®
Converter with Display Unit for
wall mounting, 230/115 V AC

Flow Sensor 7100

Housing: Carbon steel

Lining: PTFE

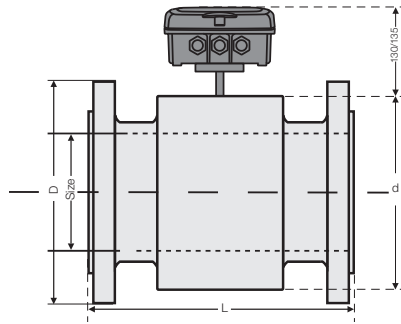

Sizes and Ordering information

Sizes and Ordering Information - EN Flanges					
Size	Pressure	D	L	Weight	Order no.
DN	PN ^②	[mm]	[mm]	[kg]	
15	40	95	200	3,5	207107
20	40	105	200	3,5	207110
25	40	115	200	3,5	207113
32	40	140	200	6	207116
40	40	150	200	7	207119
50	16	165	200	8	207122
65	16	185	200	10	207125
80	16	200	200	12	207128
100	16	220	250	16	207131
125	16	250	250	21	207134
150	16	285	300	28	207137
200	16	340	350	35	207140
250	10	395	450	43	207143
300	10	445	500	55	207146
350	10	505	550	66	207149
400	10	565	600	94	207152

^② PN 25-40-64. Consult the factory.

Sizes and Ordering Information - ANSI Flanges					
Size	Pressure	D	L	Weight	Order no.
[inch]	[psi] ^②	[mm]	[mm]	[kg]	
½"	150	90	200	3,5	297107
¾"	150	100	200	3,5	297110
1"	150	110	200	3,5	297113
1¼"	150	120	200	6	297116
1½"	150	130	200	7	297119
2"	150	150	200	8	297122
2½"	150	180	200	10	297125
3"	150	190	200	12	297128
4"	150	230	250	16	297131
5"	150	255	250	21	297134
6"	150	280	300	28	297137
8"	150	345	350	35	297140
10"	150	405	450	43	297143
12"	150	485	500	55	297146
14"	150	535	550	66	297149
16"	150	600	600	94	297152

^② 300-600 psi. Consult the factory.

Specifications

Specifications - EN / ANSI Flanges	
Mounting	Flange EN-1092-1 / ANSI B 16.5
<i>Materials</i>	
Housing ^⑥	Carbon steel
Flanges ^⑥	Carbon steel
Lining	PTFE
Electrodes ^{③ ⑤}	1,4571 / AISI 316 TI
Accuracy ^④	Better than ± 0,25 %
Media temp. range	-20...150 °C / 0...300 °F
<i>Ambient temp. range</i>	
Compact converter	-10...60 °C / 15...140 °F
Remote converter	-20...100 °C / 0...200 °F
Enclosure	IP67, IP 68 / NEMA 4, NEMA 6P
^③ Hastelloy C4, platinum, and titanium. Consult the factory.	
^④ Of measured value.	
^⑤ From DN 50 / 2" and up, a ground electrode is built in.	
^⑥ Also available in Steel 304/316 SS. Consult the factory.	

Flow Sensor 7200

Housing: Carbon steel
Lining: Hard rubber

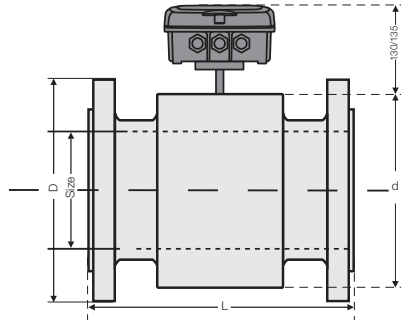

Sizes and Ordering information

Sizes and Ordering Information - EN Flanges

Size	Pressure	D	L	Weight	Order no.
DN	PN ②	[mm]	[mm]	[kg]	
15	40	95	200	3,5	207207
20	40	105	200	3,5	207210
25	40	115	200	3,5	207213
32	40	140	200	6	207216
40	40	150	200	7	207219
50	16	165	200	8	207222
65	16	185	200	10	207225
80	16	200	200	12	207228
100	16	220	250	16	207231
125	16	250	250	21	207234
150	16	285	300	28	207237
200	16	340	350	35	207240
250	10	395	450	43	207243
300	10	445	500	55	207246
350	10	505	550	66	207249
400	10	565	600	94	207252
450	10	615	600	105	207255
500	10	670	600	122	207258
600	10	780	600	158	207261
700	10	895	700	230	207264
800	6	1015	800	325	207267
900	6	1115	900	420	207270
1000	6	1230	1000	510	207273
1200	6	1450	1200	680	207276

② PN 25-40-64. Consult the factory.

Sizes and Ordering Information - ANSI Flanges

Size	Pressure	D	L	Weight	Order no.
[inch]	[psi]②	[mm]	[mm]	[kg]	
½"	150	90	200	3,5	297207
¾"	150	100	200	3,5	297210
1"	150	110	200	3,5	297213
1¼"	150	120	200	6	297216
1½"	150	130	200	7	297219
2"	150	150	200	8	297222
2½"	150	180	200	10	297225
3"	150	190	200	12	297228
4"	150	230	250	16	297231
5"	150	255	250	21	297234
6"	150	280	300	28	297237
8"	150	345	350	35	297240
10"	150	405	450	43	297243
12"	150	485	500	55	297246
14"	150	535	550	66	297249
16"	150	600	600	94	297252
18"	150	635	600	105	297255
20"	150	700	600	122	297258
24"	150	815	600	158	297261
28"	150	930	600	230	297264
32"	150	1050	800	325	297267
36"	150	1170	800	420	297270
40"	150	1275	800	510	297273
48"	150	1510	1000	680	297276

② 300-600 psi. Consult the factory.

Specifications

Specifications - EN / ANSI Flanges

Mounting	Flange EN-1092-1 / ANSI B 16.5
Materials	
Housing ③	Carbon steel
Flanges ⑥	Carbon steel
Lining	Hard rubber
Electrodes ③ ⑤	1,4571 / AISI 316 TI
Accuracy ④	Better than ± 0,25 %
Media temp. range	-10...80 °C / 15...175 °F
Ambient temp. range	
Compact converter	-10...60 °C / 15...140 °F
Remote converter	-10...80 °C / 15...175 °F
Enclosure	IP67, IP68 / NEMA 4, NEMA 6P
③ Hastelloy C4, platinum, and titanium. Consult the factory.	
④ Of measured value.	
⑤ From DN 50 / 2" and up, a ground electrode is built in.	
⑥ Also available in Steel 304/316 SS. Consult the factory.	

Flow Sensor 7300

Housing: Carbon steel

Lining: PTFE

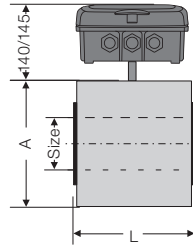

Sizes and Ordering information

Sizes and Ordering Information						
DN	Size	Pressure PN	A [mm]	L [mm]	Weight [kg]	Order no.
3	1/8"	10	105	100	2	207301 ⑦
6	1/4"	10	105	100	2	207302 ⑦
8	5/16"	10	105	100	2	207303 ⑦
10	3/8"	10	105	100	2	207304 ⑦
15	1/2"	40	62	74	1,1	207307
20	3/4"	40	62	74	1,1	207310
25	1"	40	72	104	1,5	207313
32	1 1/4"	40	82	104	1,8	207316
40	1 1/2"	40	92	104	2,2	207319
50	2"	16	107	104	2,8	207322
65	2 1/2"	16	127	104	3,2	207325
80	3"	16	142	104	3,5	207328
100	4"	16	162	104	4	207331
125	5"	16	192	134	6	207334
150	6"	16	218	134	8	207337
200	8"	16	274	219	10	207340

Specifications

Specifications	
Mounting	Wafer
<i>Materials</i>	
Housing ⑥	Carbon steel
Lining	PTFE
Electrodes ③ ⑤	1,4571 / AISI 316 TI
Accuracy ④	Better than $\pm 0,25\%$
Media temp. range	-20...150 °C / 0...300 °F
<i>Ambient temp. range</i>	
Compact converter	-10...60 °C / 15...140 °F
Remote converter	-20...100 °C / 0...200 °F
Enclosure	IP67 / NEMA 4
③ Hastelloy C4, platinum, and titanium. Consult the factory.	
④ Of measured value.	
⑤ From DN 50 / 2" and up, built in ground electrode.	
⑥ Also available in Steel 304/316 SS. Consult the factory.	
⑦ Standard for DN 3 - 10 / 1/8" - 3/8" is AISI 316 TI.	

Flow Sensor 7400

Housing: Carbon steel

Lining: Hard rubber

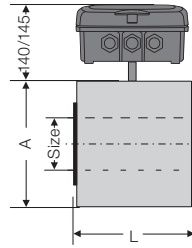

Sizes and Ordering information

Sizes and Ordering Information						
Size	Pressure	A	L	Weight	Order no.	
DN [inch]	PN	[mm]	[mm]	[kg]		
15	1/2"	40	62	74	1,1	207407
20	3/4"	40	62	74	1,1	207410
25	1"	40	72	104	1,5	207413
32	1 1/4"	40	82	104	1,8	207416
40	1 1/2"	40	92	104	2,2	207419
50	2"	16	107	104	2,8	207422
65	2 1/2"	16	127	104	3,2	207425
80	3"	16	142	104	3,5	207428
100	4"	16	162	104	4	207431
125	5"	16	192	134	6	207434
150	6"	16	218	134	8	207437
200	8"	16	274	219	10	207440

Specifications

Specifications	
Mounting	Wafer
Materials	
Housing ⑥	Carbon steel
Lining	Hard rubber
Electrodes ③ ⑤	1,4571 / AISI 316 TI
Accuracy ④	Better than ± 0,25 %
Media temp. range	-10...80 °C / 15...175 °F
Ambient temp. range	
Compact converter	-10...60 °C / 15...140 °F
Remote converter	-10...80 °C / 15...175 °F
Enclosure	IP67
③ Hastelloy C4, platinum, and titanium. Consult the factory.	
④ Of measured value.	
⑤ From DN 50 / 2" and up, built in ground electrode.	
⑥ Also available in Steel 304/316 SS. Consult the factory.	

Flow Sensor 7600

Housing: Carbon steel
Lining: Soft rubber

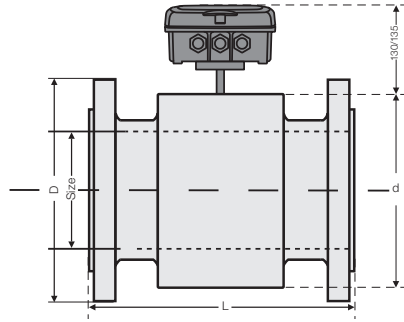

Sizes and Ordering information

Sizes and Ordering Information - EN Flanges					
Size	Pressure	D	L	Weight	Order no.
DN	PN ②	[mm]	[mm]	[kg]	
15	40	95	200	3,5	207607
20	40	105	200	3,5	207610
25	40	115	200	3,5	207613
32	40	140	200	6	207616
40	40	150	200	7	207619
50	16	165	200	8	207622
65	16	185	200	10	207625
80	16	200	200	12	207628
100	16	220	250	16	207631
125	16	250	250	21	207634
150	16	285	300	28	207637
200	16	340	350	35	207640
250	10	395	450	43	207643
300	10	445	500	55	207646
350	10	505	550	66	207649
400	10	565	600	94	207652
450	10	615	600	105	207655
500	10	670	600	122	207658
600	10	780	600	158	207661
700	10	895	700	230	207664
800	6	1015	800	325	207667
900	6	1115	900	420	207670
1000	6	1230	1000	510	207673
1200	6	1450	1200	680	207676

② PN 25-40-64. Consult the factory.

Sizes and Ordering Information - ANSI Flanges					
Size	Pressure	D	L	Weight	Order no.
[inch]	[psi]	[mm]	[mm]	[kg]	
½"	150	90	200	3,5	297607
¾"	150	100	200	3,5	297610
1"	150	110	200	3,5	297613
1¼"	150	120	200	6	297616
1½"	150	130	200	7	297619
2"	150	150	200	8	297622
2½"	150	180	200	10	297625
3"	150	190	200	12	297628
4"	150	230	250	16	297631
5"	150	255	250	21	297934
6"	150	280	300	28	297937
8"	150	345	350	35	297940
10"	150	405	450	43	297643
12"	150	485	500	55	297646
14"	150	535	550	66	297649
16"	150	600	600	94	297652
18"	150	635	600	105	297655
20"	150	700	600	122	297658
24"	150	815	600	158	297661
28"	150	930	600	230	297664
32"	150	1050	800	325	297667
36"	150	1170	800	420	297670
40"	150	1275	800	510	297673
48"	150	1510	1000	680	297676

③ 300-600 psi. Consult the factory.

Specifications

Specifications - EN / ANSI Flanges	
Mounting	Flange EN-1092-1 / ANSI B 16.5
Materials	
Housing ⑥	Carbon steel
Flanges ⑥	Carbon steel
Lining	Soft rubber
Electrodes ③ ⑤	1,4571 / AISI 316 TI
Accuracy ④	Better than ± 0,25 %
Media temp. range	-10...80 °C / 15...175 °F
Ambient temp. range	
Compact converter	-10...60 °C / 15...140 °F
Remote converter:	-10...80 °C / 15...175 °F
Enclosure	IP67, IP68 / NEMA 4, NEMA 6P

③ Hastelloy C4, platinum, and titanium. Consult the factory.
 ④ Of measured value.
 ⑤ From DN 50 / 2" and up, a ground electrode is built in.
 ⑥ Also available in Steel 304/316 SS. Consult the factory.

Grounding Rings

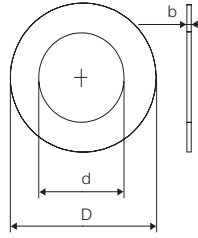

Sizes and Ordering information

Sizes and Ordering Information						
DN	Size [inch]	D	d	b	Weight [kg]	Order no.
		[mm]				
15	1/2"	50	22	6	0,06	207807
20	3/4"	60	28	6	0,08	207810
25	1"	71	35	6	0,1	207813
32	1 1/4"	82	43	6	0,13	207816
40	1 1/2"	92	49	6	0,16	207819
50	2"	107	61	6	0,2	207822
65	2 1/2"	127	77	6	0,26	207825
80	3"	142	90	6	0,32	207828
100	4"	162	115	6	0,4	207831
125	5"	192	141	6	0,5	207834
150	6"	218	170	6	0,6	207837
200	8"	273	220	6	0,8	207840
250	10"	328	274	6	1,0	207843
300	12"	378	325	6	1,2	207846
350	14"	438	360	6	1,4	207849
400	16"	489	411	6	1,6	207852
450	18"	539	463	6	1,8	207855
500	20"	594	514	6	2,0	207858

Specifications

Specifications	
Material	AISI 316 SS
Wire	2,5 mm ² / AWG 13

Flow Sensor Sizing

Min. / Max. Flow and Default mA Settings				
Size		Qmin = 0,2 m/s	Qmax = 10 m/s	20 mA
DN	[inch]		[l/h]	
3	1/8"	5,09	254	250
6	1/4"	20,4	1018	1000
8	5/16"	36,2	1810	2000
10	3/8"	56,5	2827	5000
15	1/2"	127	6362	5000
20	3/4"	226	11304	10000
25	1"	353	17676	20000
32	1 1/4"	579	28944	30000
40	1 1/2"	905	45360	50000
50	2"	1414	70560	75000
-	-		[m3/h]	
65	2 1/2"	2,39	119	100
80	3"	3,62	181	200
100	4"	5,65	283	300
125	5"	8,84	442	400
150	6"	12,7	636	600
200	8"	22,6	1131	1000
250	10"	35,3	1767	2000
300	12"	50,9	2545	2500
350	14"	69,3	3464	3000
400	16"	90,5	4524	4500
450	18"	115	5726	6000
500	20"	141	7069	7000
600	24"	204	10179	10000
700	28"	277	13854	15000
800	32"	362	18095	20000
900	36"	458	22902	25000
1000	40"	565	28274	30000
1200	48"	814	40715	40000

Flow Sensor Sizing - Example

To calculate the correct size of the Flow Sensor the recommended flow velocity should be between 1 and 3 m/s to achieve high accuracy at low velocities (down to 0,2 m/s), to ensure safe operation of the tube system and to minimize pressure losses.

The flow curves and graphs on the following page illustrate how the size of the Flow Sensor is calculated to get the required measuring accuracy.

Example

A volume of 50 m³/h is running through a pipe that measures 100 mm in internal diameter. To select the correct MagFlux® Flow Sensor, the liquid velocity should be in the range 1 - 3 m/s for 50 m³/hr.

If a MagFlux® Flow Sensor with the same internal diameter as the pipe is selected (100 mm), the flow velocity will be 1.5 m/s at a flow rate of 42 m³/h. The diagram and table below also shows that a flow between 5.65 m³/h and 283 m³/h can be measured.

Flow / Velocity Graph
(metric)

Nominal diameter of MagFlux® flow sensor

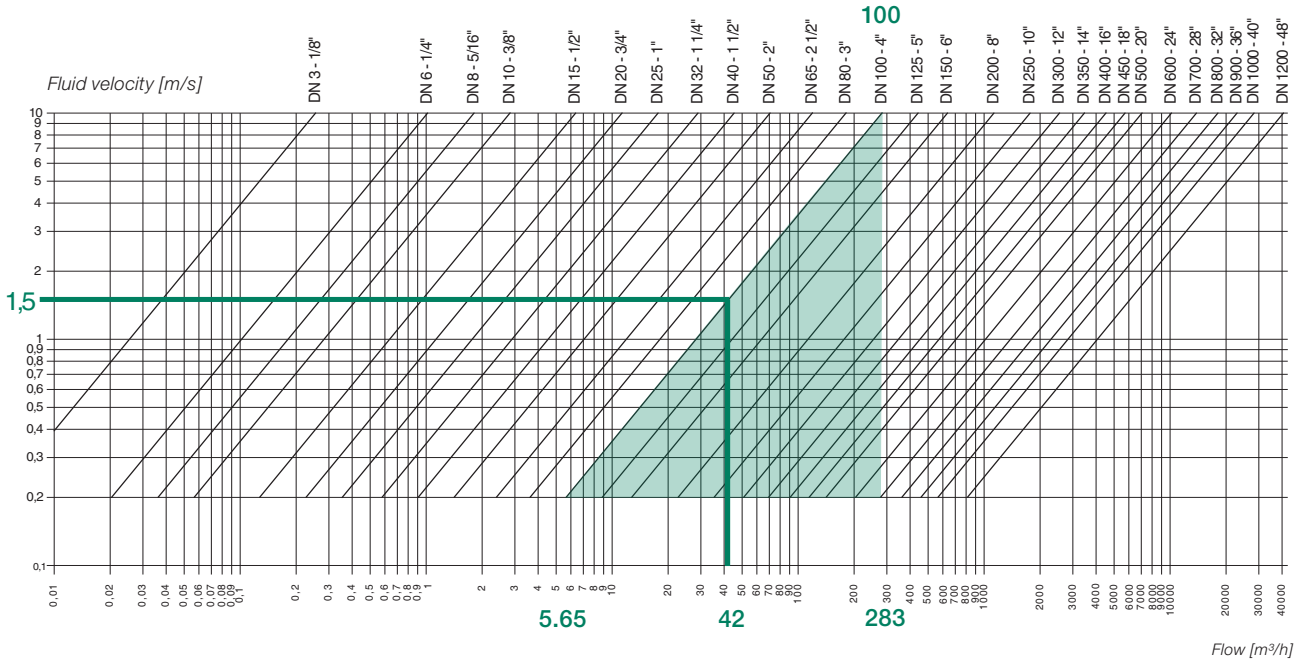

Measurement Accuracy

Example:
If a 100 mm MagFlux® Flow Sensor is selected, the diagram shows the available measuring accuracy between 0.2 - 10 m/s (here: 0.25%).

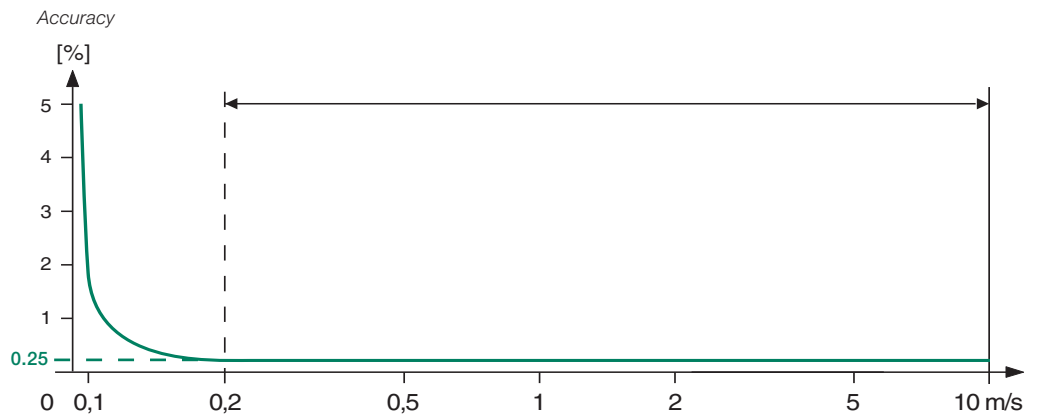

Reducing the Flow Meter Size

When the size of the Flow Meter is reduced to cause the flow to reach a sufficient velocity, the pipe size has to be reduced. This will cause a pressure loss which can be calculated using the pressure loss chart at the right.

When the MagFlux[®] Sensor is smaller than nominal pipe diameter, the pressure loss can be checked, using the pressure loss chart.

Example:

A MagFlux[®] Flow Sensor with an internal diameter of 80 mm is selected and the pipe size is 100 mm. Consequently the fluid velocity for a flow of approximately 50m³/h will increase to about 3 m/s (see graph on page 11).

Using a DN80 mm MagFlux[®] flow sensor also leads to a smaller measurement range (3.62 m³/h - 181 m³/h). See graph on page 11.

The diagram on the right shows that reducing the pipe size from 100 to 80 mm will cause a pressure loss of 3 mbar (0.003 bar).

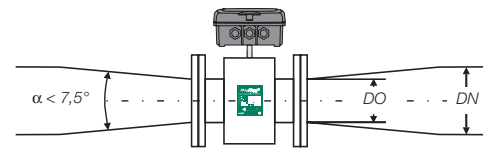
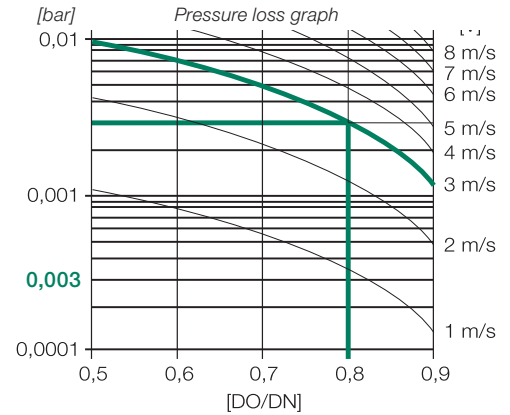

Sensor Mounting Conditions

Accurate flow measurement requires a minimum of three (3) pipe diameters of straight pipe upstream and two (2) pipe diameters of

straight pipe downstream from the center of the Flow Sensor.

Minimum pipe diameter distances for accurate MagFlux[®] flow measurements:

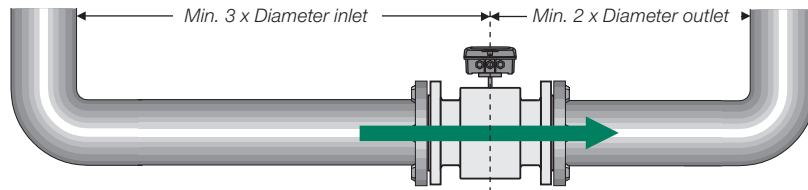

Distributed by:

MJK offices

Denmark
www.mjk.dk
mjk@mjk.dk
+45 45 56 06 56

Norway
www.mjk.no
mjk@mjk.no
+47 69 20 60 70

The Netherlands
www.mjk.com
mjknl@mjk.com
+31 251 672171

Sweden
www.mjk.se
kontoret@mjk.se
+46 53 31 77 50

North America
www.mjk.com
mjkusa@mjk.com
+1 847 482 8655

Australia
www.mjk.com
mjk@mjk.com
+61 3 9755 1529