

# MagFlux®

## Electromagnetic Flow Meter



## Installation and User Manual

## Declaration of Conformity

### Konformitetserklæring

Vi, MJK Automation A/S,  
DK-2850 Nærum, påtager os  
det fulde ansvar for at produktet

### Declaration of Conformity

We, MJK Automation A/S,  
DK-2850 Nærum, declare under  
our sole responsibility that the  
product

### Konformitätserklärung

Wir, MJK Automation A/S,  
DK-2850 Nærum, erklären in  
alleiniger Verantwortung, dass  
das Produkt

# MagFlux® Electromagnetic Flowmeter

som denne erklæring angår,  
er i overensstemmelse med  
følgende standard(er) eller andre  
normdokument(er).

EN61000-6-3/-4:2001,  
EN61000-6-1/-2:1999

efter bestemmelserne i  
direktiv

89/336/EEC; 92/31/EEC

### Declaration de conformité

Nous, MJK Automation A/S,  
DK-2850 Nærum, déclarons  
sous notre seule responsabilité  
que le produit

to which this declaration relates  
is in conformity with the following  
standard(s) or other normative  
document(s).

EN61000-6-3/-4:2001,  
EN61000-6-1/-2:1999

following the provisions of  
Directive

89/336/EEC; 92/31/EEC

### Dichiarazione di conformità

Noi, MJK Automation A/S,  
DK-2850 Nærum, dichiariamo  
sotto la nostra esclusiva respon-  
sabilità che l'apparecchio

auf das sich diese Erklärung  
bezieht mit der/den folgenden  
Nor me(en) oder normativen  
Dokument(en) übereinstimmt.

EN61000-6-3/-4:2001,  
EN61000-6-1/-2:1999

Gemäss den Bestimmungen der  
Richtlinie

89/336/EEC; 92/31/EEC

### Declaración de Conformidad

Nosotros, MJK Automation A/S,  
DK-2850 Nærum, declaramos  
bajo nuestra única responsabili-  
dad que el producto

# MagFlux® Electromagnetic Flowmeter

auquel se réfère cette déclara-  
tion est conforme à la (aux)  
norme(s) ou autre(s) document(s)  
normatif(s)

EN61000-6-3/-4:2001,  
EN61000-6-1/-2:1999

conformément aux dispositions  
de Directive

89/336/EEC; 92/31/EEC

al quale questa dichiarazione si  
riferisce, è conforme alla seg-  
uente normativa(e) standard o ad  
altri documenti di normativa(e)

EN61000-6-3/-4:2001,  
EN61000-6-1/-2:1999

conformemente alla disposizioni  
della Direzione

89/336/EEC; 92/31/EEC

al cual se refiere esta de-  
claración, está en conformidad  
con la(s) siguiente(e) norma(s) u  
otros documentos normativos

EN61000-6-3/-4:2001,  
EN61000-6-1/-2:1999

según las disposiciones de la(s)  
directiva(s)

89/336/EEC; 92/31/EEC

21.11.2006

  
Jens Kruse

# Table of Contents

<b>1. Introduction</b>	<b>7</b>
About this Manual . . . . .	8
Operating Principles . . . . .	10
The <i>MagFlux®</i> Flow Meter . . . . .	11
<b>2. Safety, Repair and Product Identification</b>	<b>13</b>
Safety instructions . . . . .	13
Physical Mounting . . . . .	13
Repair . . . . .	13
Product Identification . . . . .	14
<b>3. Flow Sensor</b>	<b>15</b>
Minimum conductivity . . . . .	15
Liner selection . . . . .	15
Electrode selection . . . . .	15
Mounting location . . . . .	15
Pressure loss . . . . .	16
Accuracy . . . . .	17
Sizing . . . . .	17
Sizing Chart . . . . .	18
Pipe System . . . . .	19
Cabinet Mounted on the Flow Sensor . . . . .	22
Potential Equalization and Grounding . . . . .	23
Type 7100/7200/7600 in Conductive Pipes . . . . .	23
Type 7100/7200/7600 in Non-conductive Pipes . . . . .	23
Type 7300/7400 in Conductive Pipes . . . . .	24
Type 7300/7400 in Non-conductive Pipes . . . . .	24
<b>4. Flow Converter</b>	<b>25</b>
Electrical Mounting . . . . .	25
Power Supply . . . . .	26
Changing the Power Supply Voltage 230/115 V AC . . . . .	27
Analogue Output . . . . .	29
Digital Input . . . . .	30
Local (compact) Flow Sensor . . . . .	30
Remote Flow Sensor . . . . .	31
Converter Connection Board - Local . . . . .	31
Converter Connection Board - Remote . . . . .	32
<b>5. System Configuration Examples</b>	<b>33</b>
Compact Converter and Display Unit on Flow Sensor . . . . .	33
Remote Converter with Connection Box on Flow Sensor . . . . .	34
Wiring Schematic #1 . . . . .	35

Remote Display and Multiple Converters Wiring . . . . .	36
Wiring Schematic #2 . . . . .	37
<b>6. Startup</b>	<b>39</b>
Initial Checks . . . . .	39
Initial Flow Measurement . . . . .	39
Flow Direction Check . . . . .	39
Language Selection . . . . .	39
Display Read-out, one connected unit . . . . .	40
Display Read-out, several connected units . . . . .	41
Display Keys . . . . .	41
Initial Setup . . . . .	43
<b>7. MagFlux Menus</b>	<b>47</b>
<b>Main Menu</b> . . . . .	<b>47</b>
<b>Specify Main Screen</b> . . . . .	<b>48</b>
<b>Factory Settings</b> . . . . .	<b>51</b>
Data Logger . . . . .	55
Graph Display . . . . .	57
<b>Password</b> . . . . .	<b>58</b>
Set Sensor Name . . . . .	59
<b>Converter Setup</b> . . . . .	<b>61</b>
Minimum Flow . . . . .	62
Averaging . . . . .	62
Units . . . . .	63
mA Output . . . . .	63
Flow Forward . . . . .	64
Flow Reverse . . . . .	65
Forward & Rev. (12mA=0) . . . . .	65
Forward & rev. (4mA=0) . . . . .	66
Not in use . . . . .	66
Totalizers . . . . .	67
Settings and Limits for Resettable Totalizers . . . . .	67
Resettable Totalizers . . . . .	70
Resettable Forward Totalizer . . . . .	71
Resettable Reverse Totalizer . . . . .	71
Resettable Sum Totalizer . . . . .	71
Non-Resettable Totalizers . . . . .	72
NR Forward Totalizer . . . . .	72
NR Reverse Totalizer . . . . .	72
NR Sum Totalizer . . . . .	72
Batch Counters 1 & 2 . . . . .	73
Settings and Limits for Batch Counters . . . . .	78
High Flow/Low Flow . . . . .	81
Flow Direction . . . . .	83
Empty Pipe . . . . .	84

24h Flow .....	85
Status .....	85
Service Menu .....	86
<b>Display Setup .....</b>	<b>95</b>
Language .....	96
Set Clock .....	97
Modbus .....	98
Factory Settings .....	100
Display SW Version .....	100
<b>8. Mechanical Dimensions .....</b>	<b>101</b>
Standard Flanges - EN-1092-1:2001 - Europe .....	101
Standard Flanges - ANSI B 16.5 - U.S.A. ....	102
Standard Flanges - AS-4087-2004 - Australia .....	103
Standard Flanges - AS-4087-2004 (cont'd) .....	104
Standard Flanges - AS-4087-2004 (cont'd) .....	105
<b>Appendix A. Pop-up and Error Messages .....</b>	<b>107</b>
<b>Appendix B. MJK-Field Link Software .....</b>	<b>111</b>
<b>Appendix C. FAQs - Frequently Asked Questions .....</b>	<b>115</b>
<b>Appendix D. Front Panel Cut-out Drawing .....</b>	<b>118</b>
<b>Appendix E. Test Certificate .....</b>	<b>119</b>
<b>Appendix F. Log Files .....</b>	<b>120</b>
<b>Appendix G. Digital Input/Output Connections .....</b>	<b>123</b>
<b>Appendix H. Remote Slave Display Unit .....</b>	<b>124</b>
Connection Board - with a remote "slave" display unit .....	124
Converter Connection Board - with a "master" display unit .....	125
Wiring .....	125
Configuration for the master unit .....	125
Configuration for the slave unit .....	125
<b>Main Menu Overview .....</b>	<b>126</b>
<b>Converter Setup Menu Overview .....</b>	<b>128</b>
<b>Service Menu Overview .....</b>	<b>138</b>
<b>Display Setup Menu Overview .....</b>	<b>142</b>



## 1. Introduction

Thank you for choosing the MJK **MagFlux®** electromagnetic flow meter. We have done our utmost to design and manufacture a flow meter that satisfies your requirements.

The **MagFlux®** is suitable for flow measurement in all kinds of conductive fluids, and it is especially suited for flow measurement of water, waste water, sludge and other fluids containing particles.

The flow meter is easy to install and put into service. However, read this manual first to learn about the **MagFlux®** electromagnetic flow meter and all its features.

You can always contact your local representative or the MJK hot lines for advice and guidance:

- **Europe**      Tel.: +45 45 56 06 56      E-mail: [mjk@mjk.com](mailto:mjk@mjk.com)
- **Denmark**    Tel.: +45 45 56 06 56      E-mail: [mjk@mjk.dk](mailto:mjk@mjk.dk)
- **Norway**      Tel.: +47 69 20 60 70      E-mail: [mjk@mjk.no](mailto:mjk@mjk.no)
- **Sweden**     Tel.: +46 53 31 77 50      E-mail: [kontoret@mjk.se](mailto:kontoret@mjk.se)
- **Holland**     Tel.: +31 251 672171      E-mail: [mjknl@mjk.com](mailto:mjknl@mjk.com)
- **USA**        Tel.: +1 847 482 8655      E-mail: [mjkusa@mjk.com](mailto:mjkusa@mjk.com)
- **Australia**   Tel.: +61 3 9758 8533      E-mail: [mjkaus@mjk.com](mailto:mjkaus@mjk.com)

Visit our web sites at [www.magflux.dk](http://www.magflux.dk) and [www.mjk.com](http://www.mjk.com) to learn more about MJK Automation, our other products and the people behind them.

**MagFlux®** is a registered trademark of MJK Automation A/S, Denmark.

### Trademarks & acknowledgements

M $\mu$  Connect, Connect, MagFlux, Chatter, SuSix, Oxix, pHix and Shuttle are ® registered trademarks of MJK Automation A/S, Denmark.

Expert and Instrument Link are ™ trademarks of MJK Automation A/S, Denmark.

VLT® is a registered trademark of Danfoss A/S.

All other trademarks are the property of their respective owners.

*MJK Automation A/S is a Xylem Brand.*

## About this Manual

The manual is divided into a table of contents, eight chapters, seven appendices and an index.

### 1. Introduction

Contains a presentation of the MJK **MagFlux®** electromagnetic flow meter, the structure of this manual and the operating principles.

### 2. Safety, Repair and Product Identification

Provide answers to issues regarding safety, mounting, repair, restrictions and product identification.

### 3. Flow Sensor

Describes the physical specifications and installation guidelines for the flow sensor such as liner and electrode selection, example pipe systems, sizing chart, etc.

### 4. Flow Converter

Describes the physical specifications and installation rules for the flow converter such as power supply, in- and outputs, sensor/converter/display configurations, etc.

### 5. System Configuration Examples

Illustrates how **MagFlux®** sensors, converters and display units can be interconnected in real-life scenarios.

### 6. Startup

Describes important checks and basic settings to get started including the display and keyboard user interface.

### 7. MagFlux Menus

Contains a comprehensive description of the **MagFlux®** menus, options and utilities.

### 8. Mechanical Dimensions

Lists the flange and sensor dimensions and specifications.

\* \* \* \* \*



**Appendix A. Pop-up Events / Error Messages**

Lists possible pop-up messages, explains their meaning and offer solutions to error conditions.

**Appendix B. MJK-Field Link Software Upgrade**

Describes in detail how to utilise the unique and intuitive MJK-Field Link software program to upload new display and converter firmware versions.

**Appendix C. FAQs - Frequently Asked Questions**

Contains answers to questions that are often asked.

**Appendix D. Front Panel Cut-out Drawing**

A 1:1 scale drawing of the front panel outline and cut-out area for installation and mounting purposes.

**Appendix E. Test Certificate**

Shows an example test certificate which is part of **MagFlux®** shipments.

**Appendix F. Log Files**

An example log file illustrates the format and explains the entries.

**Appendix G. Digital Input/Output Connections**

Illustrates how the digital in- and outputs can be interconnected.

\* \* \* \* \*

**Main Menu Overview**

Is a continuous presentation of the main menu structure. The size of this manual does not provide sufficient space for showing the complete menu structure in one image.

**Converter Setup Menu Overview**

Is a continuous presentation of the converter setup menu structure.

**Service Menu Overview**

Is a continuous presentation of the service menu structure.

**Display Setup Menu Overview**

Is a continuous presentation of the display setup menu structure.

## Operating Principles

The electromagnetic flow meter is an instrument for measuring the flow of conductive fluid using Faraday's electromagnetic induction law, and consequently the fluid must be electrically conductive.

As illustrated below a magnetic field with density  $B$  - perpendicular to the direction of flow - stretches across a fluid flowing within an electrically isolated pipe.

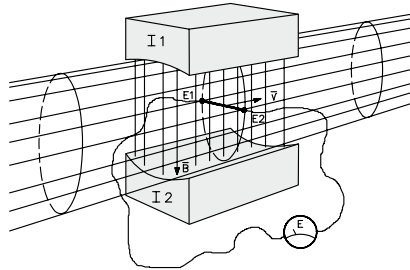

The magnetic flux will induce a voltage difference ( $E$ ) that can be measured between two electrodes arranged perpendicular to the direction of flow and the magnetic field. The voltage is proportional to the velocity ( $V$ ) of the fluid.

①  $E = B \times D \times V \times k$  [Volt] where

$E$  is the voltage that is induced between the two electrodes

$B$  is the magnetic flux density

$D$  is the distance between the two electrodes

$V$  is the fluid velocity

$k$  is a dimensionless constant

The flow of the fluid  $Q$  ( $m^3/s$ ) is given by the following formula:

②  $Q = \pi \times D^2 \times V / 4 \Rightarrow V = 4 / (\pi \times D^2)$  where

$\pi$ : is the constant pi ( $\approx 22/7$ )

$D$ : is the internal diameter

$V$ : is the fluid velocity

The combination of above formulas ① and ② gives the following formula:

$$E = K \times B \times D \times Q \times 4 / (\pi \times D \times D) = 4 K \times B \times Q / (\pi \times D)$$

Evidently the voltage  $E$  is proportional to the actual flow.

## The **MagFlux®** Flow Meter

### Measurement

Electromagnetic flow meters may have either direct current (DC) or alternating current (AC) excitation.

When systems are AC excited, electrostatic and/or electromagnetic noise may influence the measurements. A DC excited system however, is less sensitive to noise produced by electromagnetic induction, simply because the voltage induced over the electrodes will be a DC voltage. The drawbacks are measurement errors due to electro-chemical polarization between the electrodes and the fluid.

The **MagFlux®** electromagnetic flow meters are excited by a 2.5 Hz square wave and thereby eliminate the drawbacks of both DC and AC systems.

A microprocessor receives and measures the amplitude of the pulse with a 16-bit resolution, and converts and displays the result on the display unit.

### Electrode Cleaning

Electrode cleaning is always in service to maintain clean and accurate electrodes. The operating principle is a 55 Hz AC voltage superimposed on the normal 2.5 Hz square wave. This step effectively reduces the risk of a dirt layer build-up on the electrodes that eventually will deteriorate and finally isolate electrical contact to the flow media.

This page intentionally left blank.

## 2. Safety, Repair and Product Identification

### Safety instructions

1. Read this manual carefully.
2. Pay attention to the environment on the installation site.
3. Wear necessary protective equipment and follow all current safety regulations.
4. The **MagFlux®** can invoke a start signal for dangerous machinery. Always ensure that connected machinery and other equipment are effectively put out of service (that is to remove the main fuses and lock main and security switches in off-position) before commencing configuration, fault finding, servicing, maintenance work, etc.
5. **WARNING:** There is a risk of lethal, electrical shock from "Mains supply" terminals N and L. Be careful not to touch these terminals while the **MagFlux®** is being serviced.

### Physical Mounting

The **MagFlux®** flow converter/flow meter **must not** be mounted in explosion hazardous areas!

### Repair

Repair must only be made by MJK or by a service representative approved by MJK.

## Product Identification

A delivery will usually consist of a **MagFlux®** converter and a **MagFlux®** flow sensor. Check that the item(s) delivered corresponds to the ordered item(s). The part number and the calibration code are printed on an identification label stuck onto the flow converter shipping box and on a label on the flow converter itself. The part number, the serial number, the calibration code and the electrode/lining data for the flow sensor are printed on a green name plate (see example below).

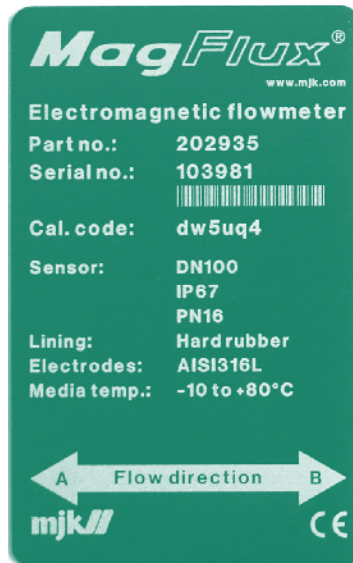

This calibration code (Cal. code) is unique and provides the **MagFlux®** converter with information about flow sensor number, nominal diameter of the flow sensor and calibration data for the flow sensor.

The current converter firmware requires an 8-character input, but it also accepts 6 characters plus two "Ok"s. The example above (dw5uq4) would require that you enter: d w 5 u q 4 "Ok" "Ok", where "Ok" indicates that you press the "Ok" key without selecting any character. Only **small** letters can be entered from the **MagFlux®** keypad.

If changes are needed to the unique sensor calibration code following initial setup, this is the calibration code that the "Sensor Calibration Code" menu must contain (see pages **44** and **86**).

### 3. Flow Sensor

The following conditions must be satisfied to get the full benefit of the **MagFlux®** flow sensor.

#### Minimum conductivity

- The conductivity of the media must be greater than 5  $\mu\text{S}/\text{cm}$ .

#### Liner selection

- Use **Teflon® lining** for chemicals and food industries
- Use **hard rubber lining** for drinking water and waste water
- Use **soft rubber lining** for water with abrasive particles

#### Electrode selection

- **Steel AISI 316TI-1.4571** for general purpose, sewage, water and district heating systems
- **Hastelloy** for sea water
- **Titanium and platinum** for chlorine and other aggressive chemicals

#### Mounting location

- To obtain a stable and accurate flow measurement, it is very important that the flow sensor is mounted correctly in the pipe system
- There must be no flow fluctuations
- Avoid locations where vacuum can occur; especially for flow sensors with Teflon™ linings
- Avoid locations with vibrations from for example pumps
- Avoid locations with extensive temperature changes
- Avoid corrosive environments and locations with a great risk of condensation, or consult factory for special builds for these locations
- Take care that condensate and water cannot enter the connector box on the flow sensor.
- There must be sufficient free space around the flow sensor.
- **IMPORTANT:** Observe that the correct flow direction is set in the **MagFlux®** "Converter Setup" menu and in the "Service Menu". Default flow direction is "A" (flow direction towards left).



The flow directions A or B are clearly shown on the name plate. Default flow direction is "A".

### Pressure loss

The pressure loss can easily be determined, if the nominal pipe diameter is greater than the **MagFlux®** flow sensor. See the diagram below:

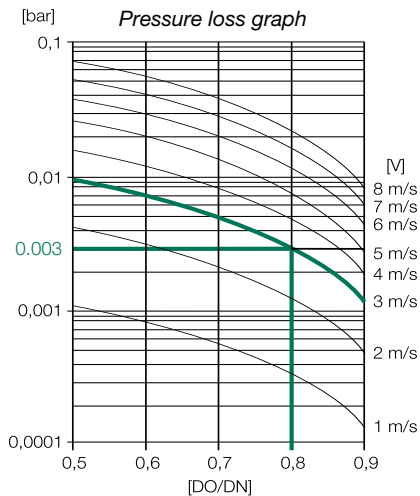

The diagram illustrates that decreasing the internal diameter from 100 mm (DN) to 80 mm (DO) will cause a pressure loss of 0.003 Bar @3 m/s.



### Accuracy

According to the type and size of the flow sensor, the measuring accuracy will be better than 0.25%, provided that the flow sensor has the correct dimension.

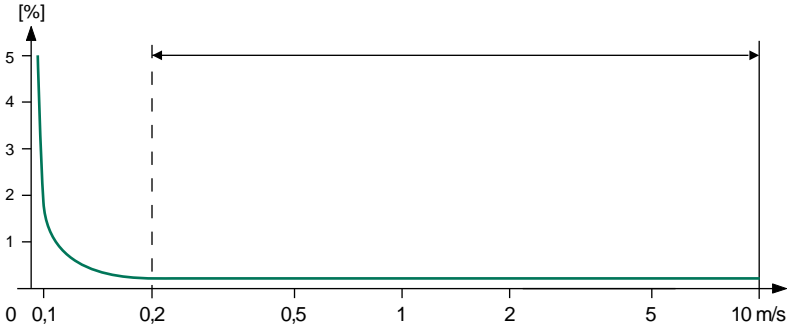

### Sizing

The flow sensor should be selected so the flow velocity through the sensor will be between 0.2 - 10 m/s.

MJK recommends that flow velocities in tubes are kept between 1 - 3 m/s for reliable and safe operation. See also the dimensioning table below and the dimensioning chart on the following page.

Min and max flow								
DN	Qmin	Qmax	DN	Qmin	Qmax	DN	Qmin	Qmax
	0.2 m/s	10 m/s		0.2 m/s	10 m/s		0.2 m/s	10 m/s
	[l/h]	[l/h]		[l/h]	[l/h]		[m³/h]	[m³/h]
3	5.09	254	20	226	11304	65	2,39	119
6	20.4	1018	25	353	17676	80	3,62	181
8	36.2	1810	32	579	28944	100	5,65	283
10	56.5	2827	40	905	45360	125	8,84	442
15	127	6362	50	1414	70560	150	12,7	636

Min and max flow								
DN	Qmin	Qmax	DN	Qmin	Qmax	DN	Qmin	Qmax
	0.2 m/s	10 m/s		0.2 m/s	10 m/s		0.2 m/s	10 m/s
	[m³/h]	[m³/h]		[m³/h]	[m³/h]		[m³/h]	[m³/h]
200	22.6	1131	450	115	5726	900	458	22902
250	35.3	1767	500	141	7069	1000	565	28274
300	50.9	2545	600	204	10179	1200	814	40715
350	69.3	3464	700	277	13854	The Qmax. is equal to 20 mA factory preset		
400	90.5	4524	800	362	18095			

### Sizing Chart

**Example:** A MagFlux with an internal diameter of 100 mm can measure flow rates between approx. 290m<sup>3</sup>/h and 5.6 m<sup>3</sup>/h, and the fluid velocity is 1.5 m/s at a flow rate of approx. 42 m<sup>3</sup>/h.

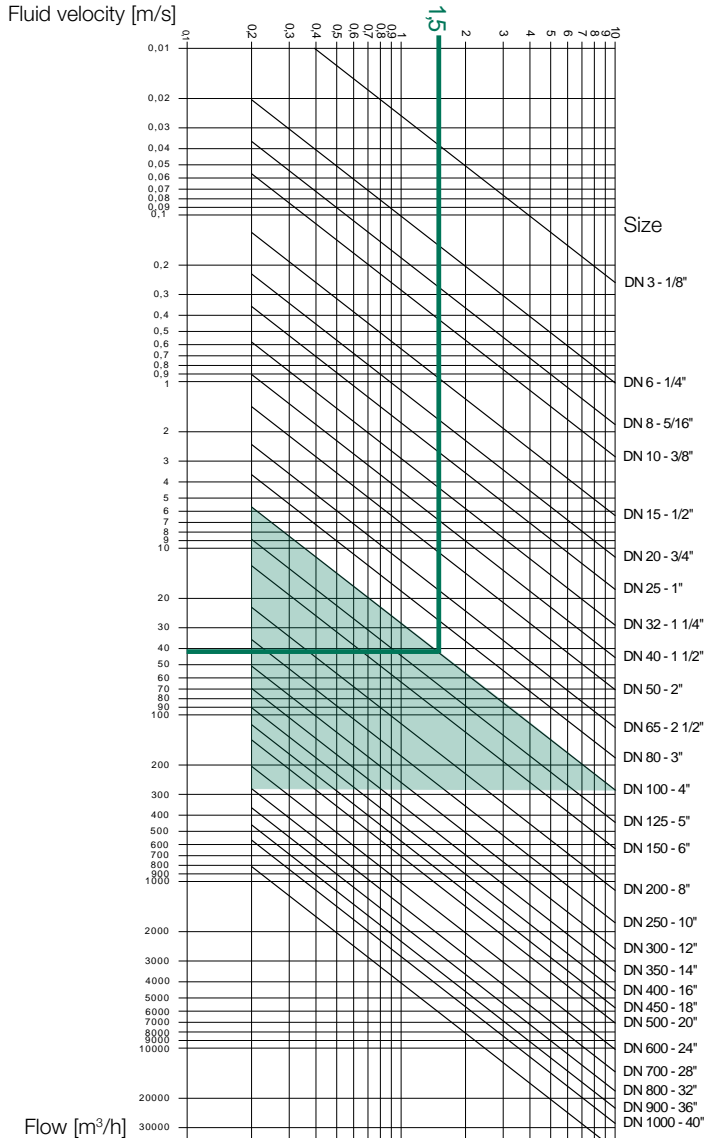

## Pipe System

1. The flow sensor must be mounted in a location which is free from interfering elements like valves, Ts, bends, pumps, etc. to ensure a laminar flow without turbulence upstream of the flow sensor. For that reason the flow sensor must be mounted in a straight pipe at a distance from interfering elements of minimum  $3 \times \text{DN}$  upstream and minimum  $2 \times \text{DN}$  downstream.

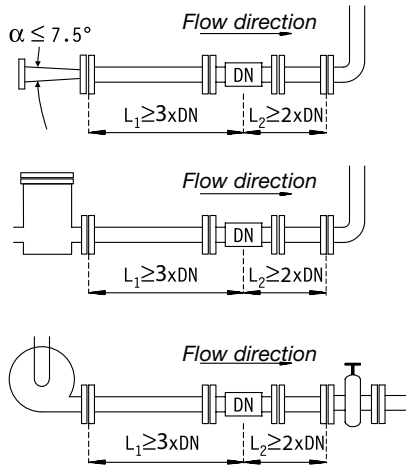

**Important:** Valves should always be mounted on the downstream side of the flow sensor!

- If it becomes necessary to use reducers, the inner angle must not exceed 7.5°.

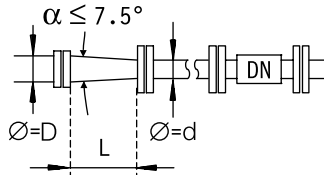

The minimum length to keep the angle below 7.5° can be checked by means of the formula below:

$$L = (D - d) \times 7.63$$

where "D" is the large diameter and "d" the small diameter of the reducer.

*Example: If a flow sensor in dimension DN 80 is mounted downstream of a 100 mm pipe, the reducer must then have a length of minimum 152,6 mm in order to keep the inner angle below 7,5 °.*

- Flange connections must be assembled concentrically on both the upstream and the downstream side. Measuring accuracy will be affected by turbulence in the liquid from poorly made connections.

**Important:** Gaskets and grounding rings must also be mounted concentrically!



- The flow sensor should always be filled with liquid. For that reason the flow sensor must not be mounted at the highest point of the pipe system or in free outlets, where gravity could empty or partially empty the pipe.

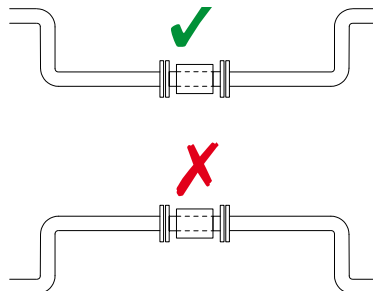

5. The flow sensor can be mounted vertically or horizontally.

If the flow sensor is mounted vertically, the flow direction should always be upwards. In that way the effect from possible bubbles in the liquid will be significantly reduced, just as it will ensure that the flow sensor is always filled with liquid.

In case the liquid is carrying particles, for example when measuring sludge, sewage, etc., the flow sensor must be mounted vertically.

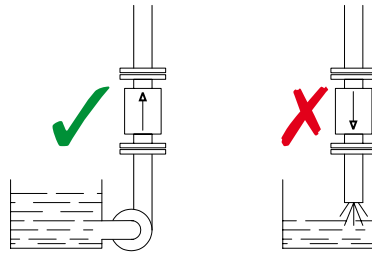

6. When mounting horizontally in pipes with free downstream outlet, the flow sensor should be mounted such that it will always be filled with liquid, for example in a bend situated lower than the height of the outlet.

In case the liquid is carrying particles, e.g. when measuring sludge, sewage etc. the flow sensor must be mounted vertically.

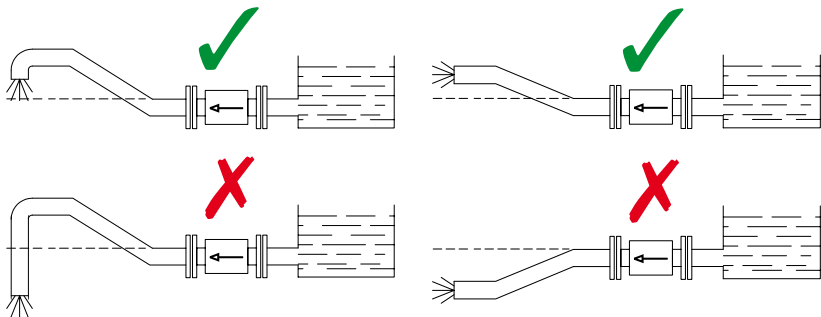

7. When mounting horizontally the flow sensor can be rotated max.  $\pm 45^\circ$  seen from the connection end. If the flow sensor is rotated more than  $45^\circ$ , one of the electrodes may not be in full contact with the liquid.

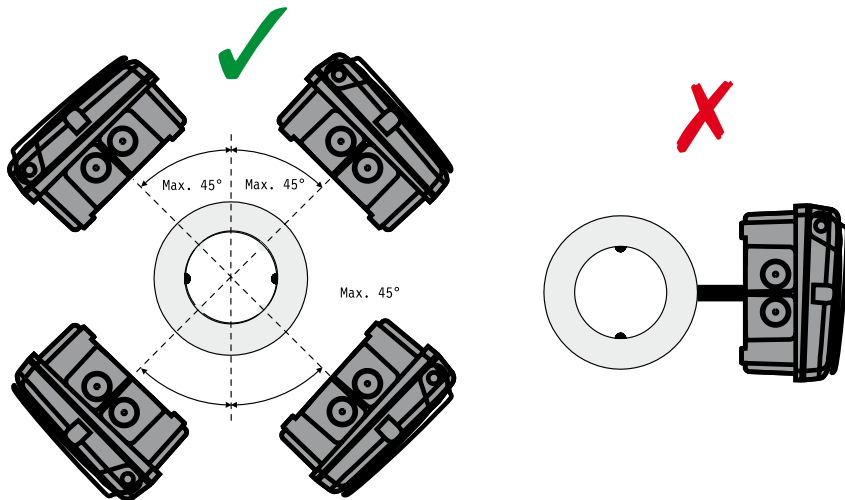

### Cabinet Mounted on the Flow Sensor

The cabinet is mounted on the flow sensor with four pcs. 6x12 hex cap screws.

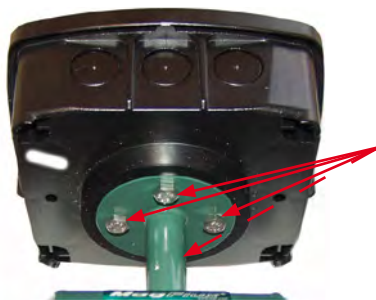

## Potential Equalization and Grounding

### Type 7100/7200/7600 in Conductive Pipes

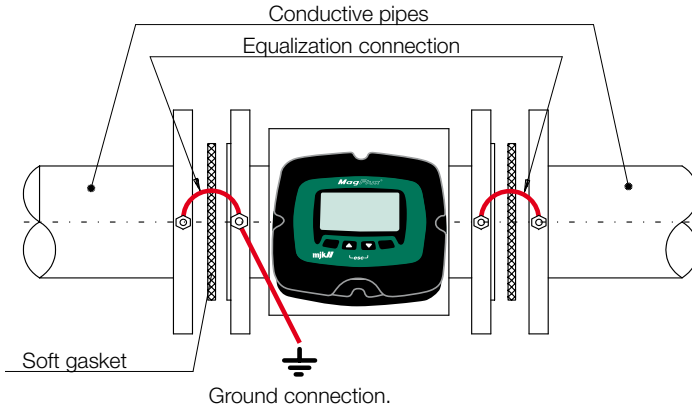

**NB!** The flow sensor must be connected to an effective ground connection, and the wire dimension must be at least 1.5 mm<sup>2</sup>.

### Type 7100/7200/7600 in Non-conductive Pipes

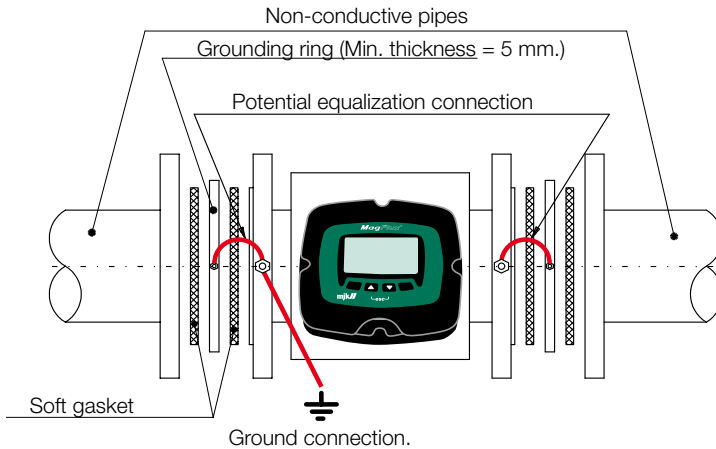

**NB!** The flow sensor must be connected to an effective ground connection, and the wire dimension must be at least 1.5 mm<sup>2</sup>.

## Type 7300/7400 in Conductive Pipes

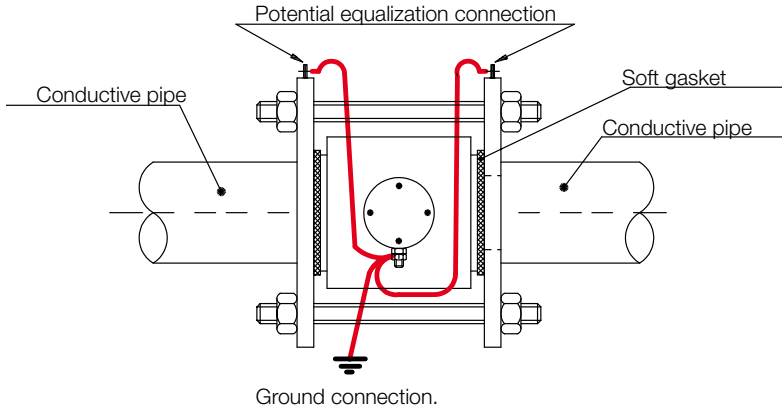

**NB!** The flow sensor must be connected to an effective ground connection, and the wire dimension must be at least 1.5 mm<sup>2</sup>.

## Type 7300/7400 in Non-conductive Pipes

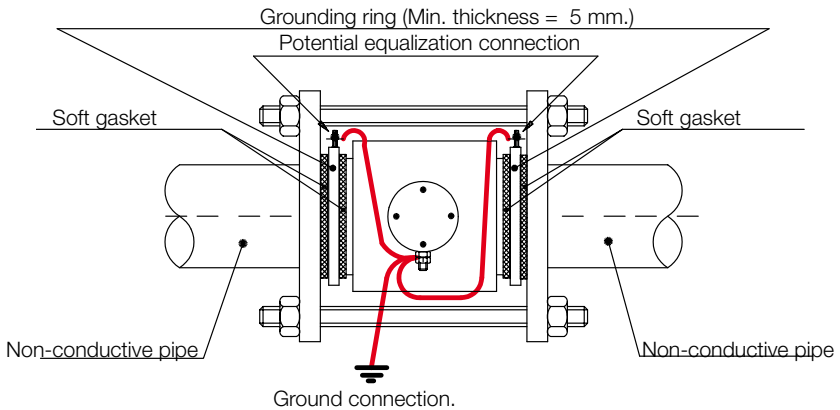

**NB!** The flow sensor must be connected to an effective ground connection, and the wire dimension must be at least 1.5 mm<sup>2</sup>.



## 4. Flow Converter

### Electrical Mounting

**Warning:** The *MagFlux*® flow converter / flow sensor ***must not*** be mounted in explosion hazardous areas!

Loosen the four screws (position indicated by arrows) and remove the display unit to gain access to the terminals.

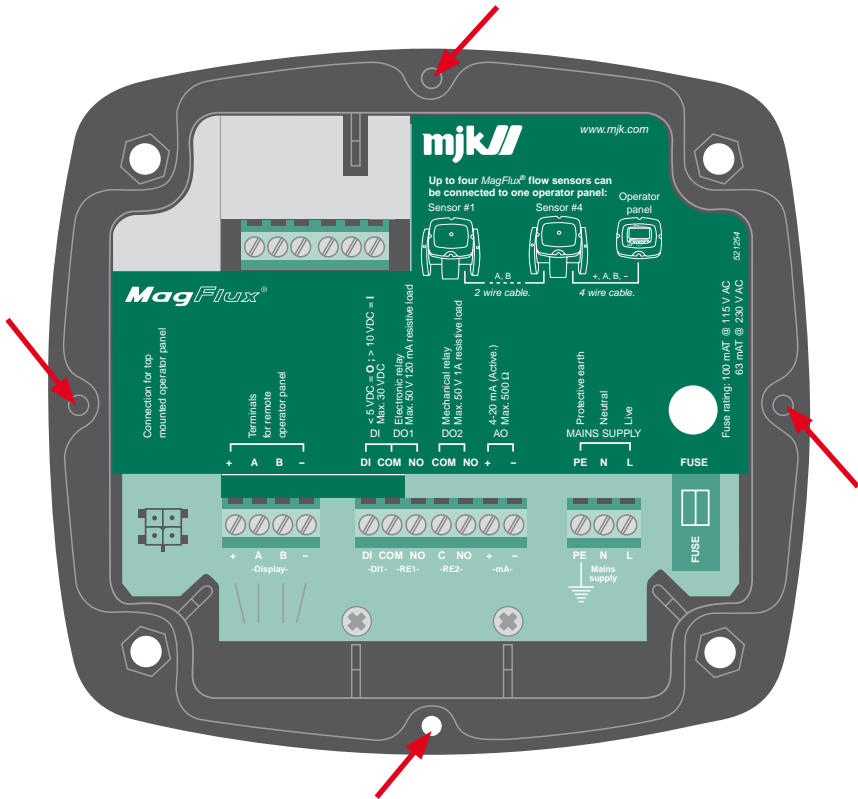

## Power Supply

The flow converter must be supplied from a properly fused mains outlet, a 24 volt AC outlet, or a 10 - 30 V DC power supply/battery.

Power Supply 230 V AC, 115 V AC or 24 V AC		Power Supply 10 - 30 V DC	
Terminal	Designation	Terminal	Designation
PE	Protective ground	PE	Protective ground
N	230 / 115 / 24 V AC neutral	—	DC neutral
L	230 / 115 / 24 V AC live	+	DC live

The internal fuse ratings are:

Internal Fuse Ratings			
Voltage	Rating	Order no.	Dimension
230 V AC	0.063 mA T	550030	5 x 20 mm
115 V AC	0.125 mA T	550035	5 x 20 mm
24 V AC	0.5 mA T	550049	5 x 20 mm
10 - 30 V DC	1.0 AT	550051	5 x 20 mm

The technical specifications/requirements for a 10 - 30 V DC power supply/battery are:

Technical Specifications for 10 - 30 V DC Power Supply	
Power consumption without display	< 5 W
Power consumption with display	< 8 W
Peak start current @12 V DC, 1 second	Approx. 1,5 A
Peak start current @24 V DC, 1 second	Approx. 1 A

## Changing the Power Supply Voltage 230/115 V AC

To change the input mains voltage from 230 VAC to 115 VAC (or vice versa) proceed as follows:

1. Loosen the four screws on the front and lift out the display (see also page 25).
2. Note down the color and position of the wires in the terminal blocks, and then loosen the terminal screws.
3. Unscrew the two screws that hold the metal cover and then remove it.
4. Unscrew the four screws that hold the mother PCB (the printed circuit board with all the electrical components).
5. Remove the mother PCB and look at the back side. This is what you should see (230 V AC configuration):

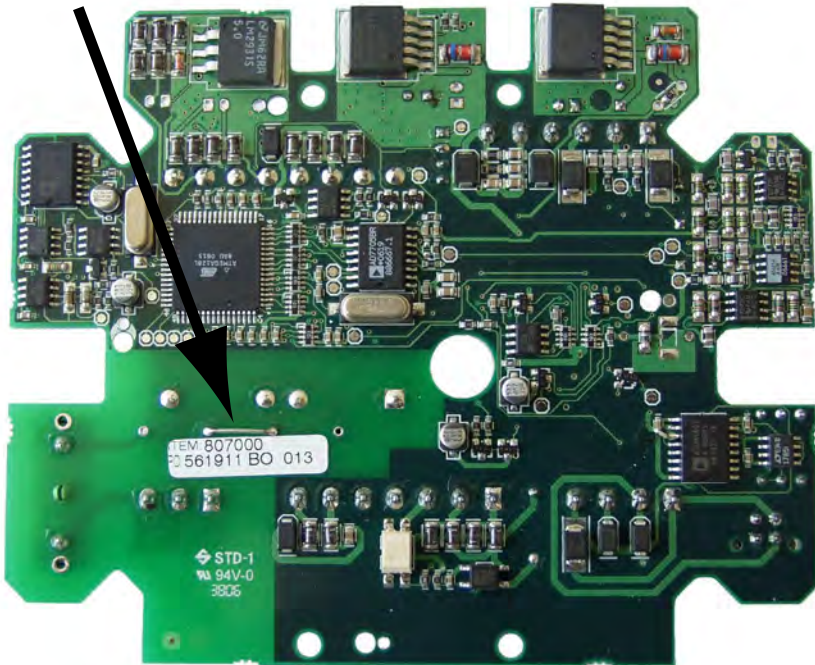

6. Unsolder and remove the jumper indicated by the arrow.

7. Look at the following picture to see where two new jumpers must be inserted (115 V AC configuration):

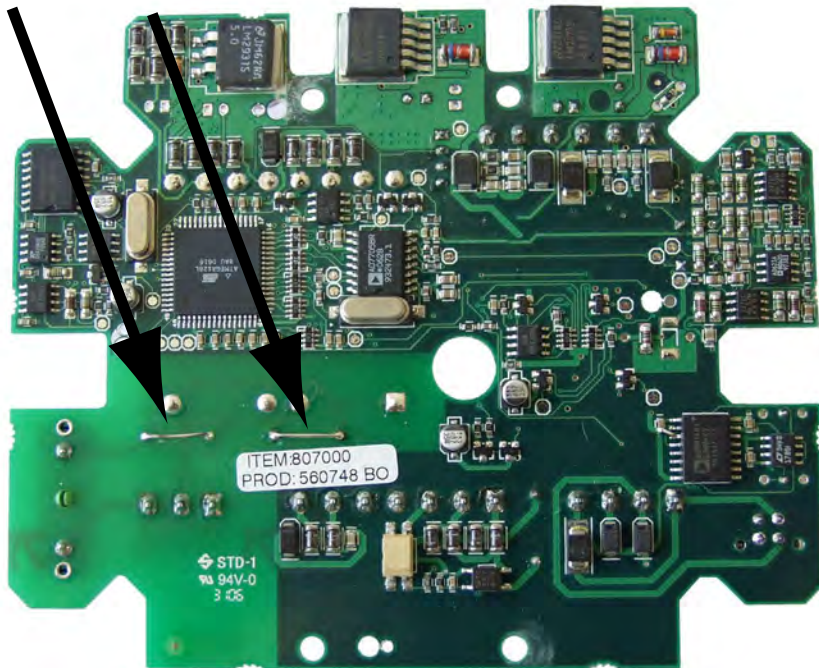

8. Insert and solder 2 jumpers (wires) in the positions indicated by the arrows.
9. Turn around the PCB and replace the 63 mA fuse on the right side with a 125 mA fuse ( or vice versa going from 115 VAC to 230 VAC).
10. Re-insert the PCB and re-assemble the flow meter (see also steps 4, 3, 2 and 1).

## Analogue Output

The analogue output is an active output with a max. load of 800Ω.

Analogue Output		
Terminal		Designation
AO	+	4-20 mA
AO	-	4-20 mA

The analogue output can be programmed for indication of:

- direct flow
- inverse flow
- bidirectional flow
- absolute flow

See details on pages **63** - **66** incl.

## Digital Outputs

**MagFlux®** has two digital outputs - DO 1 with an opto (light triggered) relay and DO 2 with a mechanical relay.

They can both be programmed for the following functions:

- high and low flow alarms
- pulse output for counters R Totalizer Forward and Reverse
- batch 1 and batch 2 counters
- system error alarm
- empty pipe alarm
- flow direction indication

Opto Relay (DO1)		
Terminal		Designation
DO 1	Com	Max. 50 V DC /120 mA
DO 1	NO	

Mechanical Relay (DO2)		
Terminal		Designation
DO 2	Com	Max. 50 V DC /1 A
DO 2	NO	

DO 1 shares the common terminal (Com) with DI.

See also application examples in Appendix G. Digital Input/Output Connections on page **123**.

## Digital Input

**MagFlux®** has one digital input which is activated with a voltage higher than 10 V DC and de-activated with a voltage lower than 5 V DC.

Digital Input		
Terminal		Designation
DI	Com	
DI		Max. 30 V DC

The digital input (DI) can be programmed for the following functions:

- start and pause batch 1 and batch 2 counters
- reset counters R Totalizer Forward and Reverse
- reset counter R Totalizer Sum

DI shares the common terminal (Com) with DO 1.

See also application examples in Appendix G. Digital Input/Output Connections on page **123**.

## Local (compact) Flow Sensor

Connect the compact (local) flow sensor to the flow converter with the wires coming from the flow sensor as shown below.

Compact Flow Sensor			
Terminal	Signal	Designation	Colour from sensor
1 	Liquid GND	Built-in liquid ground electrode	Black/shield
2	E1	Electrode	Red
3	E2	Electrode	White
4	GND	Ground	Black
5	L1	Coil	Blue
6	L2	Coil	Brown
7, 8 and 9		not used	

## Remote Flow Sensor

Connect the remote flow sensor to the flow converter with the included cable (part number 691080).

**Important:** Do not use other cable types!

**Important:** Terminals 1 and 4 must be shunted!

The extension cable length between converter and sensor must under normal circumstances not exceed 50 meters. Power lines running in parallel and noisy environments may reduce the max. length to less than 50 meters. Consult MJK personnel for advice and guidance.

Remote Flow Sensor			691080	
Terminal	Signal	Designation	Colour before March 2011	Colour from March 2011
1	Liquid GND	Shield	-	-
2	E1	Wire pair no. 1	Red	Red
3	E2	Wire pair no. 1	White	White
4	GND	Wire pair no. 3	Black	Black
5	L1	Wire pair no. 2	Green	Blue
6	L2	Wire pair no. 2	White	Brown
7, 8 and 9	not used			

## Converter Connection Board - Local

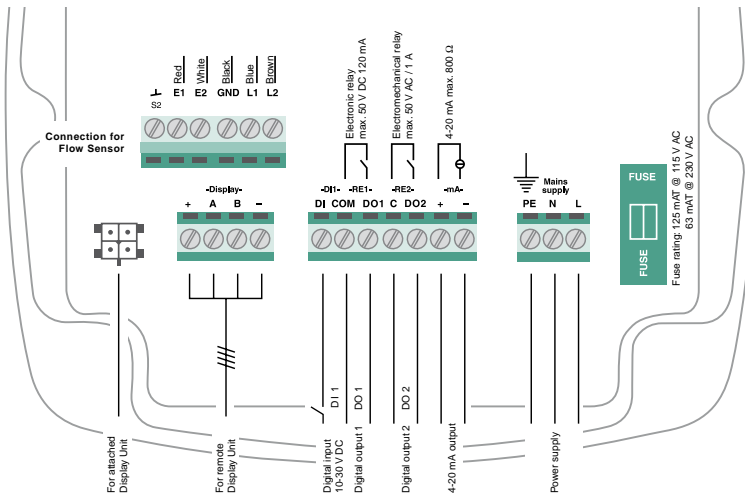

### Converter Connection Board - Remote

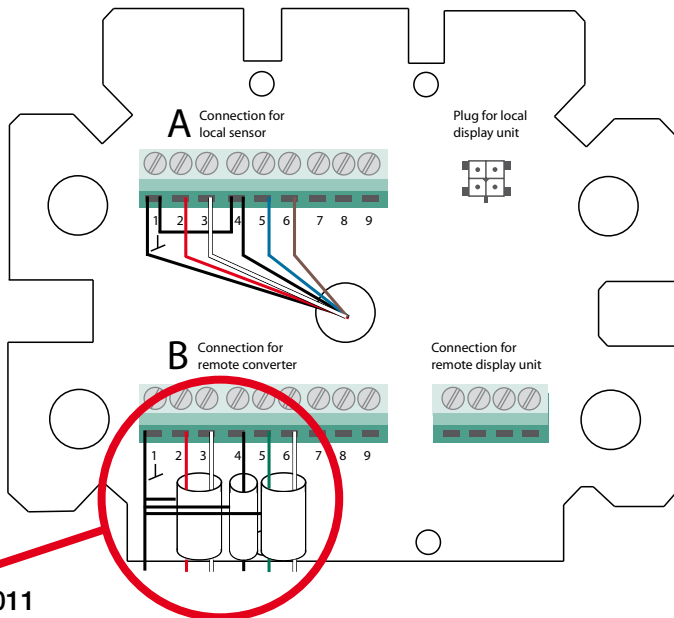

691080 cable  
before March 2011

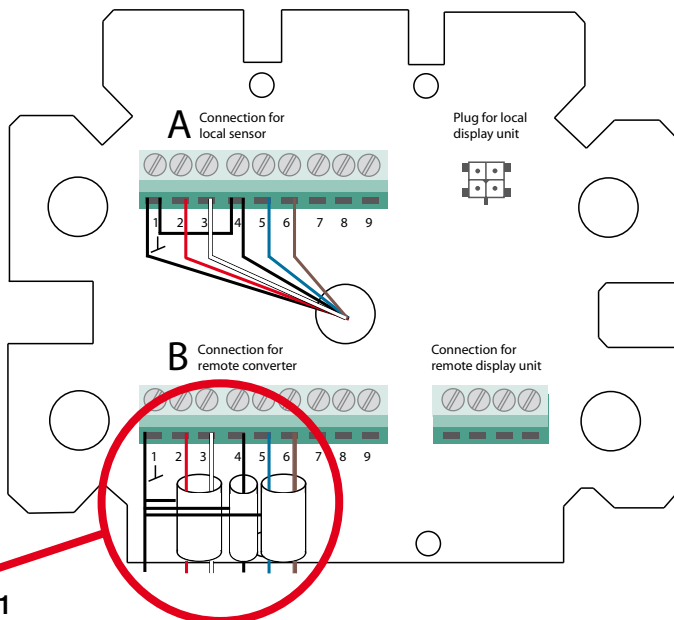

691080 cable  
from March 2011



## 5. System Configuration Examples

### Compact Converter and Display Unit on Flow Sensor

*Configuration: The MagFlux® Converter and Display Unit is mounted directly on the MagFlux® Flow Sensor.*

Order numbers for this configuration:

207xxx **MagFlux®** Flow Sensor

207920 **MagFlux®** Converter with Display Unit for sensor mounting

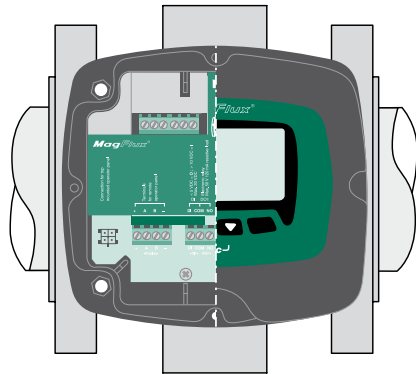

207920 consists of:

- 207940 Display Unit
- 807000 Converter PCB
- 800070 Field Cabinet  
bottom part for sensor  
mounting

### Remote Converter with Connection Box on Flow Sensor

*Configuration: The MagFlux® Converter and Display Unit is remote mounted for example when the sensor is to be buried or submerged.*

Order numbers for this configuration:

- 207xxx **MagFlux®** Flow Sensor
- 207925 **MagFlux®** Converter with Display Unit for wall mounting
- 691080 **MagFlux®** Sensor cable
- 579035 **MagFlux®** Gel Potting Kit IP68

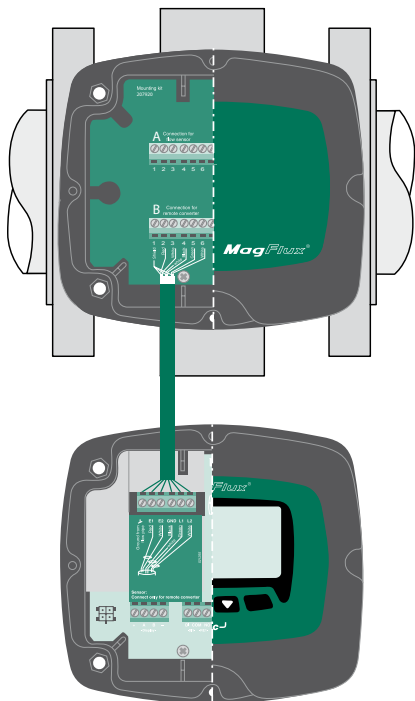
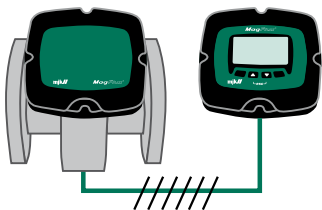

207925 consists of:

- 207940 Display Unit
- 207020 MagFlux connection PCB (see picture below)
- 820050 Blind Lid
- 800070 Cabinet bottom part for sensor mounting
- 800075 Cabinet bottom part for wall mounting

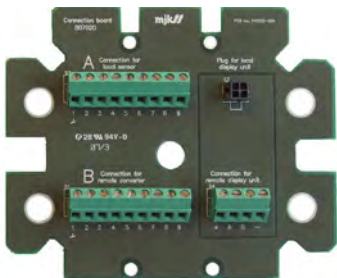

Converter connection PCB

## Wiring Schematic #1

for "Remote Converter with Connection Box on Flow Sensor" on the opposite page (page 34).

### Flow Sensor

Connect one end of the MJK cable to the flow sensor as described in the table below. All 3 shields are twisted and connected in slot 1. The white lead in pair no. 3 is not used.

B Connection for remote converter				
Terminal	Signal	Wire	Colour before March 2001	Colour from March 2011
1	GND	Shield	-	-
2	E1	Pair no. 1	Red	Red
3	E2	Pair no. 1	White	White
4	GND	Pair no. 3	Black	Black
-	-	Pair no. 3	White	-
5	L1	Pair no. 2	Green	Blue
6	L2	Pair no. 2	White	Brown
7, 8, 9			not used	

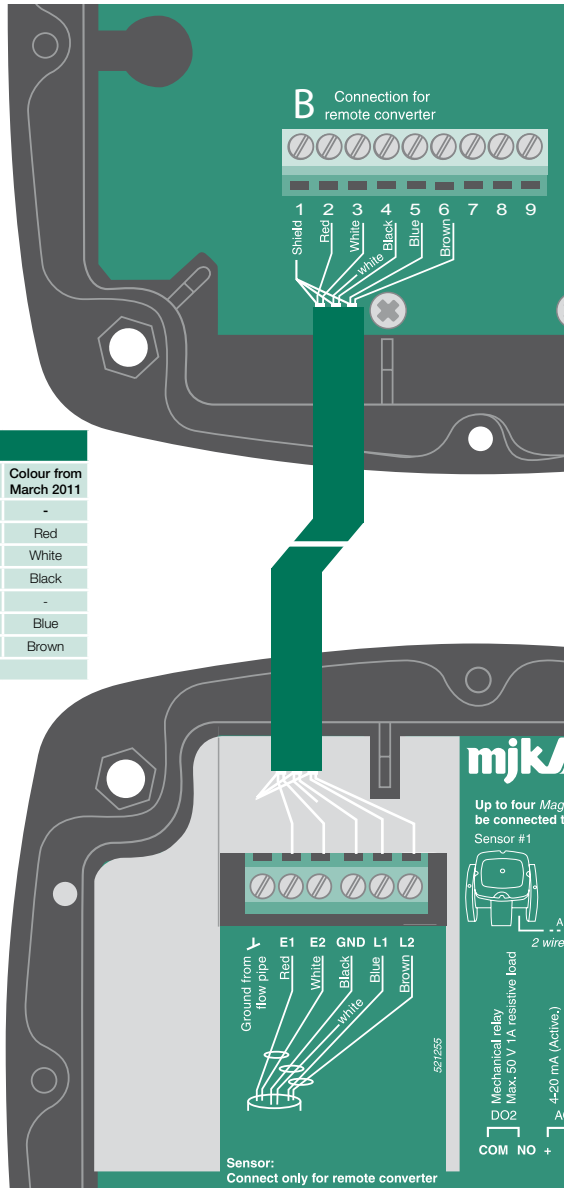

### Remote Converter (and Display Unit)

Connect the other end of the MJK cable to the remote converter as shown to the right. The "1 Shield" lead goes into "Ground from flow pipe", the "2 Red" lead goes into "E1 Red", the "3 White" lead into "E2 White", and so on.

## Remote Display and Multiple Converters Wiring

**Configuration: Two locally mounted MagFlux® Flow Sensors and converters with blind lid and one remote mounted Display Unit.**

The communication between the sensors and the Display Unit is executed on shielded twisted 2- and 4-wire cables using the Modbus® communication protocol on RS-485.

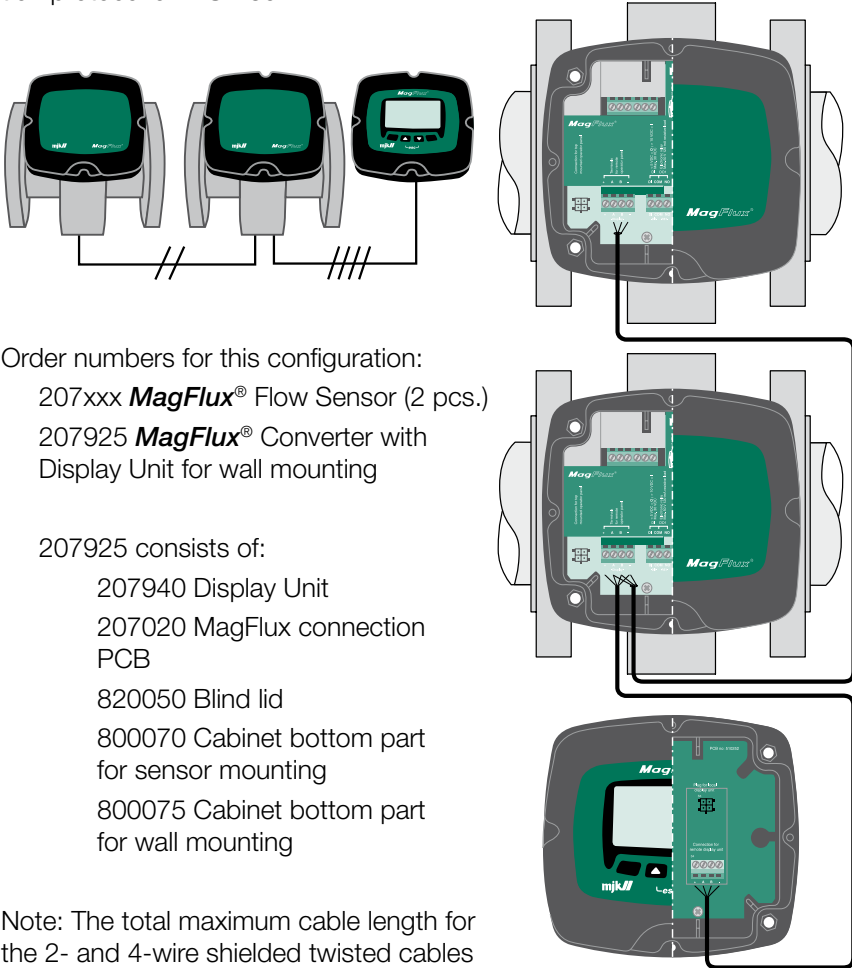

Order numbers for this configuration:

207xxx **MagFlux®** Flow Sensor (2 pcs.)

207925 **MagFlux®** Converter with Display Unit for wall mounting

207925 consists of:

207940 Display Unit

207020 MagFlux connection PCB

820050 Blind lid

800070 Cabinet bottom part for sensor mounting

800075 Cabinet bottom part for wall mounting

Note: The total maximum cable length for the 2- and 4-wire shielded twisted cables is 1000 meters.

## Wiring Schematic #2

for the "Remote Display and Multiple Converters Wiring" example on the opposite page (page 36).

### Local flow sensor 1

*2-wire twisted shield cable:*

Connect lead "1" to slot "A", lead "2" to slot "B" and the twisted shield to slot "-".

### Local flow sensor 2

*2-wire twisted shield cable:*

Connect lead "1" to slot "A", lead "2" to slot "B" and twisted shield to slot "-".

*4-wire twisted shield cable:*

Connect lead "1" to slot "A", lead "2" to slot "B", lead "3" to slot "+" and lead "4" and twisted shield to slot "-".

### Remote display unit

*4-wire twisted shield cable:*

Connect lead "1" to slot "A", lead "2" to slot "B", lead "3" to slot "+" and lead "4" and twisted shield to slot "-".

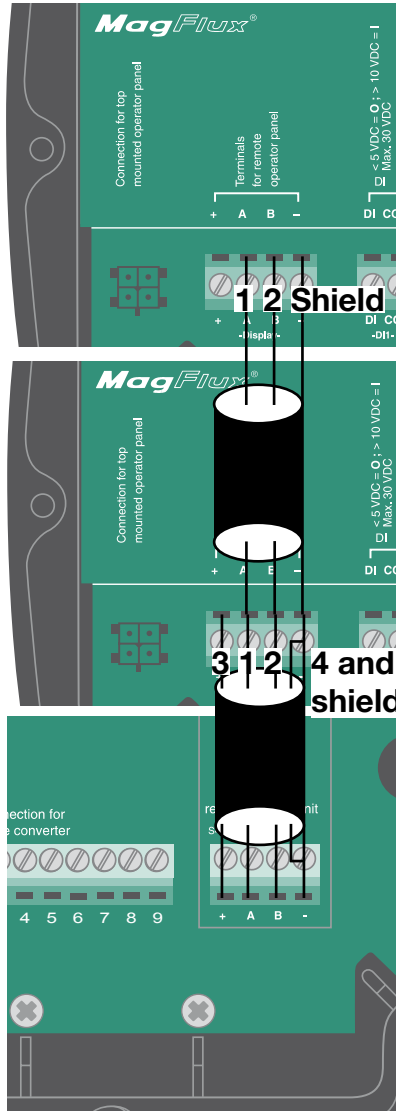

This page intentionally left blank.

## 6. Startup

### Initial Checks

Before switching on power the following steps must be checked.

1. The local mains power supply voltage corresponds to the voltage printed on the identification label of the flow converter.
2. All electrical connections are made in accordance with the electrical connection diagram shown on page **32**.
3. All terminal screws are tightened.
4. All cable glands are tightly secured.
5. All grounding connections are made in accordance with the instructions in this manual (see page **23**).

### Initial Flow Measurement

1. Make sure that the flow sensor is completely filled with liquid.
2. Turn on power to the flow converter and wait one minute.
3. Verify or enter the calibration code of the flow sensor in the "Converter Setup/Service Menu/Sensor Calibration Code" menu (see also page **86**).

If the entered calibration code is incorrect, and for example indicates a wrong internal diameter, read the correct calibration code on the converter as explained on page **14**.

### Flow Direction Check

1. Allow free flow through the sensor.
2. Check on the display unit screen that the flow value increases. If the value goes negative, check that the "Flow direction" option is set correctly and/or check the electrical connections on the flow sensor.

### Language Selection

1. The default display language is English. If another language is required, proceed with step 2.
2. Select "Display Setup" from the Main Menu.
3. Select "Language" from the Display Setup menu and chose the required language (see page **96**).

## Display Read-out, one connected unit

All **MagFlux**® display read-outs are illustrated and described in this manual.

Chapter 6. MagFlux Menus (on page 47) gives a detailed description of the displays shown during setup, configuration and normal operation.

A 5-line LCD screen displays symbols and the actual status during setup, configuration, servicing and normal operation (see also page 48).



Keyboard for reading and programming the MagFlux

The display shown above will in the remaining part of this manual be stylized to appear like this:

MagFlux	
Flow	4.1 m <sup>3</sup> /h
FTot	18.77 m <sup>3</sup>
Select	Setup



## Display Read-out, several connected units

When several MJK units are interconnected, for example an Oxix® dissolved oxygen transmitter and MagFlux® flow meter with different names and Modbus ID numbers, a "Display Overview Menu" is available at top level (press "Back" repeatedly):

MagFlux	4.1 m <sup>3</sup> /h
Oxix1	91.9 %
Back	Select    Setup

All connected units are displayed and sorted by their ID numbers, and consequently each unit can be selected and set up as required:

MagFlux	
Flow	<b>4.1</b> m <sup>3</sup> /h
FTot	18.77 m <sup>3</sup>
Select	Setup

or

Oxix1	
Oxygen sat.	<b>91.9</b> %
Select	Setup

### Important:

**More connected units can only be managed as described above, if each unit have been assigned a unique name and Modbus ID number. See page 98 for details.**

## Display Keys

The keys and the soft keys (variable key functions determined by the display firmware) are used for initial programming and normal operation of the flow meter.

The function(s) of the four available keys is displayed at the bottom of the display. The symbols and actual functions are described in detail in the sections that describe the individual menus.

## Contrast Adjustment

Adjust the display contrast by pressing the two outmost keys simultaneously (indicated by the keys) and press the up/down keys as required.



Save the new setting by pressing the two outmost keys simultaneously.

## System Reset

You can reset and refresh all system displays and key combinations by pressing all four keys simultaneously.

This feature is especially useful during for example a service call, where the display language (Dutch, Danish, etc.) cannot be understood by the service person. A system reset immediately sets the display language to (GB) English.

The system reset must not be confused with the ultimate "Recover factory settings" (see page **100**) which deletes all local configurations/settings and replaces them with default factory settings.

## Initial Setup

Initial setup is normally performed by MJK personnel and is required to get started with the **MagFlux®** flow meter.

A unique sensor calibration code provides the **MagFlux®** flow converter with information about flow sensor number, nominal diameter and calibration data.

If changes to the unique sensor calibration code are needed following physical installation and initial setup, the "Sensor Calibration Code" menu must be addressed.

A password is not required to enter or change the sensor calibration code. Toggle through the displayed digits with the right-arrow key when prompted for a password and press OK.

1. Press the "Setup" key on the LCD display (see below) to enter the **MagFlux®** Main Menu.

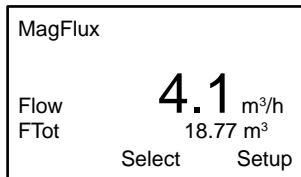

2. Press the up/down keys to highlight the required menu line (here: "Converter Setup") and then press OK to select it.

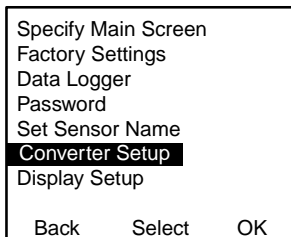

3. Then select "Service Menu" and "Sensor Calibration Code".

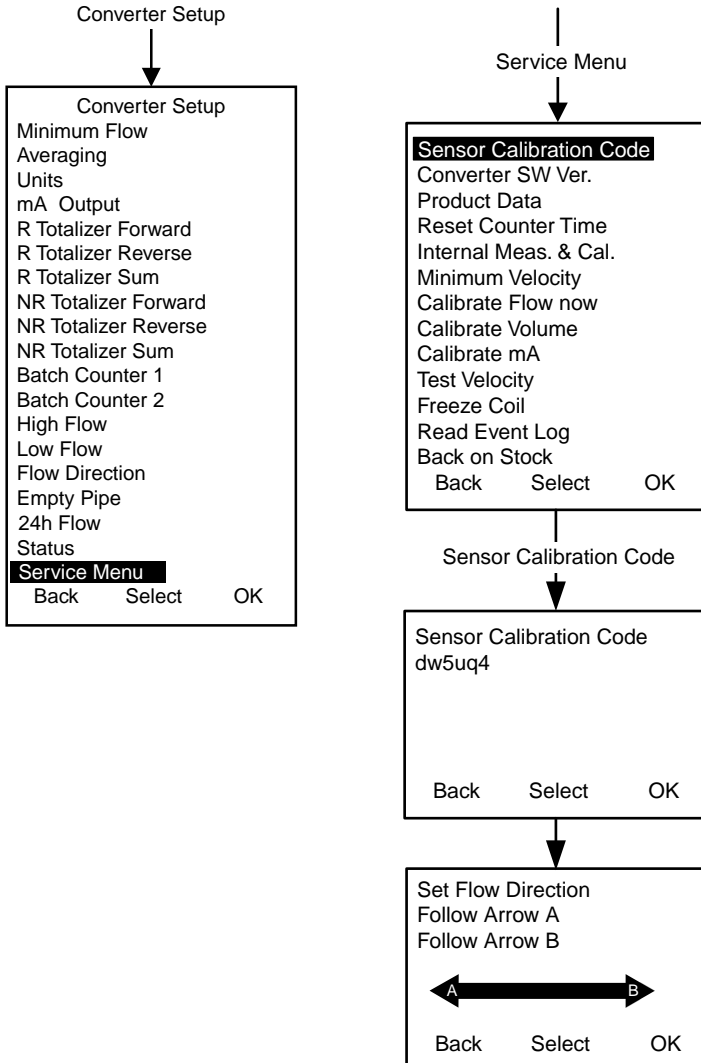

4. Enter the calibration code read from the converter label (or pass through or change the displayed calibration code) and then press OK. See also details regarding the calibration code on page 14.
5. Select the correct flow direction in the "Set Flow Direction" menu and press OK.

6. Pass through the "DN" menu and press OK.

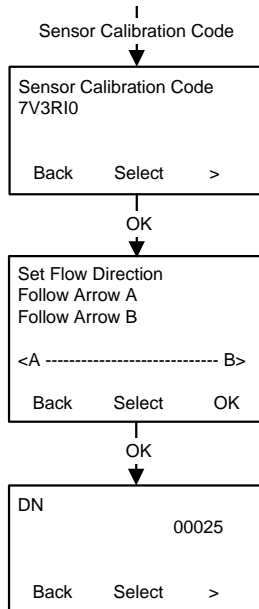

The **MagFlux®** is now configured with default settings and is ready for use.

**Note: If the sensor has not been pre-configured from the factory with a sensor calibration code, the calibration code procedure is somewhat different from the just mentioned.**

See the steps on the following page to configure a non-configured sensor with a calibration code.

1. Apply power to the sensor.
2. When the "Sensor Calibration Code" menu appears (see below), enter the calibration code read from the converter label and press OK.

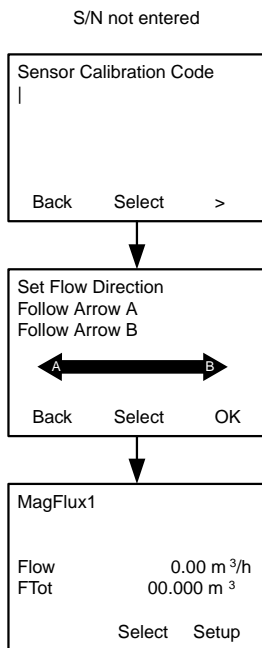

3. Select the correct flow direction from the "Set Flow Direction" menu and press OK.
4. Sensor calibration code configuration is now finished, and you are returned to the Main Menu.

## 7. MagFlux Menus

All the **MagFlux**® menus and sub menus are shown and described in the following sections.

Continuous overviews of the menu and sub-menu structures are presented on the gatefolds at the end of this manual:

- **Main Menu Overview** (page Gf-1)
- **Converter Setup Menu Overview** (page Gf-2)
- **Service Menu Overview** (page Gf-3)
- **Display Setup Menu Overview** (page Gf-4)

### Main Menu

1. Press the "Setup" key on the **MagFlux**® display (see below) to enter the **MagFlux**® Main Menu.

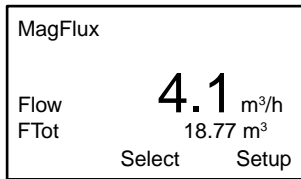

The **MagFlux**® Main Menu contains a number of sub menus (see figure below).

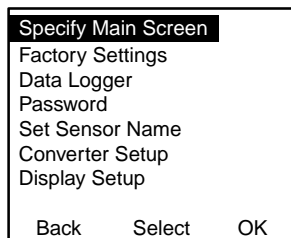

2. Press the up/down keys to highlight the required menu line (here: Specify Main Menu) and then press OK to select it.

## Specify Main Screen

The "Specify Main Screen" menu allows you to customize the **MagFlux**® display to suit your requirements. You can add and remove the five available display lines and configure them individually.

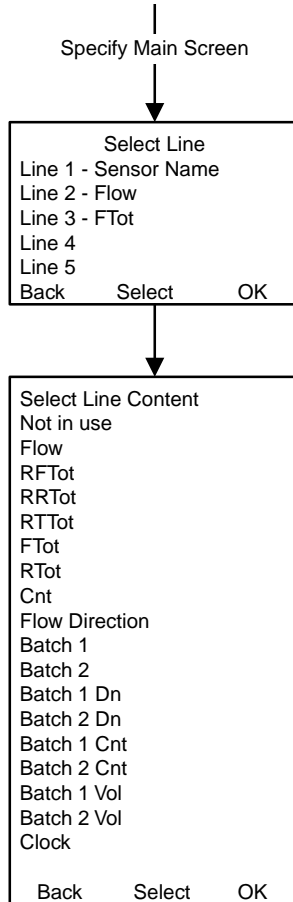

1. Press the up/down keys to highlight the required menu line and then press OK to select it.
2. Press the up/down keys to highlight the required option and press OK.



The available options are:

**Not in use**

The line will not be used. The set free space will be used by the other lines.

**Sensor Name**

The actual sensor name like a number, a location, a name or a function will be displayed

Note: The actual sensor name is defined later on in the "Set Sensor Name" menu on page 59.

**Flow**

Actual flow rate (in units chosen in the menu for primary units).

**RFTot**

Resettable **F**orward **T**otalizer counter

32bit (unit L) 4 294 967 295 L

**RRTot**

Resettable **R**everse **T**otalizer counter

32bit (unit L) 4 294 967 295 L

**RTTot**

Resettable **T**otal **T**otalizer counter

32bit (unit L) 2 147 483 647 L (+/- half of Tot)

**FTot**

Forward **T**otalizer counter

64bit (unit mm<sup>3</sup>) 18 446 744 073 709 551 615 mm<sup>3</sup>

**RTot**

Reverse **T**otalizer counter

64bit (unit mm<sup>3</sup>) 18 446 744 073 709 551 615 mm<sup>3</sup>

**Cnt**

Totalizer sum **C**ounter

64bit (unit mm<sup>3</sup>) 9 223 372 036 854 775 807 mm<sup>3</sup> (+/- half of Tot)

**Flow Direction**

Flow direction "A" or "B" will be displayed.

**Batch 1**

Timer for batch volume 1

**Batch 2**

Timer for batch volume 2

**Batch 1 DN**

Displays the missing amount of **Batch** volume **1** (DN = down)

**Batch 2 DN**

Displays the missing amount of **Batch** volume **2** (DN = down)

**Batch 1Cnt**

**Batch 1 Counts** (number of batches)

**Batch 2 Cnt**

**Batch 2 Counts** (number of batches)

**Batch 1 Vol**

**Batch 1 Volume**

**Batch 2 Vol**

**Batch 2 Volume**

**Clock**

Time and date

The size of the display lines will automatically increase or decrease as the number of display lines is removed or added to maximize the field of view for the measured values

## Factory Settings

The "Factory Settings" menu resets the display to default settings, to metric settings or to US settings.

**Note:** *The converter settings are not changed from this menu. Converter settings are covered in "Converter Setup" on page 61.*

1. Press the up/down keys to highlight the required menu line (here: Factory Settings) and then press OK to select it.

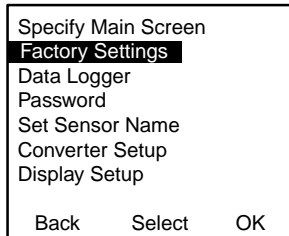

2. Press the up/down keys to highlight the required option and then press OK to select it.

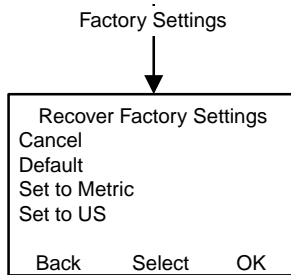

The available options are:

### Cancel

Exit the menu without changes.

**Default**

When "Default" is selected, the following settings **are not** affected and remain as chosen by the user:

- Sensor Name
- Device ID
- Flow Direction
- DN, size
- Calibration
- Calibration Code

The in- and outputs are **not** activated from the factory. Activate the in- and outputs by configuring the functions with for example the default values shown in the following tables:

- MagFlux Default DI/DO Settings
- MagFlux Default 20 mA Settings

MagFlux Default DI/DO Settings		
Digital Output 1 (opto) - DO1	Digital Output 2 (mech.) - DO2	Digital Input - DI
Counter R Totalizer Forward	Counter R Totalizer Forward	RESET R Totalizer Forward
Counter R Totalizer Reverse	Counter R Totalizer Reverse	RESET R Totalizer Reverse
Batch Counter 1	Batch Counter 1	RESET R Totalizer Sum
Batch Counter 2	Batch Counter 2	Start / Pause Batch counter 1
Low Flow	Low Flow	Start / Pause Batch counter 2
High Flow	High Flow	
Flow Direction	Flow Direction	
Empty Pipe	Empty Pipe	

Note: The same function can not be on assigned to both relays.

MagFlux Default 20 mA Settings			
Metric		US	
DN [mm]	Flow [m3/h]	Size	Flow [GPM]
3	0,25		
6	1	1/4"	10
8	2		
10	5	3/8"	10
15	5	1/2"	30
20	10	3/4"	50
25	20	1"	75
32	30	1 1/4"	100
40	50	1 1/2"	200
50	75	2"	300
65	100	2 1/2"	500
80	200	3"	800
100	300	4"	1000
125	400	5"	2000
150	600	6"	3000
200	1000	8"	5000
250	2000	10"	7700
300	2500	12"	10000
350	3000	14"	10000
400	4500	16"	20000
450	6000	18"	25000
500	7000	20"	30000
600	10000	24"	40000
700	15000	28"	60000
800	20000	32"	80000
900	25000	36"	100000
1000	30000	40"	100000
1200	40000	48"	200000

### Set to metric

All converter-related units can be set to the following units (default values in bold italics):

Flow Unit	Totalizers					
m <sup>3</sup> /sec	RFTot	RRTot	RSTot	FTot	RTot	Cnt
l/sec	l	l	l	<i>l</i>	<i>l</i>	<i>l</i>
l/min	hl	hl	hl	hl	hl	hl
l/h	kl	kl	kl	kl	kl	kl
<b><i>m<sup>3</sup>/h</i></b>	<b><i>m<sup>3</sup></i></b>	<b><i>m<sup>3</sup></i></b>	<b><i>m<sup>3</sup></i></b>	m <sup>3</sup>	m <sup>3</sup>	m <sup>3</sup>

### Set to US

All converter-related units can be set to the following units (default values in bold italics):

Flow Unit	Totalizers					
ft <sup>3</sup> /h	RFTot	RRTot	RSTot	FTot	RTot	Cnt
MGD	ft <sup>3</sup>	ft <sup>3</sup>	ft <sup>3</sup>	<b><i>ft<sup>3</sup></i></b>	<b><i>ft<sup>3</sup></i></b>	<b><i>ft<sup>3</sup></i></b>
<b><i>GPM</i></b>	<b><i>gal</i></b>	<b><i>gal</i></b>	<b><i>gal</i></b>	gal	gal	gal
	MG	MG	MG	MG	MG	MG

## Data Logger

Magflux® provides a data logger with a capacity of approx. 20,000 entry points. See Appendix E on page 120 for examples and descriptions of log files.

The data logger operates after the FIFO principle (First In, First Out). If the data logger is full and new data are coming in, the oldest data are discarded.

1. Press the up/down keys to highlight the required menu line (here: Data Logger) and then press OK to select it.

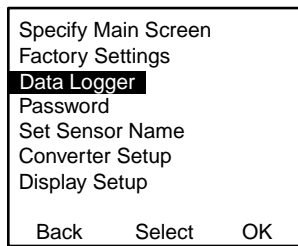

2. Press the up/down keys to change the highlighted digit, and then press the right-key (>) to proceed to the next digit.

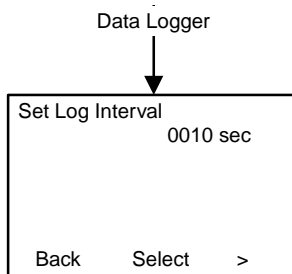

3. Continue until all digits have been set and press OK.  
The log interval can be set in intervals from 10 sec. up to 9999 sec.

The data log contains:

- Date
- Time
- Flow values

In case of a power failure, the data logger continues when power returns. If more converters are connected to one Display Unit, each converter has its own individual log interval and can be sorted.

All converters share the same memory of 160.000 entry points.

The log data can be shown on the Display Unit or be stored in an external CSV file. MJK-Field Link software is needed for transfer of data into CSV file format via the USB port in the display unit. The format can be read in for example Microsoft® Excel® (see Appendix B on page 120 for details).

An example of the log capacity of one sensor versus the time interval is shown in the following table.

Log interval		Log capacity	
Seconds	Minutes	Hours	Days
10	-	444,45	18,51
30	-	1333,34	55,55
-	1	2667	111
-	5	13333	555
-	10	26667	1111
-	30	80000	3333
-	60	160000	6667



## Graph Display

The content of the Data Logger can be displayed on the Display Unit by pressing the up/down keys simultaneously (esc), highlighting "Flow" and selecting "Graph"

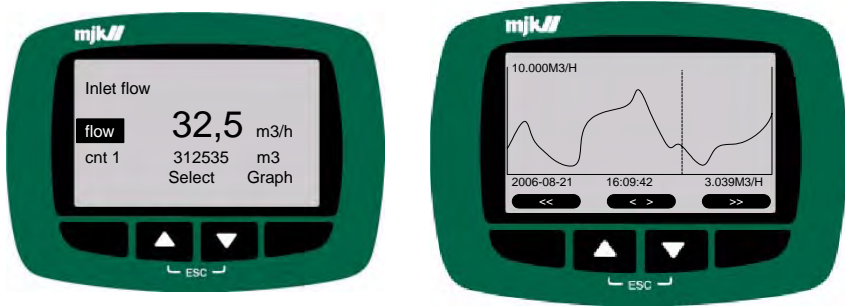

The Display Unit then shows the Graph screen. To return to the Main Menu display screen, select "esc" by pressing the up/down keys simultaneously.

The Y axis is automatically scaled according to the  $Q_{max}$  of the mA output. Double-arrow keys jump forward and backward one screen frame at a time. Single-arrow keys move the cursor forward and backward on the screen.

The actual values at the cursor position is shown at the bottom of the screen.

## Password

A password provides (and prevents) access to all the settings in the Display and Converter unit. The code consists of a numeric 5-digit code between 0 and 65535. If your current password is lost or forgotten, the password protection can be overruled with the code "01750".

1. Press the up/down keys to highlight the required menu line (here: Password) and then press OK to select it.

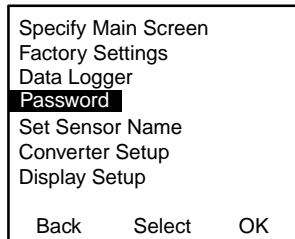

2. Press the up/down keys to highlight the required option and then press OK to select it.

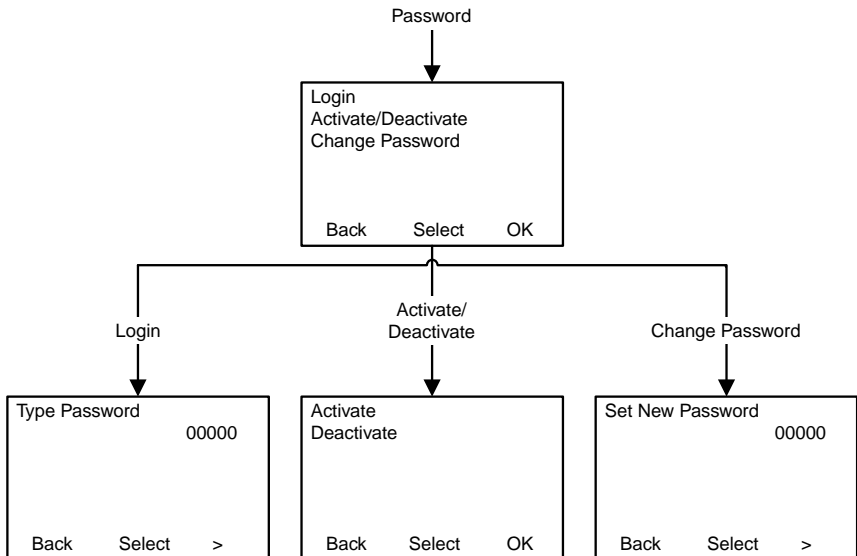

The available options are:

### Login

Use the up/down keys to set the digits one by one. Continue with > until all digits have been set and then press OK.

### Activate/Deactivate

Write protection. Selecting "Activate" means that a password must be entered to change vital settings. "Deactivate" disables password protection. If your current password is lost or forgotten, the password protection can be overruled with the code "01750".

### Change Password

The present 5-digit password can be changed as required.

### Set Sensor Name

A unique name and/or number, a function or a location can be assigned for a sensor (here: "MagFlux1"). It is consequently shown on the main display with up to 4 display lines.



1. Press the up/down keys to highlight the required menu line (here: Set Sensor Name) and then press OK to select it.

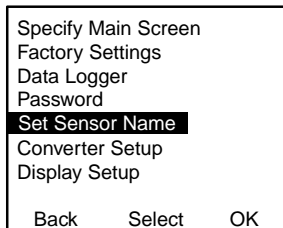

- To change the default sensor name (MagFlux1), press the left/right keys to highlight the wanted character.

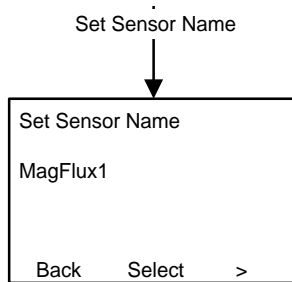

- Press the up/down keys to change the highlighted character and then press > to proceed to the next character.
- Continue with > until all numeric and alphabetical characters have been set to for example "Inlet flow" (see below).
- Press OK.



The available characters depend on the chosen language. English, for example, provides the following character set:  
a b c d e f g h i j k l m n o p q r s t u v w x y z A B C D E F G H I J K L M N O P Q R S T U V W X Y Z <space> 1 2 3 4 5 6 7 8 9 and 0.

## Converter Setup

"Converter Setup" provides configuration options for volumes, batches, units, etc. See detailed descriptions in the following sections and in the overview pages at the end of this manual.

1. Press the up/down keys to highlight the required menu line (here: Converter Setup) and then press OK to select it.

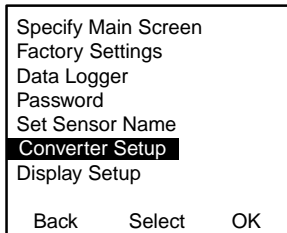

2. Press the up/down keys to highlight the required option and then press OK to select it.

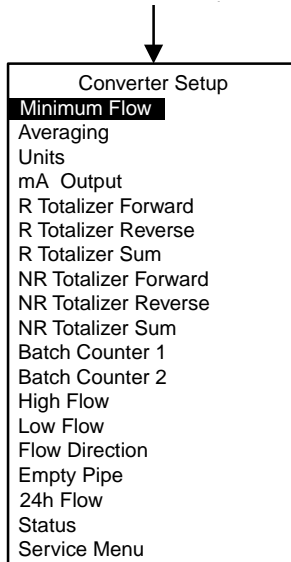

The available options are described in detail in the following sections.

## Minimum Flow

The "Minimum Flow" option sets the minimum flow rate.

**Magflux®** flow meters are default set to the values shown on page 17.

The unit for the flow rate can be set from the "Units" option (see page 64).

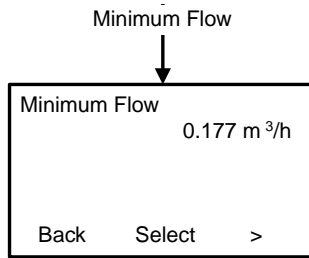

1. Select the digits one by one with the left/right keys and set the value with the up/down keys.
2. Press OK to save the final setting.

## Averaging

The "Averaging" option sets the time period within which the measurements are smoothed and averaged.

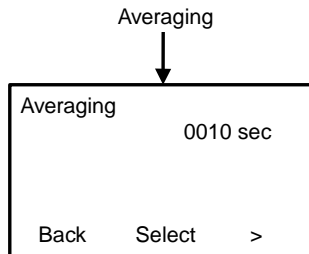

1. Select the digits one by one with the left/right keys and set the value with the up/down keys.
2. Press OK to save the final setting.

## Units

The "Units" option sets the unit for the flow rate. The available units are shown below.

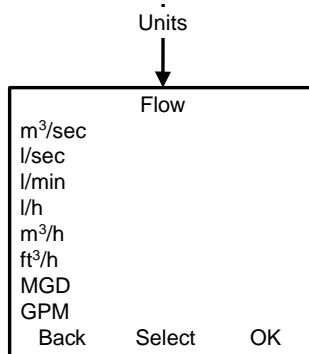

1. Press the up/down keys to highlight the required unit and then press OK to select it.

## mA Output

When a *MagFlux*® is connected to a power supply for the first time, the mA output is automatically set to provide 4 mA at zero flow and 20 mA at a flow corresponding to the theoretical  $Q_{max}$  of the flow sensor.

Changes in the mA setting will not affect the relay output settings.

Note: Both values can be set in the range 10 % to 120 %, making it possible to increase or decrease the mA signal.

The "mA Output" parameters can be configured in four different ways. Each option is described in the following sections.

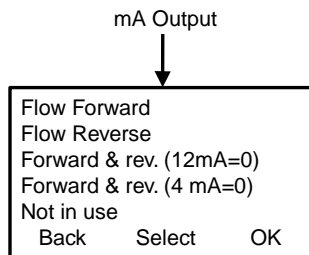

Using the factory setup **MagFlux®** returns to default mA settings corresponding to the chosen **MagFlux®** flow sensors  $Q_{min}$  and  $Q_{max}$ .

The mA output is an active output, and the maximum load is 800 Ohm.

The upper limit for the mA output is 20,5 mA

3,75 mA indicates the mA output is not in use

3,5 mA indicates flow under 4 mA level

20,5 mA indicates flow higher than 20 mA level.

The 20 mA maximum output is rounded up to the nearest round figure.

**Example: The maximum flow of 17.676 m<sup>3</sup>/h for a DN25 is rounded up to 20.000 m<sup>3</sup>/h.**

### Flow Forward

The mA signal provides 4 mA at zero flow and 20 mA at  $Q_{max}$  in the forward direction.

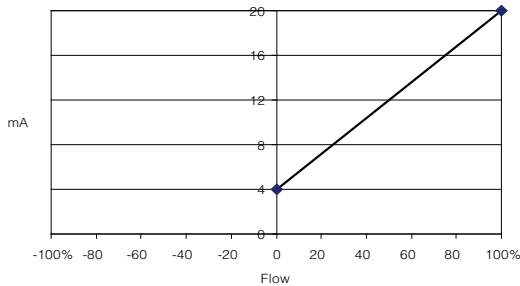
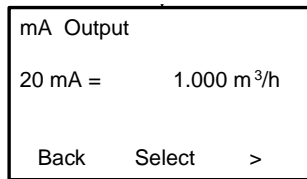



### Flow Reverse

The mA signal provides 4 mA at zero flow and 20 mA at  $Q_{max}$  in the reverse direction.

mA Output		
20 mA =	1.000 m <sup>3</sup> /h	
Back	Select	>

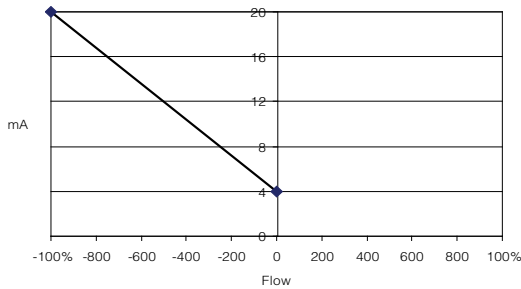

### Forward & Rev. (12mA=0)

The mA signal provides 4 to 20 mA reverse to forward direction with 12 mA at zero flow.

mA Output		
4 mA =	0,00 m <sup>3</sup> /h	
20 mA =	1.000 m <sup>3</sup> /h	
Back	Select	>

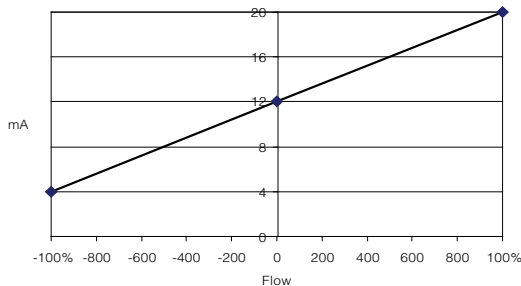

### Forward & rev. (4mA=0)

The mA signal provides 4 to 20 mA for forward and reverse flow with 4 mA at zero flow.

mA Output	
4 mA =	0,00 m <sup>3</sup> /h
20 mA =	1.000 m <sup>3</sup> /h
Back	Select >

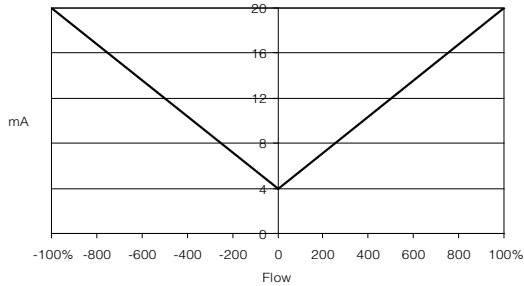

### Not in use

The "mA Output" option is not being used.

## Totalizers

The **MagFlux®** provides six totalizers, each with two or three output options. Up to two totalizers can be assigned to one digital output.

The totalizers are:

<b>RFTot</b>	<b>R</b> esettable <b>F</b> orward <b>T</b> otalizer
<b>RRTot</b>	<b>R</b> esettable <b>R</b> everse <b>T</b> otalizer
<b>RSTot</b>	<b>R</b> esettable <b>S</b> um <b>T</b> otalizer
and	
<b>NR FTot</b>	<b>N</b> on- <b>R</b> esettable <b>F</b> orward <b>T</b> otalizer
<b>NR RTot</b>	<b>N</b> on- <b>R</b> esettable <b>R</b> everse <b>T</b> otalizer
<b>NR Cnt</b>	<b>N</b> on- <b>R</b> esettable ( <b>C</b> ounter) <b>S</b> um Totalizer

The available output options for the **resettable totalizers** are:

- Mechanical Relay (DO2)**
- Opto Relay (DO1)** (light-triggered electronic relay)
- Display only** (on the Display Unit)

The available output option for the **non-resettable totalizers** is:

- Display only** (on the Display Unit)

If a chosen output is not available (dedicated to another function), a "Device Exception" pop-up message will inform the operator.

## Settings and Limits for Resettable Totalizers

### Totalizer Forward Unit

Available units are l, hl, kl, m<sup>3</sup>, ft<sup>3</sup>, gal and MG.

### Reset with Digital Input

Reset the totalizer via the digital input (DI)

### On-time

The pulse length of the opto digital output (DO 1) is adjustable from 1 ms to 10 secs.

The pulse length of the mechanical digital relay (DO 2) is adjustable from 100 ms to 10 secs.

### Volume between Pulses

Select a volume between pulses in steps of: 0,001, 0,01, 0,1, 1, 10, 100 and 1000.

MagFlux Totalizer Output Setting					
Metric					
	Optical DO 1 @100 mSec.		Mechanical DO 2 @100 mSec.		
DN [mm]	min.	max.	min.	max.	Unit
3	0,0001	0,1	0,01	0,1	m3
6	0,0001	1	0,01	1	m3
8	0,001	1	0,1	1	m3
10	0,001	1	0,1	1	m3
15	0,001	1	0,1	1	m3
20	0,001	1	0,1	1	m3
25	0,01	10	1	10	m3
32	0,01	10	1	10	m3
40	0,01	10	1	10	m3
50	0,01	10	1	10	m3
65	0,01	100	1	100	m3
80	0,1	100	10	100	m3
100	0,1	100	10	100	m3
125	0,1	100	10	100	m3
150	0,1	100	10	100	m3
200	0,1	1000	10	1000	m3
250	1	1000	100	1000	m3
300	1	1000	100	1000	m3
350	1	1000	100	1000	m3
400	1	1000	100	1000	m3
450	1	1000	100	1000	m3
500	1	1000	100	1000	m3
600	1	10000	100	10000	m3
700	1	10000	1000	10000	m3
800	10	10000	1000	10000	m3
900	10	10000	1000	10000	m3
1000	10	10000	1000	10000	m3
1200	10	10000	1000	10000	m3

If a required volume between pulses is not contained in the above steps, for example for a pre-set to a sampler, use the batch counter option.

The relays are limited to a minimum and a maximum of pulses per hour depending on the 20 mA scale and the on-time of the relay in milliseconds.

### DO 1 (Opto Relay)

The maximum limit is 500 pulses per second at 1 ms pulse length.

The formula for the minimum flow unit per pulses is:

$$\text{(flow at 20mA)} \times \text{(pulse delay in mSec)} / 1800000$$

**Example: Min. flow unit/pulses for DN 100 max. flow 300 m<sup>3</sup>/h ?**

*Minimum flow unit per pulses = 300 m<sup>3</sup> x 100 mSec / 1800000 = 0,016 m<sup>3</sup> which is rounded to 0,1 m<sup>3</sup> by the MagFlux.*

The formula for the maximum flow unit per pulses is:

$$\text{(flow at 20mA)}$$

**Example: DN 100 max. flow 300 m<sup>3</sup>/h ?**

*Maximum flow unit per pulses = 300 m<sup>3</sup>*

### DO 2 (Mechanical Relay)

The maximum limit is 120 pulses per hour.

The formula for minimum flow unit per pulses is:

$$\text{(flow at 20mA)} / 120$$

**Example: DN 100 max. flow 300 m<sup>3</sup>/h ?**

*Minimum flow unit per pulses = 300 / 120 = 2,5 m<sup>3</sup> which is rounded to 10 m<sup>3</sup> by the MagFlux.*

The formula for maximum flow unit per pulses is:

$$\text{(flow at 20mA)}$$

**Example: DN 100 max. flow 300 m<sup>3</sup>/h ?**

*Maximum flow unit per pulses = 300 m<sup>3</sup>*

## Resettable Totalizers

Totalizers can be reset from the Main display (see page 71) and via the digital input DI (see page 30).

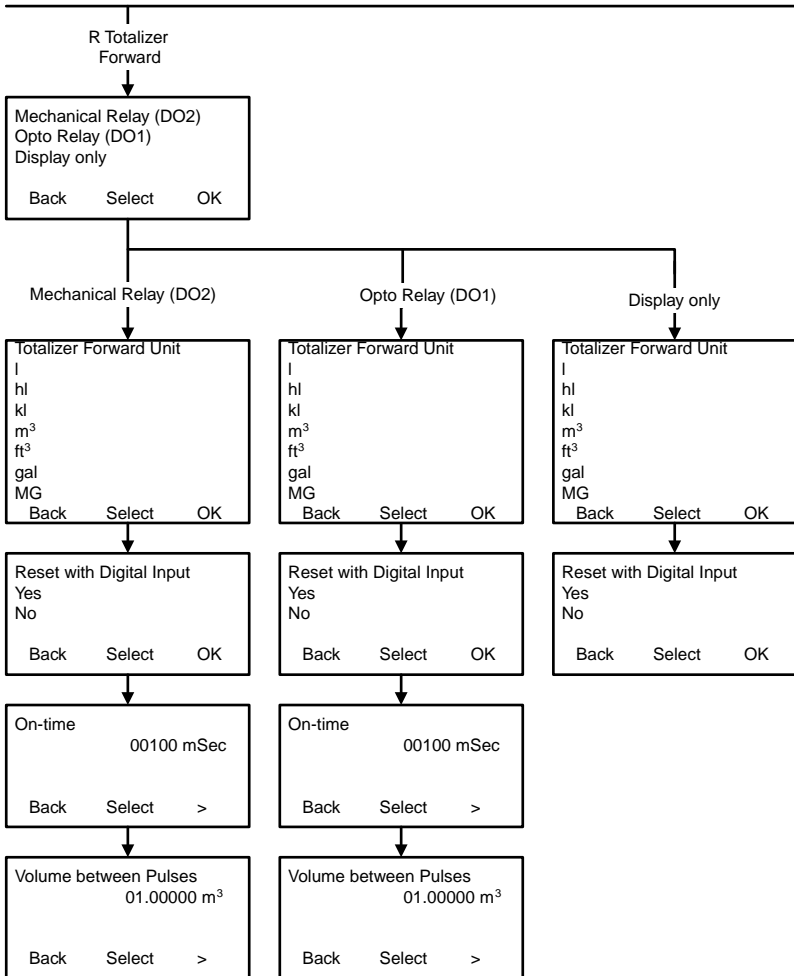

## **Resettable Forward Totalizer**

### **RFTot**

The Totalizer counts the forward flow volume according to the primary flow direction selected at startup.

The Totalizer counts in selected units and is resettable.

The counter can be connected to the relays or to the display only.

To reset the counter, the totalizer must be present in the Main display and be selected by the up/down keys followed by a click on Reset.

Alternatively it can be reset via the digital input DI.

## **Resettable Reverse Totalizer**

### **RRTot**

The Totalizer counts the reverse flow volume according to the primary flow direction selected at startup.

The Totalizer counts in selected units and is resettable.

The counter can be connected to the relays or to the display only.

To reset the counter, the totalizer must be present in the Main display and be selected by the up/down keys followed by a click on Reset.

Alternatively it can be reset via the digital input DI.

## **Resettable Sum Totalizer**

### **RSTot**

The Totalizer counts the sum of forward flow volume minus the reverse flow volume according to the primary flow direction selected at startup.

The Totalizer counts in selected units and is resettable.

The counter can be connected to the relays or to the display only.

To reset the counter, the totalizer must be present in the Main display and be selected by the up/down keys followed by a click on Reset.

Alternatively it can be reset via the digital input DI.

## Non-Resettable Totalizers

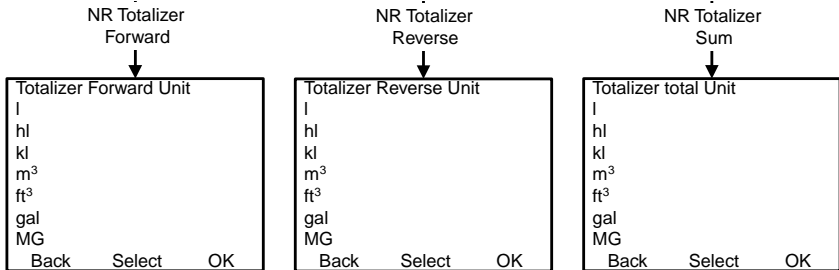

### NR Forward Totalizer

#### NR FTot

The Totalizer counts the forward flow volume according to the primary flow direction selected at start up.

The Totalizer counts in selected units and cannot be reset.

The counter can only be selected from the Main display.

### NR Reverse Totalizer

#### NR RTot

The Totalizer counts the reverse flow volume according to the primary flow direction selected at start up.

The Totalizer counts in selected units and cannot be reset.

The counter can only be selected from the Main display.

### NR Sum Totalizer

#### NR Cnt

The Totalizer counts the sum of forward flow volume minus the reverse flow volume according to the primary flow direction selected at startup.

The Totalizer counts in selected units and cannot be reset.

The counter can only be selected from the Main display.



## Batch Counters 1 & 2

The batch counters can operate in three different ways: automatically, manually or adaptively, and they deduct a reverse flow from the forward flow.

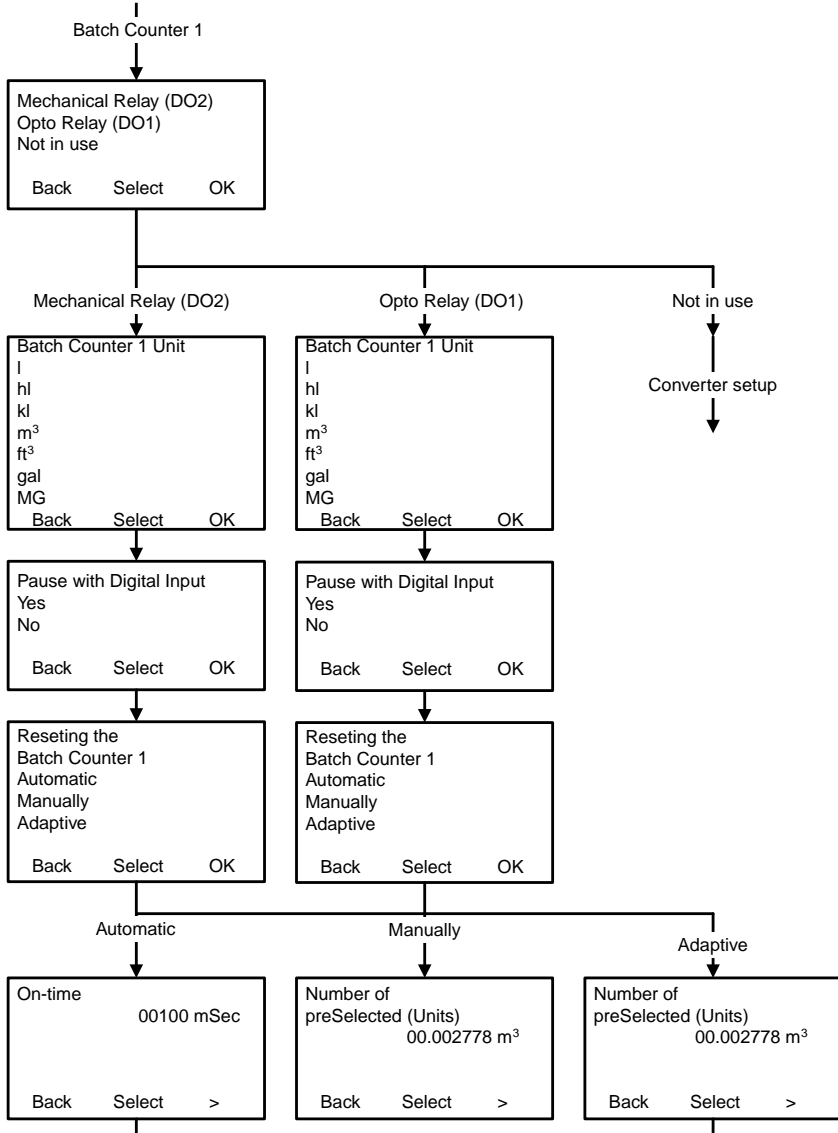

Batch Counter Option Chart (cont'd)

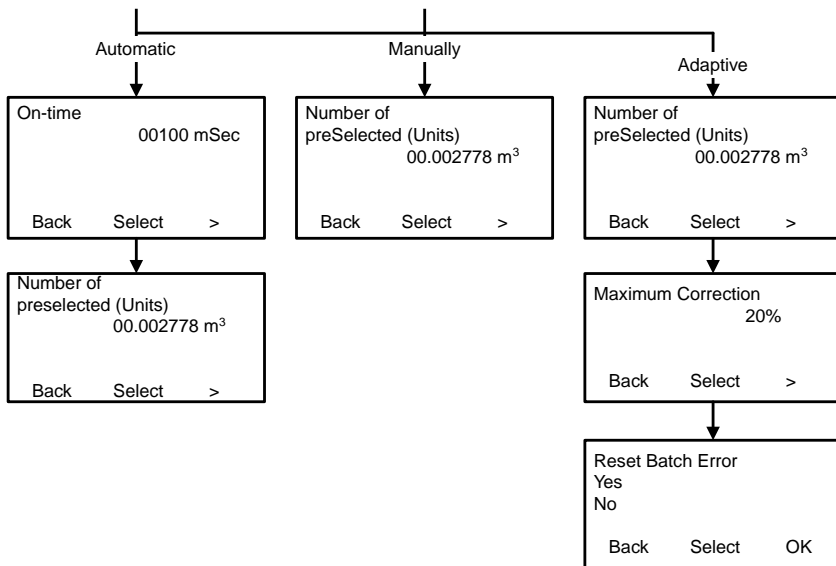

In the following descriptions of the batch counters, the function or digital status is illustrated as follows:

- Function or DO activated
- Function or DO deactivated

### Automatic Batch Counter

The automatic batch counter issues a signal, when a preset volume is reached.

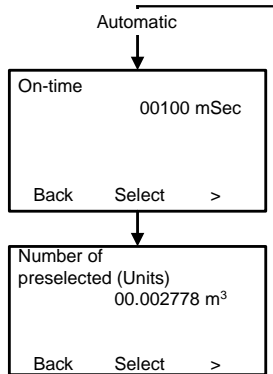

### On-time

The period of time in which the relay is activated (in on-state)

### Number of preselected (units)

The preset batch volume.

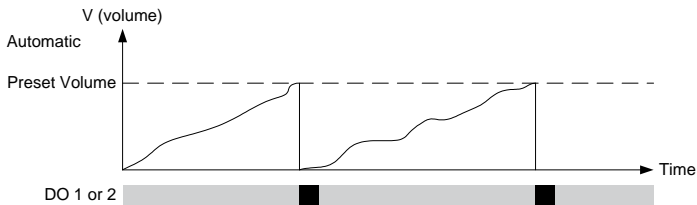

## Manual Batch Counter

The counter issues signals as determined by manual start, stop and pause commands. A manual stop is equivalent to a reset command.

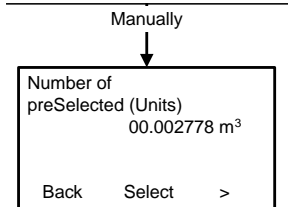

## Number of preSelected (Units)

The preset batch volume.

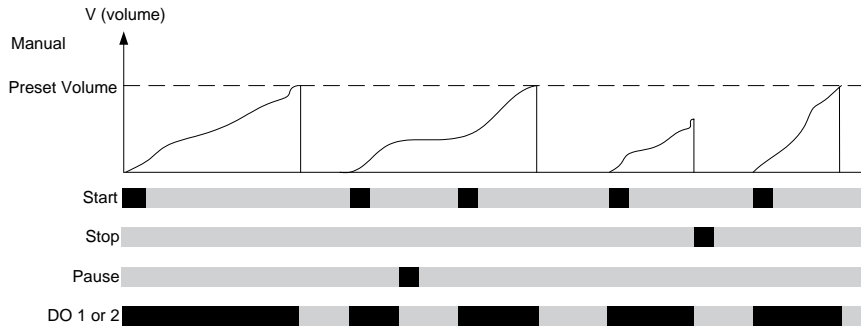

## Adaptive Batch Counter

The counter adapts compensates for overrun and insufficient flow.

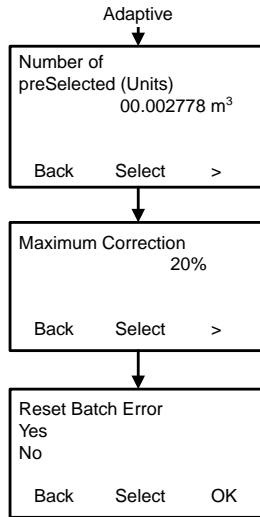

### Number of preSelected (Units)

The preset batch volume.

### Maximum Correction

The correction in percent that triggers an error message or an alarm.

### Reset Batch Error

Reset the batch correction percentage to 0%.

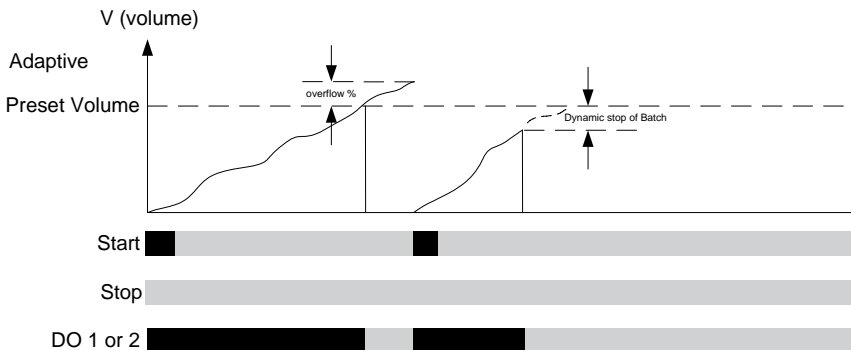

## **Settings and Limits for Batch Counters**

### **Batch counter units**

Available units are l, hl, kl, m<sup>3</sup>, ft<sup>3</sup>, gal and MG.

### **Start, stop or pause with Digital Input**

The manual and the adaptive batch counters can be started, stopped or paused via the digital input (DI)

### **On-time**

The pulse length of the opto digital output (DO 1) is adjustable from 1 ms to 10 secs.

The pulse length of the mechanical digital relay (DO 2) is adjustable from 100 ms to 10 secs.

### **Volume between pulses**

Select a volume between pulses as listed in the table overleaf.

The relays are limited to a minimum and a maximum of pulses pr. hour depending on the 20 mA scale and the on-time of the relay in milliseconds.

**MagFlux Batch Counter Output Settings**

Metric							
DN [mm]	Optical DO 1 @100 mSec.			Mechanical DO 2 @100 mSec.			Unit
	min.		max.	min.		max.	
	Automatic	Manually/ adaptive		Automatic	Manually/ adaptive		
3	0,0000139	0,0006944	0,25	0,0020833	0,0006944	0,25	m³
6	0,0000556	0,0027778	1	0,0083333	0,0027778	1	m³
8	0,0001111	0,0055556	2	0,0166667	0,0055556	2	m³
10	0,0002778	0,0138889	5	0,0416667	0,0138889	5	m³
15	0,0002778	0,0138889	5	0,0416667	0,0138889	5	m³
20	0,0005556	0,0277778	10	0,0833333	0,0277778	10	m³
25	0,0011111	0,0555556	20	0,1666667	0,0555556	20	m³
32	0,0016667	0,0833333	30	0,2500000	0,0833333	30	m³
40	0,0027778	0,1388889	50	0,4166667	0,1388889	50	m³
50	0,0041667	0,2083333	75	0,6250000	0,2083333	75	m³
65	0,0055556	0,2777778	100	0,8333333	0,2777778	100	m³
80	0,0111111	0,5555556	200	1,6666667	0,5555556	200	m³
100	0,0166667	0,8333333	300	2,5000000	0,8333333	300	m³
125	0,0222222	1,1111111	400	3,3333333	1,1111111	400	m³
150	0,0333333	1,6666667	600	5,0000000	1,6666667	600	m³
200	0,0555556	2,7777778	1000	8,3333333	2,7777778	1000	m³
250	0,1111111	5,5555556	2000	16,6666667	5,5555556	2000	m³
300	0,1388889	6,9444444	2500	20,8333333	6,9444444	2500	m³
350	0,1666667	8,3333333	3000	25,0000000	8,3333333	3000	m³
400	0,2500000	12,5000000	4500	37,5000000	12,5000000	4500	m³
450	0,3333333	16,6666667	6000	50,0000000	16,6666667	6000	m³
500	0,3888889	19,4444444	7000	58,3333333	19,4444444	7000	m³
600	0,5555556	27,7777778	10000	83,3333333	27,7777778	10000	m³
700	0,8333333	41,6666667	15000	125,0000000	41,6666667	15000	m³
800	1,1111111	55,5555556	20000	166,6666667	55,5555556	20000	m³
900	1,3888889	69,4444444	25000	208,3333333	69,4444444	25000	m³
1000	1,6666667	83,3333333	30000	250,0000000	83,3333333	30000	m³
1200	2,2222222	111,1111111	40000	333,3333333	111,1111111	40000	m³

### Limitation of the automatic batch counter on DO 1 (Opto Relay)

The maximum limit is 500 pulses pr sec at 1 ms pulse length.

The formula for the minimum flow unit pr pulses is:

$$\text{(flow at 20mA)} \times \text{(pulse delay in mSec)} / 1800000$$

**Example: Min. flow unit/pulses for DN 100 max. flow 300 m<sup>3</sup>/h ?**

Minimum flow unit pr pulses =  $300 \text{ m}^3 \times 100 \text{ mSec} / 1800000 = 0,016 \text{ m}^3$  which is rounded to  $0,1 \text{ m}^3$  by the MagFlux.

The formula for the maximum flow unit pr pulses is:

$$\text{(flow at 20mA)}$$

**Example: DN 100 max. flow 300 m<sup>3</sup>/h ?**

Maximum flow unit pr pulses =  $300 \text{ m}^3$

### Limitation of the automatic batch counter on DO 2 (mech. relay)

The maximum limit is 120 pulses pr hour.

The formula for minimum flow unit pr pulses is:

$$\text{(flow at 20mA)} / 120$$

**Example: DN 100 max. flow 300 m<sup>3</sup>/h ?**

Minimum flow unit pr pulses =  $300 / 120 = 2,5 \text{ m}^3$

The formula for maximum flow unit pr pulses is:

$$\text{(flow at 20mA)}$$

**Example: DN 100 max. flow 300 m<sup>3</sup>/h ?**

Maximum flow unit pr pulses =  $300 \text{ m}^3$

### Limitation of the manual and adaptive batch counter on DO 1 or DO 2

The formula for minimum flow unit pr pulses is:

$$\text{(flow at 20mA)} / 360$$

**Example: DN 100 max. flow 300 m<sup>3</sup>/h ?**

Minimum flow unit pr pulses =  $300 / 360 = 0,833 \text{ m}^3$



The formula for maximum flow unit pr pulses is:

**(flow at 20mA)**

**Example: DN 100 max. flow 300 m3/h ?**

Maximum flow unit pr pulses = 300 m<sup>3</sup>

### High Flow/Low Flow

The high and low flow options provide alarms and trigger relays when certain volume limits are exceeded or not reached.

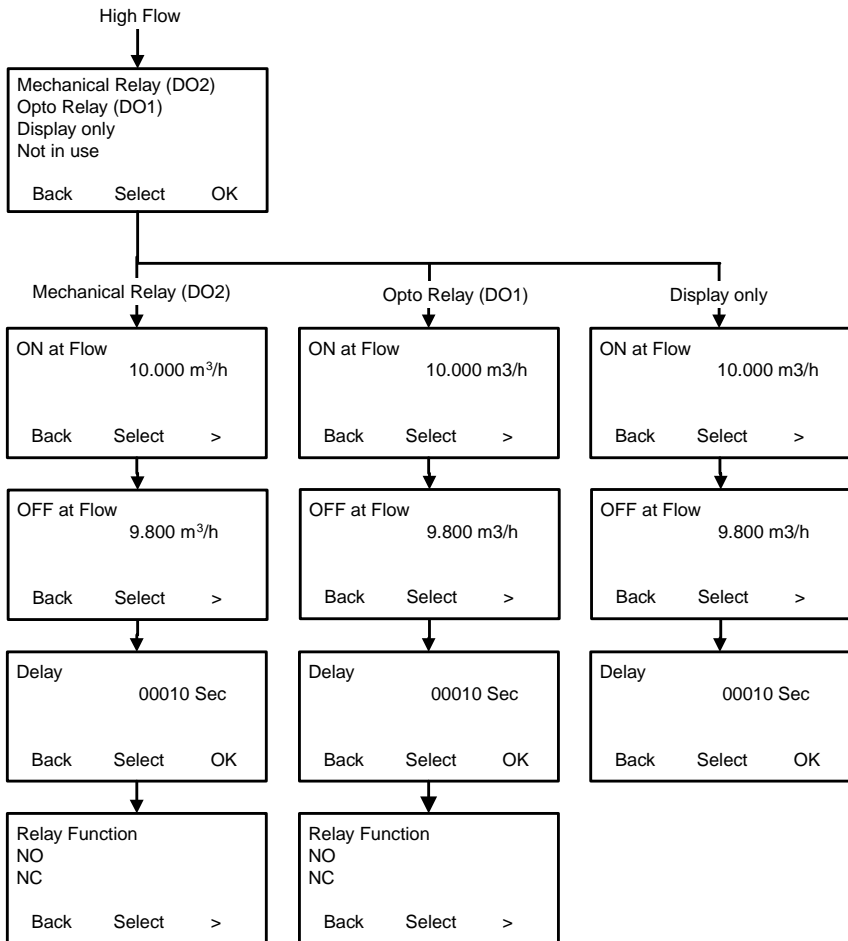

The available output options for High Flow and Low Flow are:

**Mechanical Relay (DO2)**

**Opto Relay (DO1)** (light-triggered, electronic relay)

**Display only** (signals to the Display Unit only)

**Not in use** (the High/Low Flow option is not being used)

**On at Flow**

Issues an alarm and/or sends a signal when for example a high flow limit is exceeded.

**OFF at Flow**

Cancels an alarm and/or sends a signal when recovering from for example an overflow situation.

**Delay**

A delay in seconds can be set to compensate for positive and negative spikes in the flow. The length is the time between an incident and setting an alarm.

**Relay Function**

**NO** (Normally Open) determines the relay state under normal conditions.

**NC** (Normally Closed) determines the relay state under normal conditions.

## Flow Direction

The "Flow Direction" option indicates the flow direction of the flow and determines the open/closed state of the relay.

The default Flow Direction is set to "Direction A". If flow "Direction A" and the "NO" function are chosen, the relay is on at a negative flow ("Direction B").

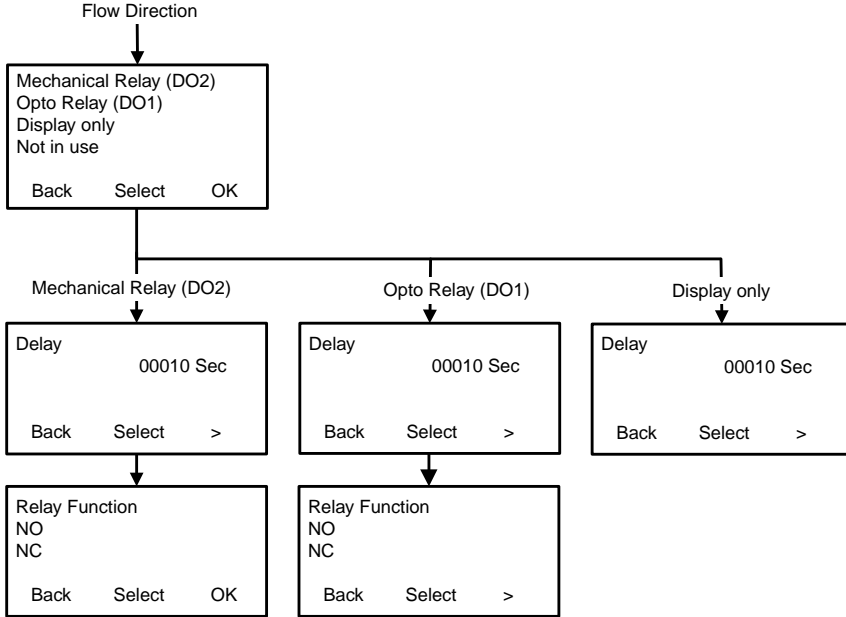

The available output options for "Flow Direction" are:

**Mechanical Relay (DO2)**

**Opto Relay (DO1)** (light-triggered electronic relay)

**Display only** (signals to the Display Unit only)

**Not in use** (the Flow Direction option is not being used)

**Delay**

A delay in seconds can be set to compensate for positive and negative spikes in the flow. The length is the time between an incident and setting an alarm.

**Relay Function**

**NO** (Normally Open) determines the relay state under normal conditions.

**NC** (Normally Closed) determines the relay state under normal conditions.

## Empty Pipe

A signal and/or an alarm can be set, when the sensor becomes practically empty (see also pages 19 - 22 incl.), or if the conductivity drops below 5 µS/cm.

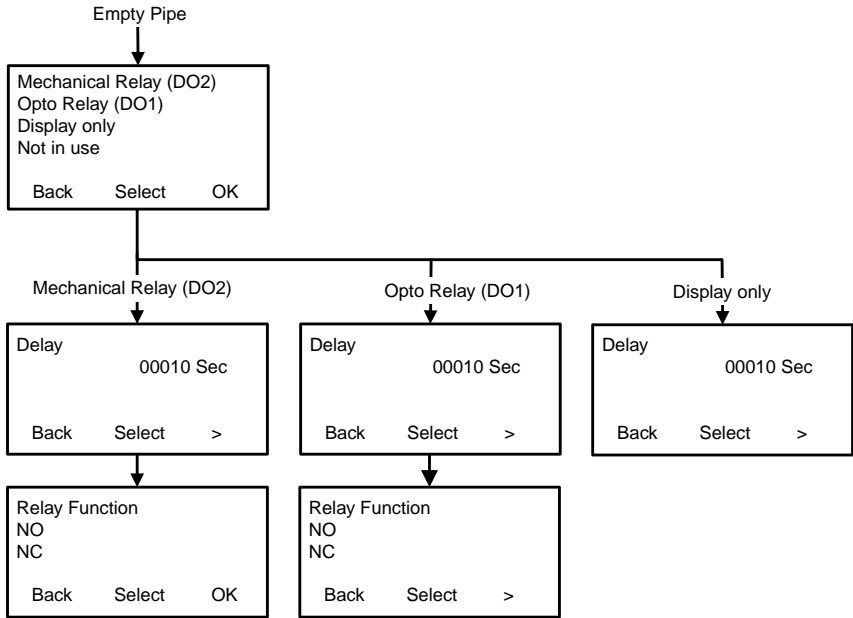

The available output options for "Empty Pipe" are:

**Mechanical Relay (DO2)**

**Opto Relay (DO1)** (light-triggered electronic relay)

**Display only** (signals to the Display Unit only)

**Not in use** (the Empty Pipe option is not being used)

### Delay

A delay in seconds can be set to compensate for positive and negative spikes in the flow. The length is the time between an incident and setting an alarm.

### Relay Function

**NO** (Normally Open) determines the relay state under normal conditions.

**NC** (Normally Closed) determines the relay state under normal conditions.

## 24h Flow

The "24h Flow" option measures the total flow (FTot) for 1 day (24 hours) and logs at midnight (12 PM). Contact MJK for detailed information. Valid settings are "No" and "Yes" (default is "No").

## Status

The "Status" option provides an overview of the in- and output status. The check boxes can contain four different characters to indicate the current status at that very moment:

- X** A cross (X) in a check box indicates an active state
- /** A blinking forward slant (/) in a check box indicates that the input/output is in the process of being activated. Eventually it turns into a steady X.
- \** A blinking backward slant (\) in a check box indicates that the input/output is in the process of being de-activated. Eventually the check box is cleared.

An empty check box indicates a de-activated state.

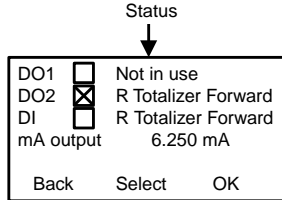

### DO1 Not in use

Digital output DO1 is active (an empty check box).

### DO2 X Totalizer Forward

Digital output DO2 for Totalizer Forward is activated (a ticked check box).

### DI Totalizer Forward

Digital input DI for Totalizer Forward is active (an empty check box)

### mA output 6.250 mA

The present analog output current is 6.250 mA.

## Service Menu

The "Service Menu" provides options intended for service personnel during installation, calibration, operation, monitoring and maintenance.

All parameters can be read without any restrictions, but certain parameters can only be changed after a password has been typed.

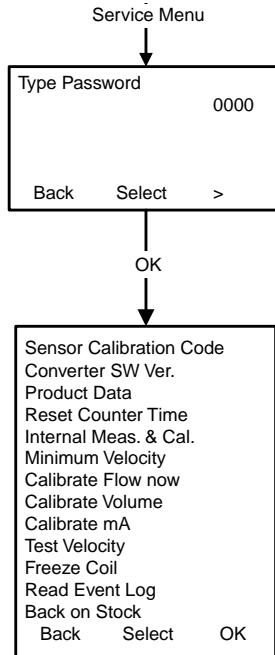

## Sensor Calibration Code

Each and every **MagFlux®** has a unique calibration code that contains calibration data for the specific unit. A calibration code could for example be dw5uq4 or 7v3ri0.

The current converter firmware requires an 8-character input, but it also accepts 6 characters plus two "Ok"s. If the code is dw5uq4, enter:

**d w 5 u q 4 "Ok" "Ok"**

where "Ok" indicates that you press the "Ok" key without selecting any character. Only small letters can be entered from the **MagFlux®** keypad.

**IMPORTANT:** All letters are **small** letters (e.g. “a” and not “A”), and numbers are **big** characters (e.g. “0”, zero and not “o”, small o).

A potential source of error is incorrect reading of numbers and letters, where a small “o” is confused with a zero (“0”), or a small “l” is confused with the number one (“1”).

Note also that the default flow direction from factory is “A”.

See page 14 regarding the calibration code.

A password is not required to add or change the sensor calibration code.

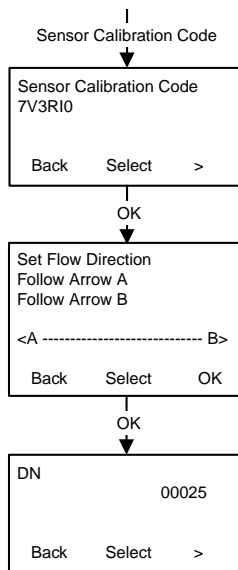

### Converter SW Ver.

The converter software version and bootload version are displayed, so that you can determine whether a software (firmware) upgrade is required or not.

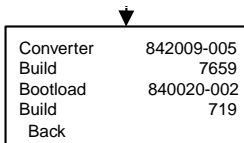

### Product Data

Key product data like ID, hardware type no., track no., etc. are displayed.

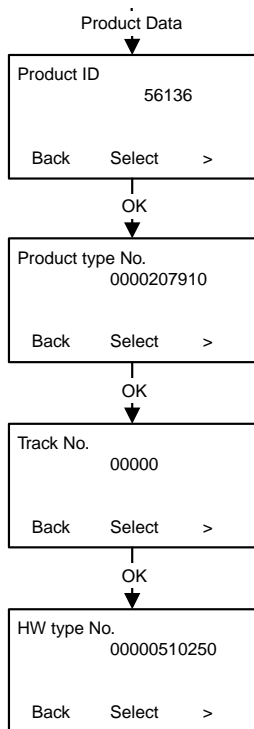



### Reset Counter Time

The counter reset and runtime can be reset for fault finding, error correction and similar service procedures.

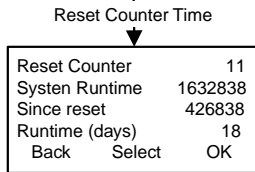

### Internal Meas. & Cal.

Internal measurements and calculations are for service technician use only, and are used for adjustments and calibrations.

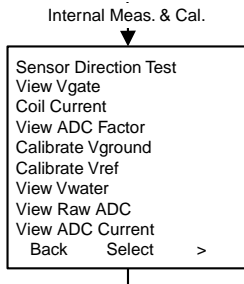

### Minimum Velocity

The incoming data is below the measuring accuracy. The option forces the minimum velocity to zero.

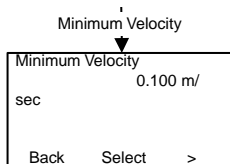

### Calibrate Flow Now

First "View Flow Now" is displayed, and then afterwards you can calibrate the flow.

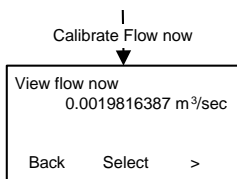

### Calibration volume

The volume counter can be reset and a new value can be entered.

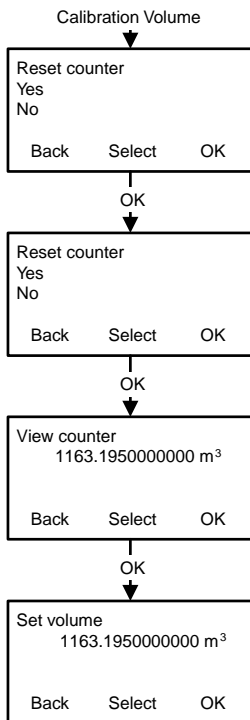

### Calibrate mA

From this menu the mA reading can be calibrated against a multimeter.

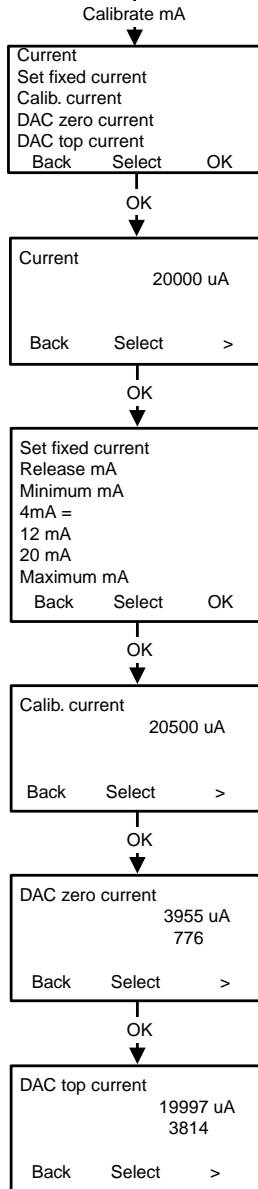

## Test Velocity

Test velocity is for are for service technician use only and can be used to compare the actual velocity against the flow/velocity/diameter chart.

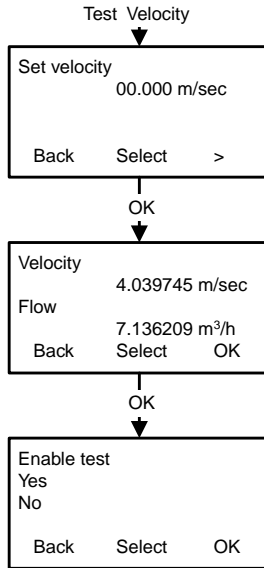

### Freeze Coil

For service technician use only. The sensor coil current and voltage values can be "frozen" to enable read-out using an standard multimeter.

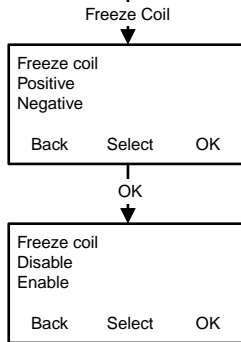

### Read Eventlog

See the events within a certain time frame.

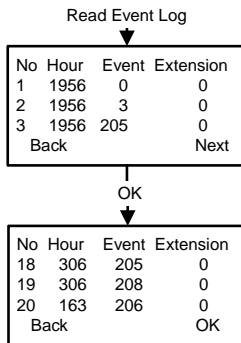

### Read sensor data

Access the sensor's key data.

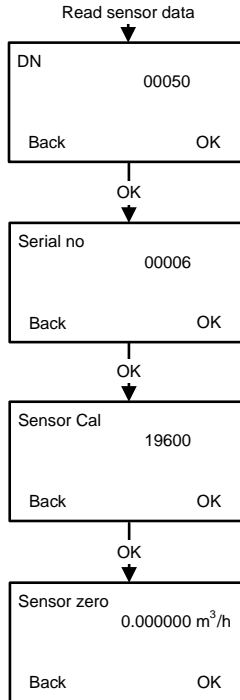

### Back on Stock

The factory settings can be re-established. with the "Back On Stock" option.

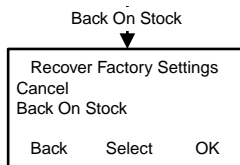

## Display Setup

The "Display Setup" menu provides configuration options for language, clock and factory settings, Modbus parameters and software version display.

1. Press the up/down keys to highlight the required menu line (here: Display Setup) and then press OK to select it.

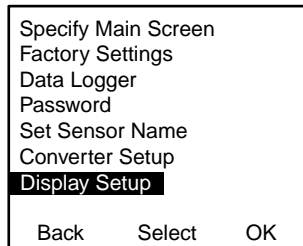

2. Press the up/down keys to highlight the required option and then press OK.

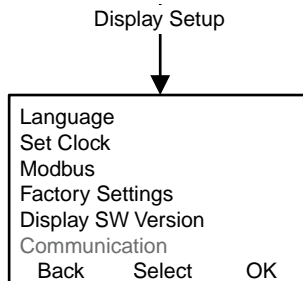

The available options are described in detail on the following pages.

Note: The option "Communication" is only visible (and selectable), if a communication module is installed and connected to the MagFlux display. If the communication module is removed, the option disappears automatically.

A description of available communication settings can be found in the manual for communication modules "Communication Moduler for Displays".

## Language

The **MagFlux®** is installed with a language package, and GB English is the default language.

In the "Language" menu several national languages can be selected.



Additional languages can be added using the MJK-Field Link software program (see also Appendix B on page **115**).

1. Chose the required language using the up/down keys up and then press OK.



## Set Clock

The "Set Clock" menu provides setting of the built-in clock and the time format.

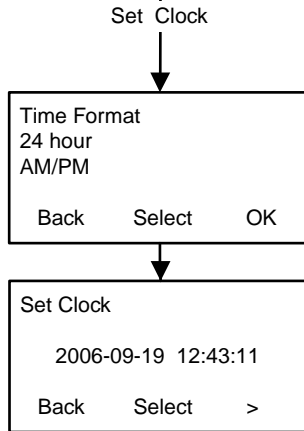

1. Select the date and time digits with the left/right keys and change the setting with the up/down keys.
2. Press OK and repeat step 1 for all remaining digits.
3. Press OK to save the time/clock settings.

## Modbus

The **MagFlux®** is delivered with a standard Modbus RTU protocol, and up to four **MagFlux®** converters can be connected for concurrent operation.

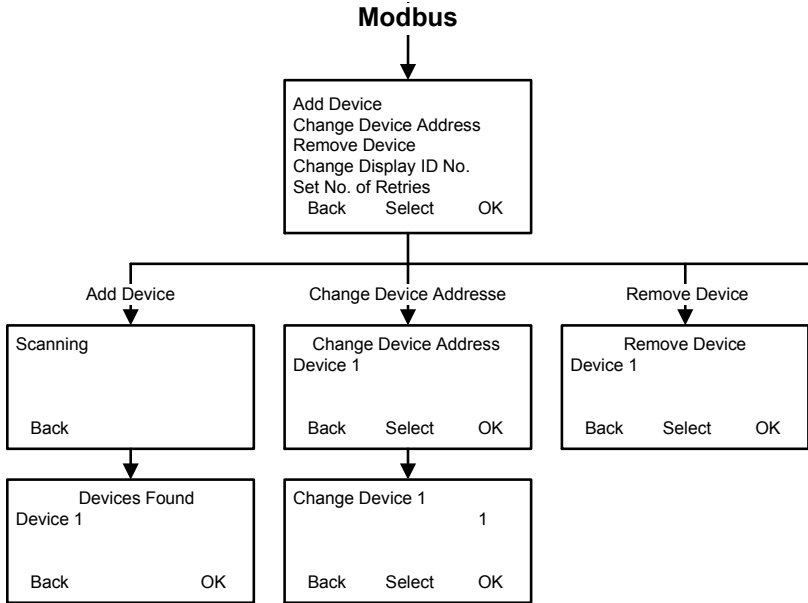

When several converters are to be added, it is necessary to change each converter device address to a unique ID address before connecting the converter to the Display Unit.

### Add Device

Four **MagFlux®** Converters can be connected to one Display Unit using the RS485 interface connection. Note that only one Display Unit can be used with several converters.

The Display Unit can easily be moved to another converters for readout and configuration.

1. Select "Add Device", click OK and wait for the scan process to finish.
2. The found converters are finally displayed.

### Change Device Address

To change each converter's device address it is required that you connect

the Display Unit to each converter one by one. If neglected, a conflict between the units will arise when the RS 485 serial loop is established.

Change for example "Device 1" to "Device 2" as follows:

1. Press OK and use the up/down keys to change "1" to "2".
2. Press OK.

The **MagFlux®** converter ID is now changed to "2", and more converters can be added to the Display Unit with the "Add Device" option.

### Remove Device

If a device is to be removed from the Display Unit, proceed as follows:

1. Select the required device with the up/down keys.
2. Click OK to remove it.

The device is now removed from the Display unit and display returns to the "Modbus" menu.

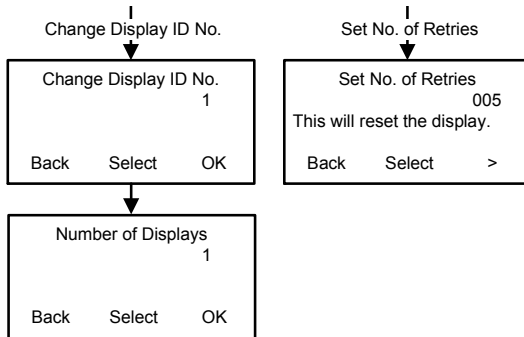

### Change Display ID No.

The display ID number and the number of displays may have to be changed to avoid conflicts on the Modbus.

### Set No. of Retries

If the data communication lines are subject to noise or other disturbances, the number of retries can be raised to increase the chances of a successful change of settings.

## Factory Settings

The "Factory Settings" menu provides log deletion and resetting to factory settings of the display unit.

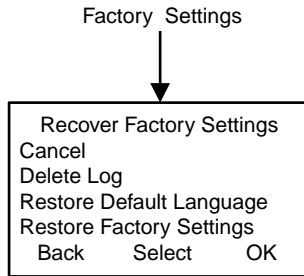

1. Press the up/down keys to highlight the required option and press OK.

### Important:

The Data Logger will be reset, and all devices will be deleted from the display Unit. This is indicated by the MJK start-up screen which is displayed within a few seconds.

## Display SW Version

The "Display SW Version" menu provides a read-out of the display software (actually firmware) version, the build date and last-edited date of the the multiple languages file.

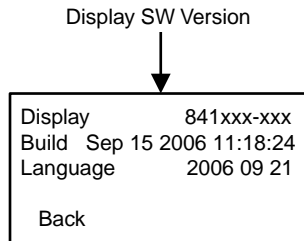

## 8. Mechanical Dimensions

### Standard Flanges - EN-1092-1:2001 - Europe

Flange marking: **zzz/EN 1092-1/01 A/DN xxxx/PN ww/S235JR/yyyy**

where:

zzz = Manufacturer's name/trademark  
 EN 1092-1 = Standard number  
 01 A = Flange type  
 DN xxxx = DN (size)  
 PN ww = PN (pressure)  
 S235JR = Material symbol/no/grade  
 yyyy = Traceable ID or control no.

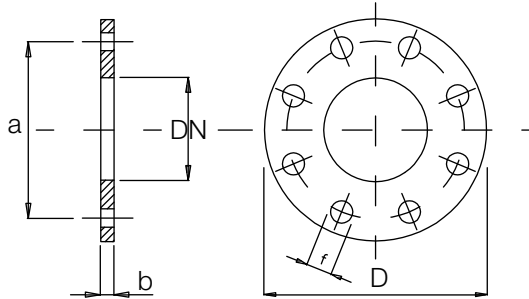

Flange Dimensions - EN-1092-1:2001

Size	Pressure	D	a	b				No. of holes	f	Bolt size	Flange type
				Thickness [mm]							
DN	PN	Outer diameter	Bolt diameter	PN 6	PN 10	PN 16	PN 40	Hole diameter			
[mm]	[bar]	[mm]	[mm]					[mm]			
15	40	95	65				14	4	14	M12	01
20	40	105	75				16	4	14	M12	01
25	40	115	85				16	4	14	M12	01
32	40	140	100				18	4	18	M16	01
40	40	150	110				18	4	18	M16	01
50	16	165	125			19		4	18	M16	01
65	16	185	145			20		8	18	M16	01
80	16	200	160			20		8	18	M16	01
100	16	220	180			22		8	18	M16	01
125	16	250	210			22		8	18	M16	01
150	16	285	240			24		8	22	M20	01
200	16	340	295			26		12	22	M20	01
250	10	395	350		26			12	22	M20	01
300	10	445	400		26			12	22	M20	01
350	10	505	460		28			16	22	M20	01
400	10	565	515		32			16	26	M24	01
450	10	615	565		36			20	26	M24	01
500	10	670	620		38			20	26	M24	01
600	10	780	725		42			20	30	M27	01
700	10	895	840		38			24	30	M27	05
800	6	975	920	44				24	30	M27	05
900	6	1075	1020	48				24	30	M27	05
1000	6	1175	1120	52				28	30	M27	05
1200	6	1405	1340	60				32	33	M30	05

### Standard Flanges - ANSI B 16.5 - U.S.A.

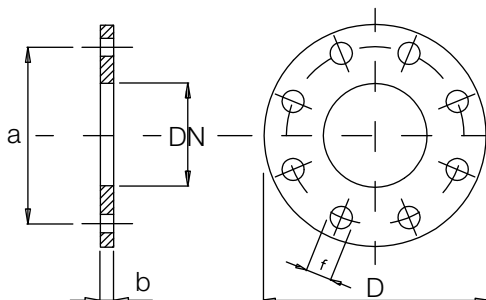

Flange Dimensions - ANSI B 16.5

Size	Pressure Class	D	a	b	No. of holes	f
		Outer diameter	Bolt diameter	Thickness [in]		Hole diameter
[in]	[psi] ①	[in]	[in]	150 lbs		[in]
1/2"	150	3.5	2.38	0.44	4	0.62
3/4"	150	3.9	2.75	0.50	4	0.62
1"	150	4.3	3.12	0.56	4	0.62
1 1/4"	150	4.6	3.50	0.62	4	0.62
1 1/2"	150	5.0	3.88	0.69	4	0.62
2"	150	6.0	4.75	0.75	4	0.75
2 1/2"	150	7.0	5.50	0.88	4	0.75
3"	150	7.5	6.00	0.94	4	0.75
4"	150	9.0	7.50	0.94	8	0.75
5"	150	10.0	8.50	0.94	8	0.88
6"	150	11.0	9.50	1.00	8	0.88
8"	150	13.5	11.75	1.12	8	0.88
10"	150	16.0	14.25	1.19	12	1.00
12"	150	19.0	17.00	1.25	12	1.00
14"	150	21.0	18.75	1.38	14	1.12
16"	150	23.5	21.75	1.44	16	1.12
18"	150	25.0	22.75	1.56	16	1.25
20"	150	27.5	25.00	1.69	20	1.25
24"	150	32.0	29.50	1.88	20	1,38
28"	150	36.5				
32"	150	41.4				
36"	150	46.0				
40"	150	50.2				
48"	150	59.4				

① 300-600-900 psi: Consult the factory.

Standard Flanges - AS-4087-2004 - Australia

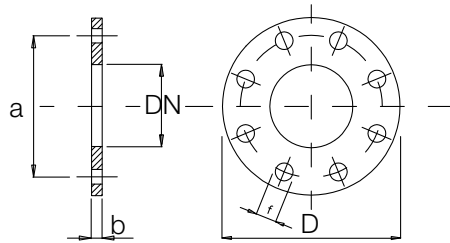

Flange Dimensions - PN 16 - AS-4087-2004					
Size	D	a	b		f
DN	Outer diameter	Bolt diameter	Thickness	No. of holes	Hole diameter
[mm]	[mm]	[mm]	[mm]		[mm]
15	95	67	6	4	14
20	100	73	6	4	14
25	115	83	8	4	14
32	120	87	8	4	14
40	135	98	10	4	14
50	150	114	10	4	18
65	165	127	11	4	18
80	185	146	11	4	18
100	215	178	13	4	18
150	280	235	19	8	18
200	335	292	19	8	18
250	405	356	23	8	22
300	455	406	30	12	22
350	525	470	30	12	26
400	580	521	30	12	26
450	640	584	30	12	26
500	705	641	38	16	26
600	825	756	48	16	30
700	910	845	56	20	30
800	1060	984	56	20	36
900	1175	1092	66	24	36
1000	1255	1175	66	24	36
1200	1490	1410	76	32	36

Standard Flanges - AS-4087-2004 (cont'd)

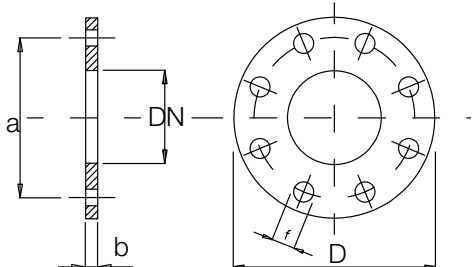

Flange dimensions - PN21 - AS 4087-2004					
Size	D	a	b		f
DN	Outer diameter	Bolt diameter	Thickness	No. of holes	Hole diameter
[mm]	[mm]	[mm]	[mm]		[mm]
15	95	67	10	4	14
20	100	73	10	4	14
25	120	87	10	4	18
32	135	98	13	4	18
40	140	105	13	4	18
50	165	127	15	4	18
65	185	146	15	8	18
80	205	165	15	8	18
100	230	191	19	8	18
150	305	260	24	12	22
200	370	324	24	12	22
250	430	381	30	12	26
300	490	438	30	16	26
350	550	495	38	16	30
400	610	552	38	20	30
450	675	610	38	20	33
500	735	673	48	24	33
600	850	781	58	24	36
700	935	857	58	24	36
800	1060	984	68	28	36
900	1185	1105	68	32	39
1000	1275	1194	78	36	39
1200	1530	1441	88	40	42



Standard Flanges - AS-4087-2004 (cont'd)

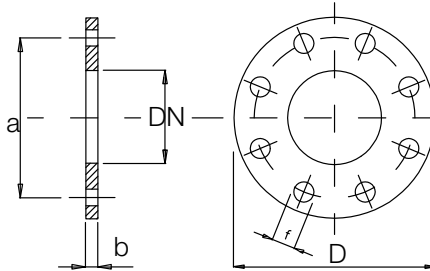

Flange dimensions - PN35 - AS-4087-2004

Size	D	a	b		f
DN	Outer diameter	Bolt diameter	Thickness	No. of holes	Hole diameter
[mm]	[mm]	[mm]	[mm]		[mm]
15	115	83	13	4	18
20	115	83	13	4	18
25	120	87	14	4	18
32	135	98	17	4	18
40	140	105	17	4	18
50	165	127	19	4	18
65	185	146	19	8	18
80	205	165	24	8	18
100	230	191	24	8	18
150	305	260	31	12	22
200	370	324	31	12	22
250	430	381	38	12	26
300	490	438	38	16	26
350	550	495	48	16	30
400	610	552	48	20	30
450	675	610	58	20	33
500	735	673	58	24	33
600	850	781	68	24	36
700	935	857	78	24	36
800	1060	984	84	28	36
900	1185	1105	94	32	39
1000	1275	1194	98	36	39
1200	1530	1441	108	40	42

This page intentionally left blank.

## Appendix A. Pop-up and Error Messages

Alarms	
Sensor Error	<b>Alarm</b> - The converter has experienced HW problems measuring flow (see log for details/time)
Sensor cal. Code error	<b>Alarm</b> - The calibration code conflicts with the sensor HW.
Output Coil Error	<b>Alarm</b> - The converter has experienced problems with connection to the sensor coil (see log for details/time)
Empty pipe	<b>Alarm</b> - The converter has detected no water in the sensor
Input over range	<b>Alarm</b> - Sensor flow can not be measured correct. Input is over max. level. Will normally only occur starting from zero flow to high flow. Will be present for max. 12 minutes.
Factory reset has occurred	<b>Alarm</b> - A factory reset has occurred (some settings have changed, check all used settings)
Eeprom write error	<b>Alarm</b> - Eeprom write error (see log for details)
Flow total counter eeprom error	<b>Alarm</b> - Flow totalize Eeprom error (non- resettable counter maybe incorrect in Eeprom)
Sensor Setting error	<b>Alarm</b> - Sensor Setting error (some settings are incorrect or changed)
Counter output Forward Pulsover-flow	<b>Alarm</b> - Counter output Forward Pulse overflow (too low pulse volume)

Counter output Reverse Pulsover-flow	<b>Alarm</b> - Counter output Reverse Pulse overflow (too low pulse volume)
Batch counter Pulsoverflow 1	<b>Alarm</b> - Batch1 counter overflow (the counter has restarted form zero)
Batch counter Pulsoverflow 2	<b>Alarm</b> - Batch2 counter overflow (the counter has restarted form zero)
Flow totalizer overflow	<b>Alarm</b> - Flow totalize overflow (non-resettable counter maybe incorrect in Eeprom)
mA Error	<b>Alarm</b> - Current out not connected (If the current out is used, deactivate Current out to stop this pop up)
mA flow Error	<b>Alarm</b> - Flow is over or under settings for current (it can be that flow is to high or negative)
Batch1 Adaptive Error	<b>Alarm</b> - Batch 1 adaptive flow is over/under the limit for error correction
Batch2 Adaptive Error	<b>Alarm</b> - Batch 2 adaptive flow is over/under the limit for error correction
Low flow	<b>Alarm</b> - Low flow is detected.
High flow	<b>Alarm</b> - High flow is detected

<b>Events</b>	
Sensor Auto Cal.	Event - Hold of flow output value because of auto calibration in converter (Normal)
Batch1 Ended	Event - Batch 1 has finished
Batch2 Ended	Event - Batch 2 has finished
System reset has occurred	Event - The converter has experienced a software or hardware reset (normal if the sensor number has been changed)
<b>Exceptions</b>	
Illegal function	Modbus function is not supported
Illegal address	The address is not valid
Illegal format	Data has an illegal format
Illegal data value	Data has a non-valid value
Missing user login	User password required to access
Missing MJK login	MJK password required to access
Relay used for pulse counter positive	The relay is already in use by another function. Select a different relay.
Relay used for pulse counter negative	The relay is already in use by another function.
Used for Resettable totalizer total	The relay is already in use by another function.
Used for batch counter 1	The relay is already in use by another function.
Used for batch counter 2	The relay is already in use by another function.
Used for low flow	The relay is already in use by another function.

Used for high flow	The relay is already in use by another function.
Used for flow direction	The relay is already in use by another function.
Used for empty pipe	The relay is already in use by another function.
Used for system error	The relay is already in use by another function.
<b>USB</b>	
Flash programming please wait	Programming is in progress but not finished.
Flash programming done	Programming is finished.
Flash crc error	Cyclic redundancy check error.
Unknown command flash user text	Invalid command issued.
Flash address overrun	A write error has occurred.
File phase error	Internal USB error.
File write failure	A write error has occurred.
USB protocol overrun	A communication error has occurred.

## Appendix B. MJK-Field Link Software

The MJK-Field Link software package provides several utilities that is described in detail in the manual regarding Field Link.

1. Current **MagFlux**® log data must be saved in a file before transferring and installing new firmware.
2. Note down all display and converter settings before upgrading new firmware.

### System Requirements Field Link

- Microsoft Windows XP sp2/ Vista /Win 7, 32bit
- Updated Java package
- USB 2.0 connection, Use with USB cable 691095

### Download Field Link™

Download Field Link at

MJK download Center>Accessories>Instrument Software

Or [www.mjk.com/downloads/downloads-products/downloads-accessories/downloads-instrument-software/](http://www.mjk.com/downloads/downloads-products/downloads-accessories/downloads-instrument-software/)

### Connect a PC to the Flow Meter

Download the 840110-051\_MJK\_Field\_Link\_Win\_XP\_7.zip file from the Download center, save it on your PC and unzip. The version number (051) may change.

The Un-zipped folder contains the file MJK-Field-Link 840110-051.EXE and the manual regarding the software.

Execute MJK-Field-Link 840110-051.EXE.



2. Unscrew the four screws that hold the Display Unit.
3. Lift out the Display Unit and connect a USB mini A/B cable to the mini USB female B connector on the rear of the front panel.
4. Connect the other end of the USB cable (max. 4.7 metres long) to the PC.
5. Select "File" in the menu bar and click "Connect".  
If the connection is successful, a "Device Clock" window for PC and device time synchronisation is displayed (if PC and device clock were out of sync.) along with a link status display (see below).

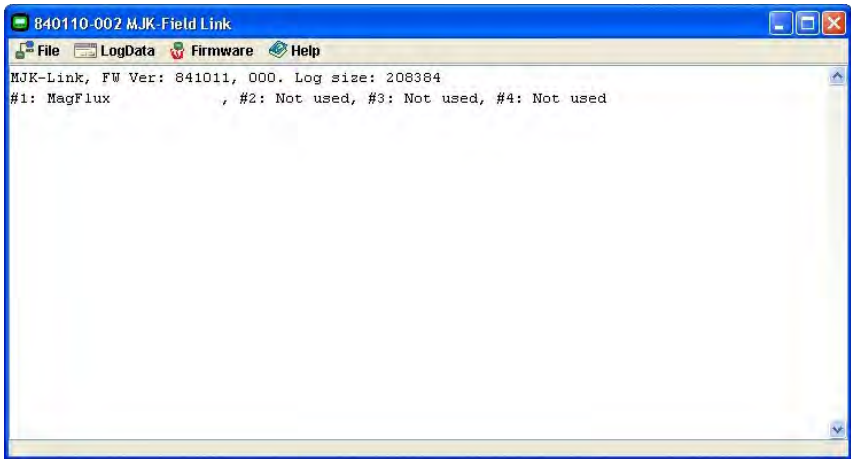

If the connection fails, first remove the cable and then re-connect it.

For further details, read the manual regarding MJK Field Link:

[www.mjk.com/downloads/downloads-products/downloads-accessories/downloads-instrument-software/](http://www.mjk.com/downloads/downloads-products/downloads-accessories/downloads-instrument-software/)



This page intentionally left blank.

This page intentionally left blank.

## Appendix C. FAQs - Frequently Asked Questions

\*\*\*\*\*

**Question:**

Which size flow meter should I choose for my installation? I would prefer a flow meter with the same diameter as the tube(s).

**Answer:**

The minimum and the maximum flows determine the size. Use the size chart (on page 18) to find the correct flow meter size, and avoid tending to select a too large size.

\*\*\*\*\*

**Question:**

Where do I install the flow meter in relation to valves, bends, pumps, etc.?

**Answer:**

Minimum 3 times the flow meter's internal diameter (DN) up-stream, and minimum 2 times the flow meter's internal diameter (DN) down-stream.

\*\*\*\*\*

**Question:**

Must the tube be completely filled with liquid to perform reliable flow measurements?

**Answer:**

Yes. Always ensure a filled tube.

\*\*\*\*\*

**Question:**

Do I need a separate display unit for each sensor?

**Answer:**

No. A display unit can manage up to four converters.

\*\*\*\*\*

**Question:**

Is the analogue mA output an active output?

**Answer:**

Yes, it is.

\*\*\*\*\*

\*\*\*\*\*

**Question:**

**The tubes are made of plastic. Do I need grounding rings?**

**Answer:**

It is a very good question, but there isn't a straight forward answer. It depends on the sensor type, the size and several other parameters. The issue is that the liquid and the sensor must have the same voltage potential.

MJK flow meters with  $DN \leq 50$  must always be equipped with grounding rings. MJK flow meters with  $DN > 50$  have a built-in ground electrode that makes grounding rings superfluous.

Coated metal tubes always require grounding rings.

If the conductivity is less than  $100 \mu\text{S}/\text{cm}$ , grounding rings are recommended.

When in doubt, always contact your local MJK representative or the MJK hot lines and describe your installation.

\*\*\*\*\*

**Question:**

**Are the relays potential-free?**

**Answer:**

Yes, they are.

\*\*\*\*\*

**Question:**

**Does the sensor/flow meter comply with IP68?**

**Answer:**

It will once you employ a wall mounting kit, a special cable and a gel potting kit to protect the electrical connections.

\*\*\*\*\*

**Question:**

**Can I use a MagFlux flow meter to measure non-conductive liquids such as diesel oil?**

**Answer:**

No. The electromagnetic principle presupposes conductivity. The conductivity limit is  $5 \mu\text{S}/\text{cm}$ .

\*\*\*\*\*

\*\*\*\*\*

**Question:**

**I have an "Empty pipe" indication, but the pipe is not empty!**

**Answer:**

There aren't any grounding rings, or the rings have not been properly grounded. See examples on page 23.

\*\*\*\*\*

**Question:**

**I can't set the counter to the required output, only to a value that is higher. Why is that?**

**Answer:**

The measuring range does not support a sufficient number of pulses at 100% flow. The solution is to adjust the mA output to a lower flow and to keep in mind that the max. flow is not exceeded ( $\leq 20$  mA).

\*\*\*\*\*

**Question:**

**I do not understand the language on the display. What's wrong and how do I fix it?**

**Answer:**

For example lightning and a too noisy environment can have caused the problem.

The solution is to perform a system reset by pressing all four display keys simultaneously. The default language, English, will consequently be the display language (that you can change to your native language if required).

\*\*\*\*\*

**Question:**

**Can I always allow up to 50 meters between the sensor and the converter?**

**Answer:**

It really depends on the cabling and the amount of electrical noise in the vicinity. Avoid running in parallel with high voltage and other power lines. If that is not possible, the converter must be installed closer to the sensor.

\*\*\*\*\*

## Appendix D. Front Panel Cut-out Drawing

The dotted line indicates the front panel outline and measures 155 x 145 mm.

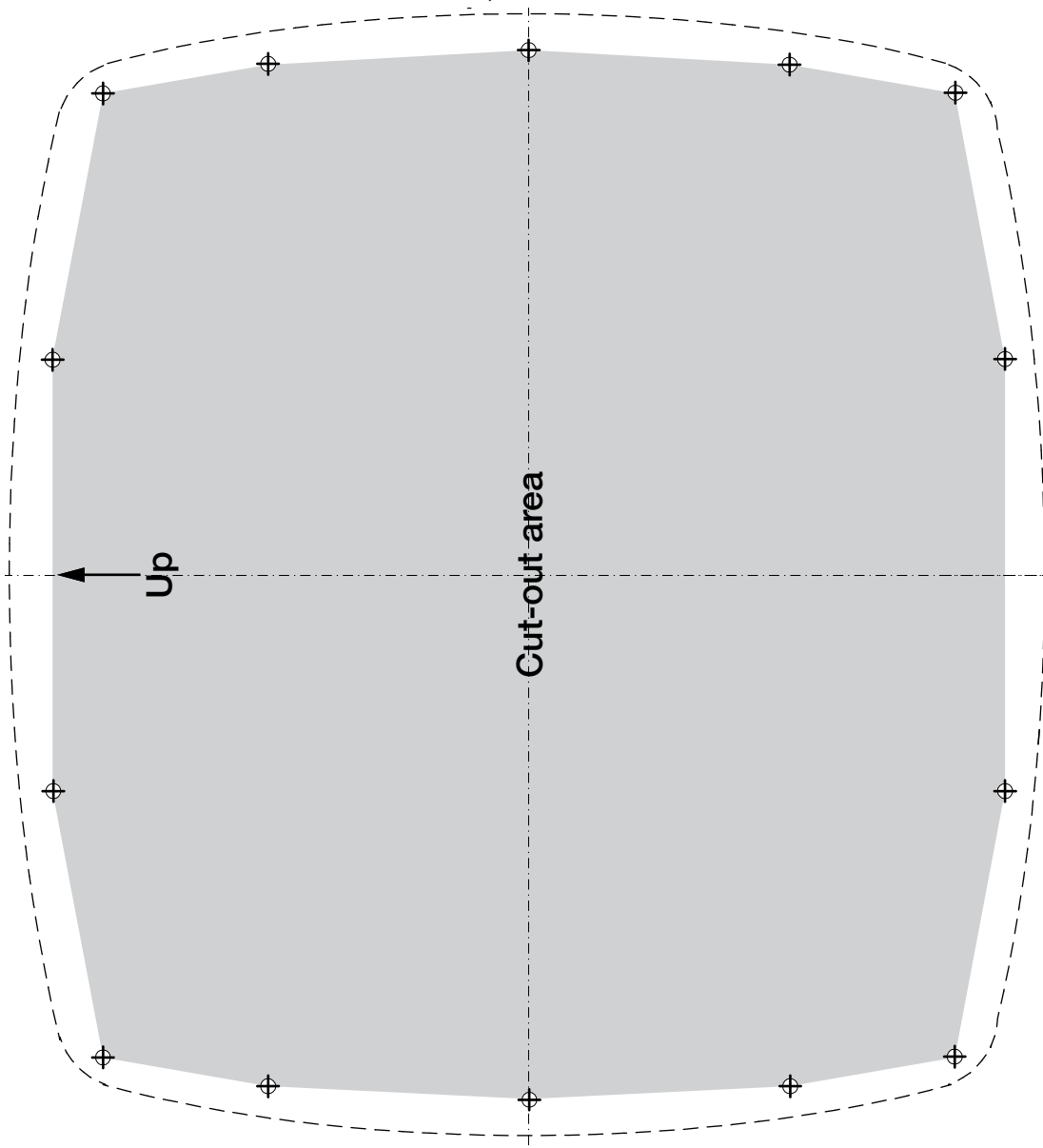

# Appendix E. Test Certificate

## TEST CERTIFICATE

### MagFlux® Flow Meter

**FLOW SENSOR**

Part no.: **207222**  
Serial no.: **23734**  
Calibration code: **au2921**

**SENSOR SPECIFICATIONS**

Size: **DN50**  
Protection: **IP67**  
Pressure rating: **PN16**  
Lining: **Hard rubber**  
Electrodes: **AISI 316 TI**  
Media temp.: **-10 to 80°C**

**Test conditions:**

The meter tests were carried by a volume method with flying start.

**Test facility:**

Helios AG, SRN electro-mechanical weighing machines of capacities 4800 kgs production series numbers 9229012, 47583.  
Last calibration date 27th December 2006, calibration sheets No. 305-KL-V347-06.

**Test results:**

Deviation 0,09 % at a velocity of 0,5 m/s  
Deviation 0,01 % at a velocity of 1,5 m/s  
Deviation 0,00 % at a velocity of 6,5 m/s

**DATE**

31 January 2007

**SIGNATURE**

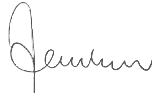

MJK Automation A/S  
Byageren 7  
DK - 2850 Nærum  
Denmark

Tel: +45 45 56 06 56  
Fax: +45 45 56 06 46

mjk@mjk.com  
www.mjk.com

## Appendix F. Log Files

The example log file shown below is the result of a CSV file from the converter having been opened in with Microsoft® Excel® spread sheet utility.

This example below illustrates four MagFlux converters being logged every 10 secs.

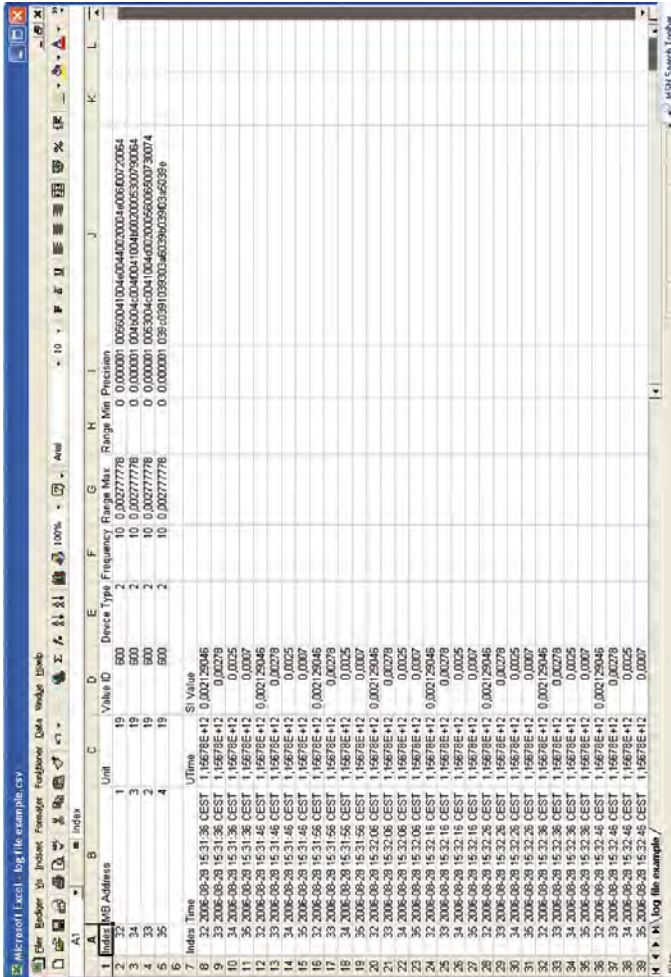

Index	MB Address	Unit	Value	S Value	Direct Type	Frequency	Range Max	Range Min	Precision	ID
1	32	1	19	0.00277778	0	0.000001	0.00650041004604000004006600720064	0	0.000001	00650041004604000004006600720064
2	32	2	19	0.00277778	0	0.000001	0.00650041004604000004006600720064	0	0.000001	00650041004604000004006600720064
3	34	3	19	0.00277778	0	0.000001	0.00650041004604000004006600720064	0	0.000001	00650041004604000004006600720064
4	34	4	19	0.00277778	0	0.000001	0.00650041004604000004006600720064	0	0.000001	00650041004604000004006600720064
5	35	3	19	0.00277778	0	0.000001	0.00650041004604000004006600720064	0	0.000001	00650041004604000004006600720064
6	35	4	19	0.00277778	0	0.000001	0.00650041004604000004006600720064	0	0.000001	00650041004604000004006600720064
7										
8	32	006-09-29	15.31.36	CEST	1.5678E+12	0.00279046				
9	33	006-09-29	15.31.36	CEST	1.5678E+12	0.00279				
10	34	006-09-29	15.31.36	CEST	1.5678E+12	0.0025				
11	35	006-09-29	15.31.36	CEST	1.5678E+12	0.0007				
12	32	006-09-29	15.31.46	CEST	1.5678E+12	0.00279046				
13	33	006-09-29	15.31.46	CEST	1.5678E+12	0.0025				
14	34	006-09-29	15.31.46	CEST	1.5678E+12	0.0007				
15	35	006-09-29	15.31.46	CEST	1.5678E+12	0.0007				
16	32	006-09-29	15.31.56	CEST	1.5678E+12	0.00279046				
17	33	006-09-29	15.31.56	CEST	1.5678E+12	0.00279				
18	34	006-09-29	15.31.56	CEST	1.5678E+12	0.0025				
19	35	006-09-29	15.31.56	CEST	1.5678E+12	0.0007				
20	32	006-09-29	15.32.06	CEST	1.5678E+12	0.00279046				
21	33	006-09-29	15.32.06	CEST	1.5678E+12	0.00279				
22	34	006-09-29	15.32.06	CEST	1.5678E+12	0.0025				
23	35	006-09-29	15.32.06	CEST	1.5678E+12	0.0007				
24	32	006-09-29	15.32.16	CEST	1.5678E+12	0.00279046				
25	33	006-09-29	15.32.16	CEST	1.5678E+12	0.00279				
26	34	006-09-29	15.32.16	CEST	1.5678E+12	0.0025				
27	35	006-09-29	15.32.16	CEST	1.5678E+12	0.0007				
28	32	006-09-29	15.32.26	CEST	1.5678E+12	0.00279046				
29	33	006-09-29	15.32.26	CEST	1.5678E+12	0.00279				
30	34	006-09-29	15.32.26	CEST	1.5678E+12	0.0025				
31	35	006-09-29	15.32.26	CEST	1.5678E+12	0.0007				
32	32	006-09-29	15.32.36	CEST	1.5678E+12	0.00279046				
33	33	006-09-29	15.32.36	CEST	1.5678E+12	0.00279				
34	34	006-09-29	15.32.36	CEST	1.5678E+12	0.0025				
35	35	006-09-29	15.32.36	CEST	1.5678E+12	0.0007				
36	32	006-09-29	15.32.46	CEST	1.5678E+12	0.00279046				
37	33	006-09-29	15.32.46	CEST	1.5678E+12	0.00279				
38	34	006-09-29	15.32.46	CEST	1.5678E+12	0.0025				
39	35	006-09-29	15.32.46	CEST	1.5678E+12	0.0007				

The entries are described on the following page.



- Index** Converter ID (here 4 converters: 32, 33, 34 and 35)
- MB Address** Modbus address (here: 1, 2, 3 and 4)
- Unit** SI unit according to the MJK unit codes (here: 19 = m<sup>3</sup>/h)

MJK Unit Codes		
Code no.	Unit	
16	GPM	gallons per minute
17	l/min	litres per minute
19	m <sup>3</sup> /h	cubic meters per hour
23	MGD	million gallons per day
24	l/sec	litres per second
28	m <sup>3</sup> /sec	cubic meters per second
57	%	percent
95	mg/l	milligrams per litre
96	kg/l	kilograms per litre
97	g/l	grams per litre
130	ft <sup>3</sup> /h	cubic feet per hour
138	l/h	litres per hour
139	ppm	parts per million
246	NTU	Nephelometric Turbidity Units
248	FNU	Formazin Nephelometric Units
249	EBC	European Brewing Convention
250	FTU	Formazine Turbidity Units

- Value ID** Modbus address for flow (here: 600)
- Device Type** The device type (here: 2 = MagFlux)
- Frequency** Log interval in seconds (here: 10 seconds)
- Range Max** Maximum value for graph
- Range Min** Minimum value for graph
- Precision** The precision of the SI value
- Column J** The sensor name as entered by the operator.
- Time** Date and time in Central European Standard Time (CEST)
- UTime** The time in UNIX format. Number of seconds since January 1, 1970
- SI Value** The value in SI units (**S**ystème **I**nternational d'Unités) (here: m<sup>3</sup>/h)

To plot the log file's data, proceed as follows:

1. Start Excel and open the csv log file.
2. Sort by "Index", click the "Diagram Guide" tool in the toolbar and select the required curve or graph (see example below).

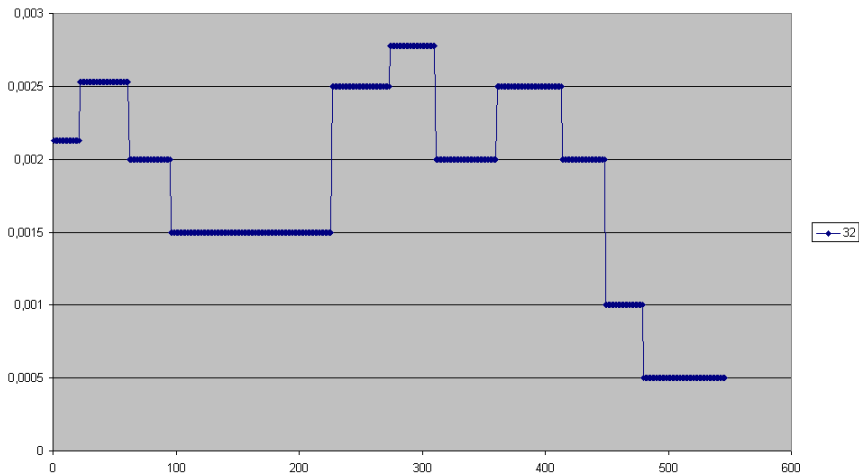

## Appendix G. Digital Input/Output Connections

The digital in- and outputs, DI and DO, can be inter-connected to external equipment to achieve a number of functions such as alarms, counter reset, flow direction indication, etc.

The two schematics below illustrate a simplified mode of operation.

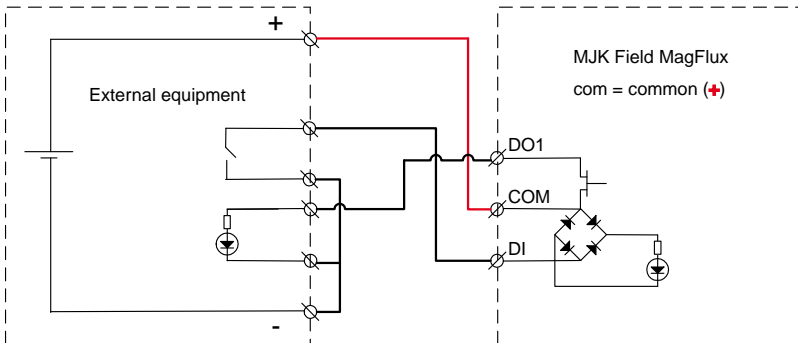
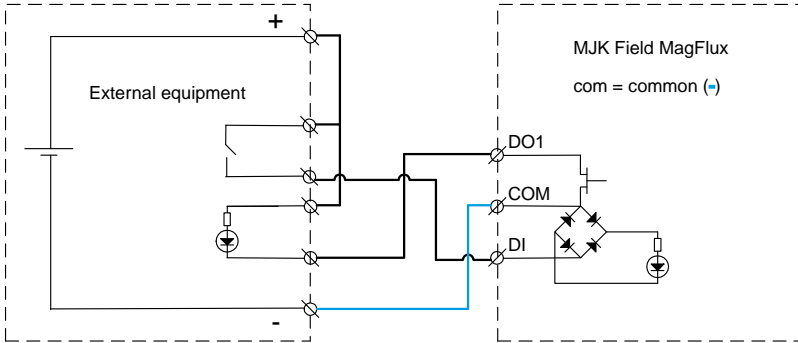

## Appendix H. Remote Slave Display Unit

This example describes the cable connections and display configurations for one MagFlux converter with a local "master" display unit and one remote "slave" display unit.

### Connection Board - with a remote "slave" display unit

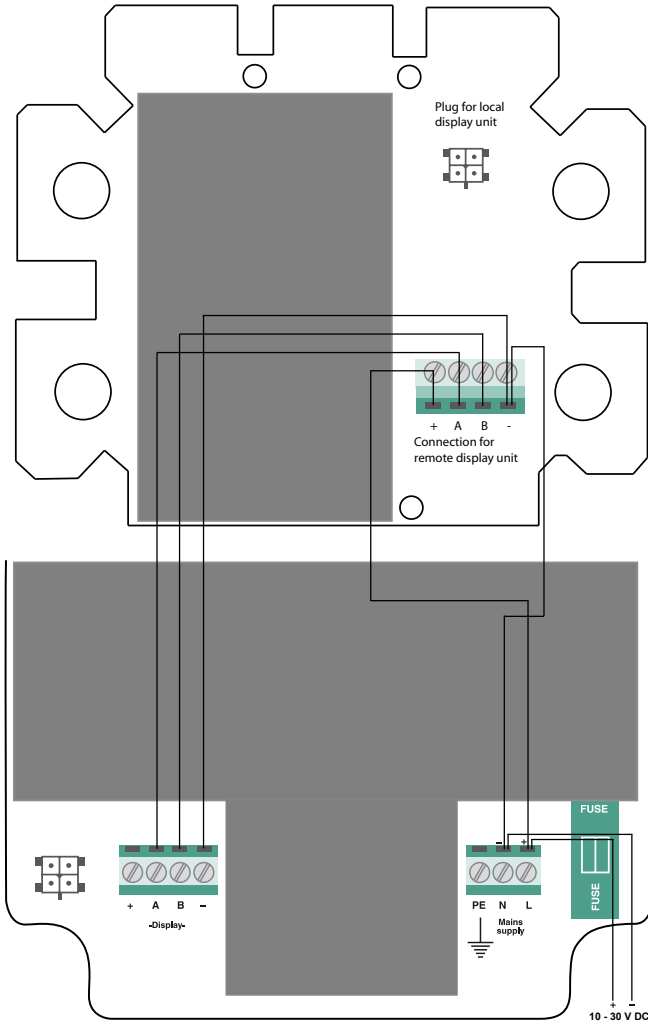

## Converter Connection Board - with a "master" display unit

### Wiring

1. Connect a lead between:  
"Display, A" on the *Converter Connection Board* to  
" **Connection for remote display unit, A**" on the *Connection Board*.
2. Connect a lead between:  
"Display, B" on the *Converter Connection Board* to  
" **Connection for remote display unit, B**" on the *Connection Board*.
3. Connect a lead between:  
"Display, -" on the *Converter Connection Board* to  
" **Connection for remote display unit, -**" on the *Connection Board*.
4. Connect a lead between:  
"Mains supply, L" on the *Converter Connection Board* to  
" **Connection for remote display unit, +**" on the *Connection Board*.
5. Connect a lead between:  
"Mains supply, N" on the *Converter Connection Board* to  
" **Connection for remote display unit, -**" on the *Connection Board*.
6. Connect two leads between:  
"Mains supply, L and N" on the *Converter Connection Board* to  
an external 10 - 30 V DC power supply
7. Connect the earth terminals to earth as required.
8. Turn on power (10 - 30 V DC) to the *Converter Connection Board*.

### Configuration for the master unit

1. Press "**Setup**" and select "**Display Setup**".
2. Select "**Modbus**" and "**Change Display ID No.**".
3. Change the display ID no. to "**1**" (if different from "1").
4. Change the "**Number of Displays**" to "**2**".

### Configuration for the slave unit

1. Press "**Setup**" and select "**Display Setup**".
2. Select "**Modbus**" and "**Change Display ID No.**".
3. Change the display ID no. to "**2**".
4. Change the "**Number of Displays**" to "**2**".

# Main Menu Overview

The size of this manual does not provide sufficient space for showing the complete, contiguous menu structure.

As a compensation a cut-up presentation of the menu structure is shown on the following pages.

## Main Menu Overview

### Main Menu

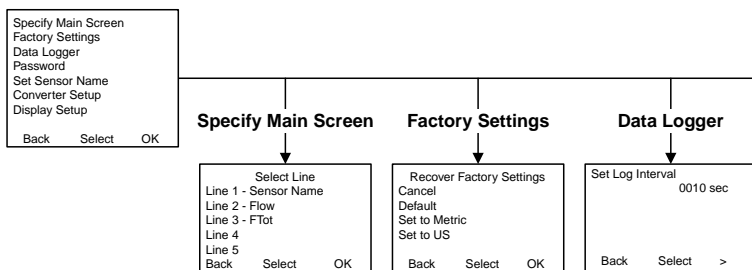

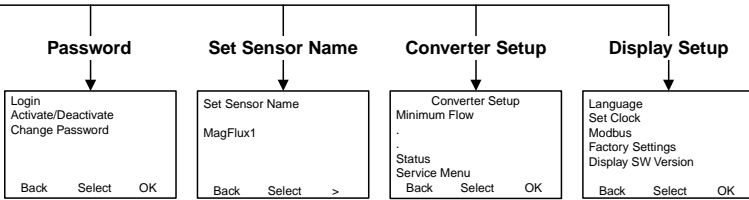

# Converter Setup Menu Overview

The size of this manual does not provide sufficient space for showing the complete, contiguous menu structure.

As a compensation a cut-up presentation of the menu structure is shown on the following pages.

## Converter Setup Menu Overview

### Converter Setup

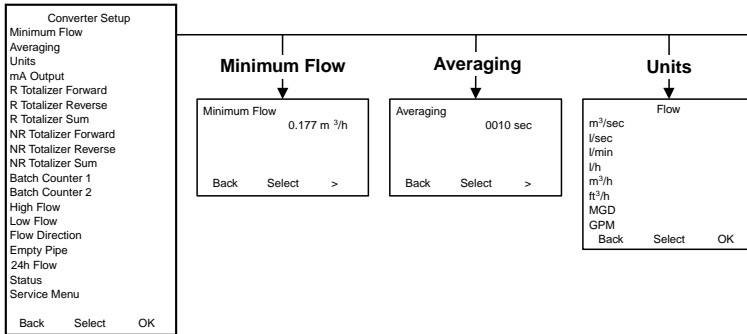

### Main Menu

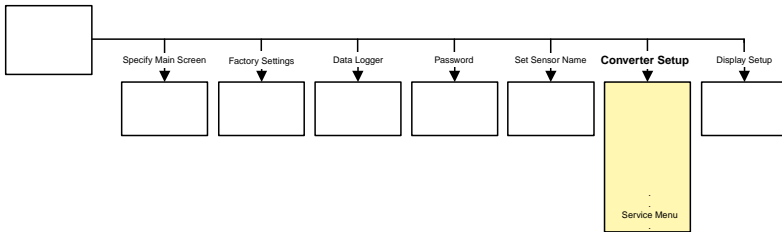



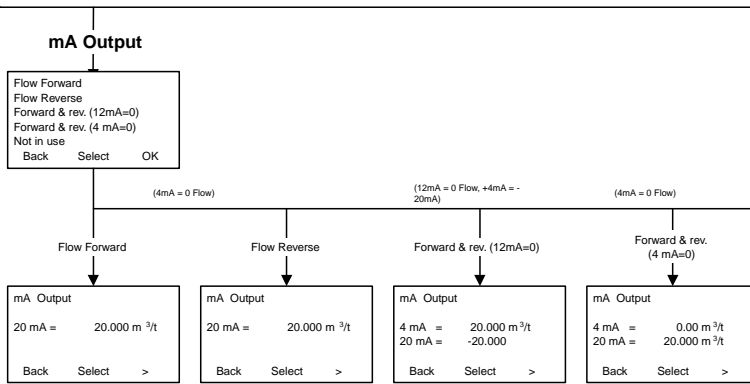

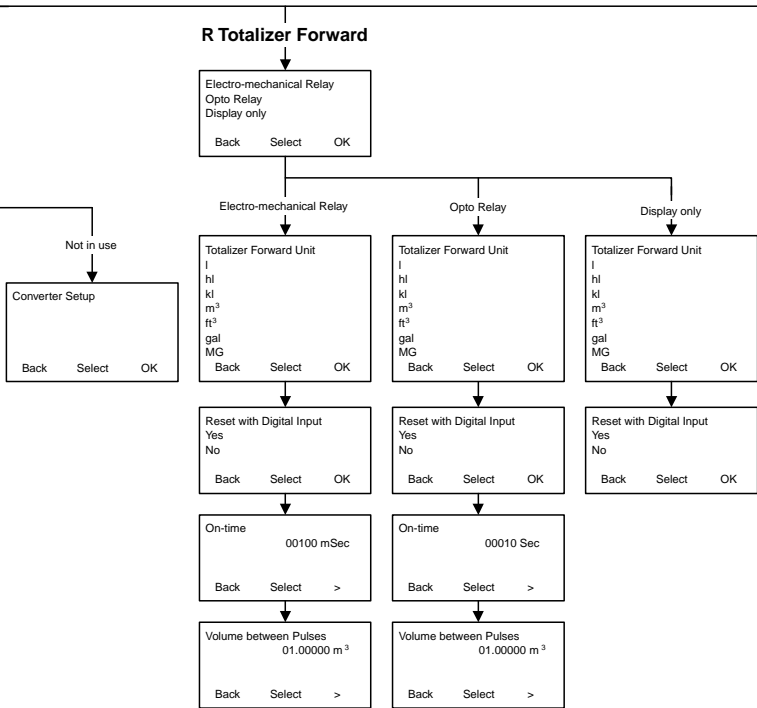

**R Totalizer Reverse**

Electro-mechanical Relay  
 Opto Relay  
 Display only  
 Back Select OK

Electro-mechanical Relay

Opto Relay

Display only

Totalizer Forward Unit  
 l  
 hl  
 kl  
 m<sup>3</sup>  
 ft<sup>3</sup>  
 gal  
 MG  
 Back Select OK

Totalizer Forward Unit  
 l  
 hl  
 kl  
 m<sup>3</sup>  
 ft<sup>3</sup>  
 gal  
 MG  
 Back Select OK

Totalizer Forward Unit  
 l  
 hl  
 kl  
 m<sup>3</sup>  
 ft<sup>3</sup>  
 gal  
 MG  
 Back Select OK

Reset with Digital Input  
 Yes  
 No  
 Back Select OK

Reset with Digital Input  
 Yes  
 No  
 Back Select OK

Reset with Digital Input  
 Yes  
 No  
 Back Select OK

On-time  
 00100 mSec  
 Back Select >

On-time  
 00100 mSec  
 Back Select >

Volume between Pulses  
 01.00000 m<sup>3</sup>  
 Back Select >

Volume between Pulses  
 01.00000 m<sup>3</sup>  
 Back Select >

**R Totalizer Sum**

Totalizer Forward Unit  
 l  
 hl  
 kl  
 m<sup>3</sup>  
 ft<sup>3</sup>  
 gal  
 MG  
 Back Select OK

Reset with Digital Input  
 Yes  
 No  
 Back Select OK

NR Totalizer Forward

Totalizer Forward Unit
l
hl
kl
m <sup>3</sup>
ft <sup>3</sup>
gal
MG
Back Select OK

NR Totalizer Reverse

Totalizer Reverse Unit
l
hl
kl
m <sup>3</sup>
ft <sup>3</sup>
gal
MG
Back Select OK

NR Totalizer Sum

Totalizer total Unit
l
hl
kl
m <sup>3</sup>
ft <sup>3</sup>
gal
MG
Back Select OK

Batch Counter 1

Electro-mechanical Relay
Opto Relay
Not in use
Back Select OK

Electro-mechanical Relay

Batch Counter 1 Unit
l
hl
kl
m <sup>3</sup>
ft <sup>3</sup>
gal
MG
Back Select OK

Pause with Digital Input
Yes
No
Back Select OK

Resetting the Batch Counter 1
Automatic
Manually
Adaptive
Back Select OK

Automatic

On-time
00100 mSec
Back Select >

Number of preselected (Units)
00.002778 m <sup>3</sup>
Back Select >

**Batch Counter 2**

Electro-mechanical Relay  
 Opto Relay  
 Not in use  
 Back Select OK

Opto Relay

Not in use

Electro-mechanical Relay

Opto Relay

Batch Counter 1 Unit  
 l  
 hl  
 kl  
 m<sup>3</sup>  
 ft<sup>3</sup>  
 gal  
 MG  
 Back Select OK

Converter Setup  
 Back Select OK

Batch Counter 2 Unit  
 l  
 hl  
 kl  
 m<sup>3</sup>  
 ft<sup>3</sup>  
 gal  
 MG  
 Back Select OK

Batch Counter 2 Unit  
 l  
 hl  
 kl  
 m<sup>3</sup>  
 ft<sup>3</sup>  
 gal  
 MG  
 Back Select OK

Pause with Digital Input  
 Yes  
 No  
 Back Select OK

Pause with Digital Input  
 Yes  
 No  
 Back Select OK

Pause with Digital Input  
 Yes  
 No  
 Back Select OK

Resetting the Batch Counter 1  
 Automatic  
 Manually  
 Adaptive  
 Back Select OK

Resetting the Batch Counter 2  
 Automatic  
 Manually  
 Adaptive  
 Back Select OK

Resetting the Batch Counter 2  
 Automatic  
 Manually  
 Adaptive  
 Back Select OK

Manually

Adaptive

Automatic

Manually

Number of preSelected (Units)  
 00.002778 m<sup>3</sup>  
 Back Select >

Number of preSelected (Units)  
 00.002778 m<sup>3</sup>  
 Back Select >

On-time 00100 mSec  
 Back Select >

Number of preSelected (Units)  
 00.002778 m<sup>3</sup>  
 Back Select >

Maximum Correction  
 20%  
 Back Select >

Number of preselected (Units)  
 00.02778m<sup>3</sup>  
 Back Select >

Reset Batch Error  
 Yes  
 No  
 Back Select OK

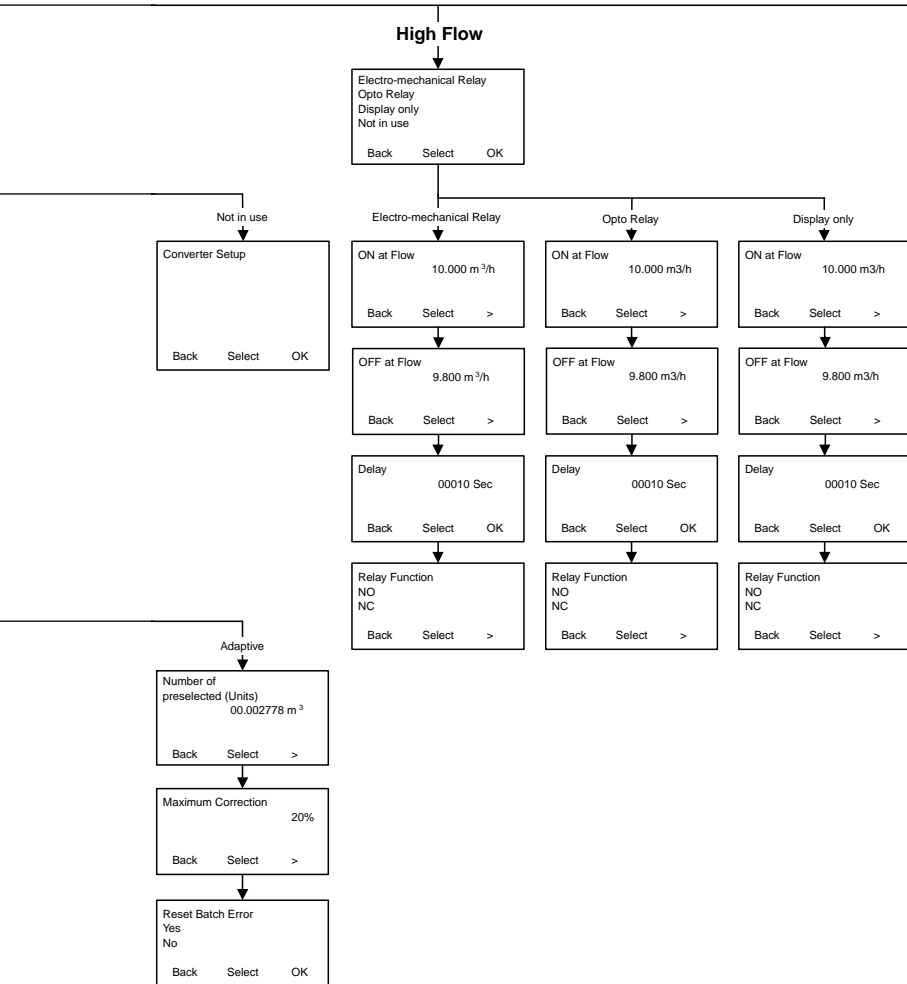

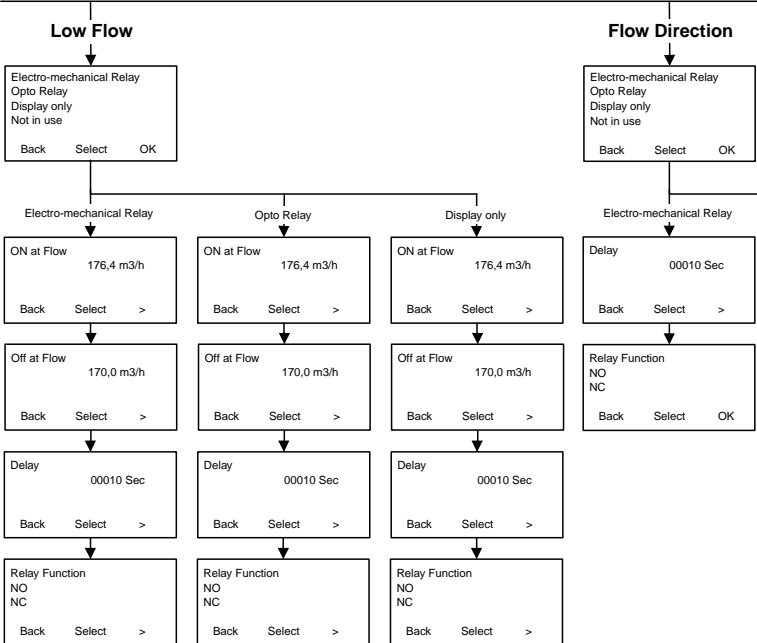

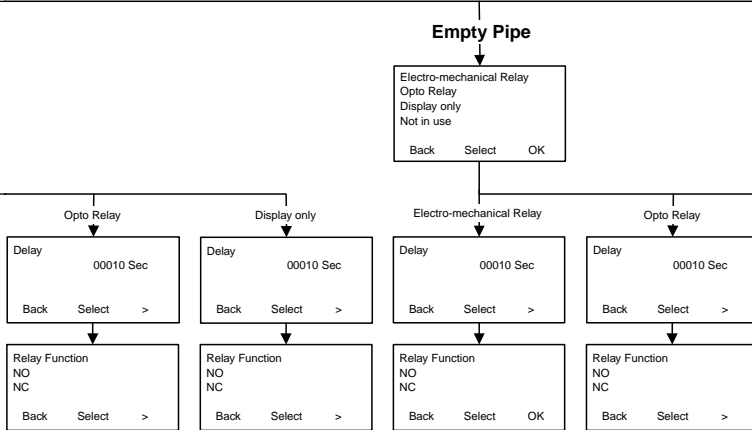



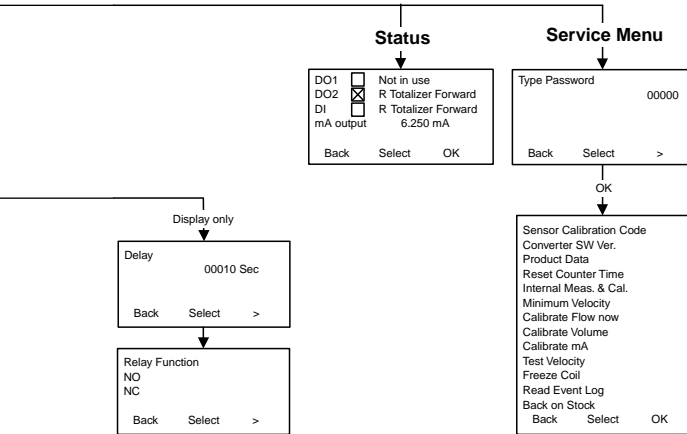

## Service Menu Overview

The size of this manual does not provide sufficient space for showing the complete, contiguous menu structure.

As a compensation a cut-up presentation of the menu structure is shown on the following pages.

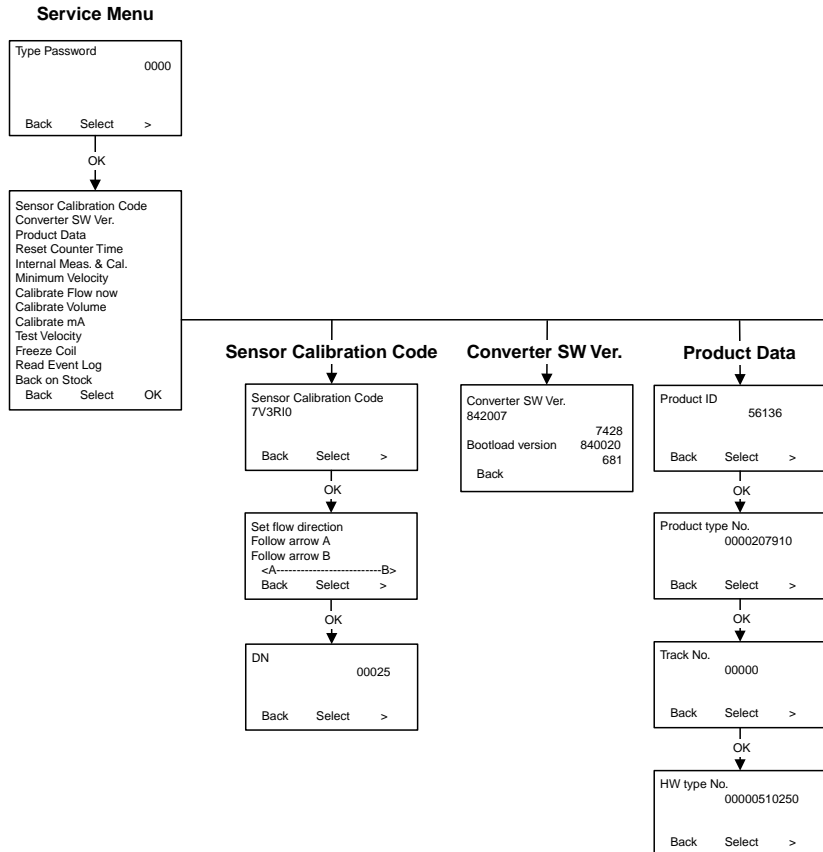

**Reset Counter Time**

Reset Counter	11
System Runtime	1632838
Since reset	426838
Runtime (days)	18
Back	Select >

**Internal Meas. & Cal.**

View Vgate	
Coil Current	
View ADC Factor	
Calibrate Vground	
Calibrate Vref	
View Vwater	
View Raw ADC	
View ADC Current	
Back	Select >

**Minimum Velocity**

Minimum Velocity	0.100 m/sec
Back	Select >

View Vgate

View Vgate	3624
Back	Select >

Coil Current

Coil Current	148
Back	Select >

View ADC Factor

View ADC Factor	4.89011
Back	Select >

View ADC Current

View ADC Current	09893127.00000
Back	Select >

View Raw ADC

Input noise	0.18%
Raw ADC	10791
Gain	4.000
Velocity	5.21656 m/sec
Flow	0.0055786500 m <sup>3</sup> /sec
Back	Select >

View Vwater

View Vwater	0
Back	Select >

**Calibrate Flow now**

View flow now  
0.0019816387 m<sup>3</sup>/sec  
Back Select >

Calibrate ADC Ground

Calibrate ADC ground  
2270  
Back Select >

View/Calibrate Vref

View/Calibrate Vref  
1208  
Back Select >

**Calibration Volume**

Reset counter  
Yes  
No  
Back Select OK

OK

Reset counter  
Yes  
No  
Back Select OK

OK

View counter  
1163.1950000000 m<sup>3</sup>  
Back Select OK

OK

Set volume  
1163.1950000000 m<sup>3</sup>  
Back Select OK

**Calibrate mA**

Current  
Set fixed current  
Calib. current  
DAC zero current  
DAC top current  
Back Select OK

**Test Velocity**

Set velocity  
00.000 m/sec  
Back Select >

OK

Velocity  
4.039745 m/sec  
Flow  
7.136209 m<sup>3</sup>/h  
Back Select OK

OK

Enable test  
Yes  
No  
Back Select OK

**Freeze Coil**

Freeze coil  
Positive  
Negative  
Back Select OK

OK

Freeze coil  
Disable  
Enable  
Back Select OK

**Read Event Log**

No	Hour	Event	Extension
1	1956	0	0
2	1956	3	0
3	1956	205	0
Back		Next	

OK

No	Hour	Event	Extension
18	306	205	0
19	306	208	0
20	163	206	0
Back		OK	

**Back On Stock**

Recover Factory Settings  
Cancel  
Back On Stock  
Back Select OK

## Display Setup Menu Overview

The size of this manual does not provide sufficient space for showing the complete, contiguous menu structure.

As a compensation a cut-up presentation of the menu structure is shown on the following pages.

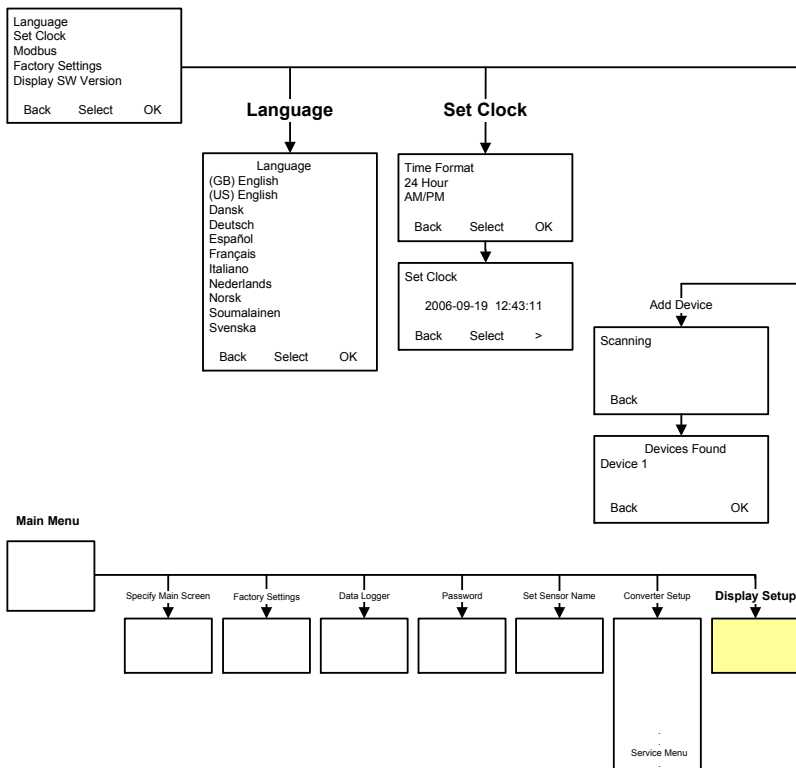

**Modbus**

Add Device  
Change Device Address  
Remove Device  
Change Display ID No.  
Set No. of Retries  
Back Select OK

Change Device Adresse

Change Device Address  
Device 1  
Back Select OK

Change Device 1                      1  
Back Select OK

Remove Device

Remove Device  
Device 1  
Back Select OK

Change Display ID No.

Change Display ID No.  
1  
Back Select OK

Number of Displays  
1  
Back Select OK

Set No. of Retries

Set No. of Retries                      005  
This will reset the display.  
Back Select >

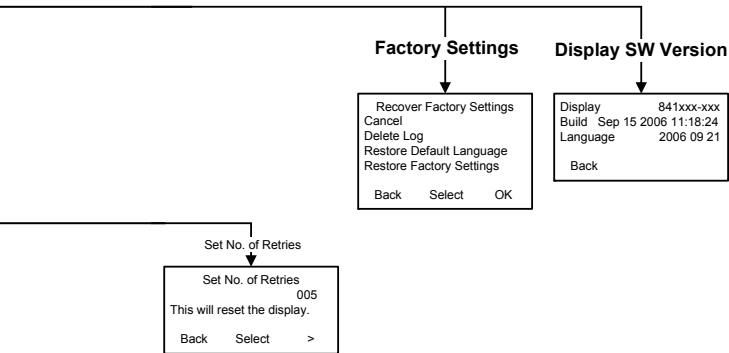



This page intentionally left blank.

Index	
<b>A</b>	
accuracy .....	18
activate/deactivate.....	60
Add Device.....	99
Averaging .....	63
<b>B</b>	
Back on Stock.....	95
batch counter	
adaptive.....	78
automatic .....	76
manual .....	77
<b>C</b>	
Calibrate Flow now .....	91
Calibrate mA.....	92
Calibrate Volume .....	91
Change Device Address .....	100
configurations.....	34, 37
Converter SW Ver. ....	89
<b>D</b>	
data logger.....	56
declaration of conformity .....	2
Delay .....	83, 84, 85
digital input.....	31
Display Setup .....	96, 102
Display SW Version.....	101
DI Totalizer Forward.....	86
DO1 Not in use.....	86
DO2 Totalizer Forward .....	86
<b>E</b>	
electrical mounting .....	26
Empty Pipe.....	85
EN-1092-1 .....	102
<b>F</b>	
Factory Settings .....	101
flanges.....	102
Flow Direction.....	84
Flow Reverse.....	66
Forward & rev. (4mA=0) .....	67
Forward & Rev. (12mA=0).....	66
Freeze Coil .....	94
<b>G</b>	
graph display.....	58
<b>H</b>	
High Flow/Low Flow .....	82
<b>I</b>	
initial checks .....	40
Internal Meas. & Cal. ....	90
<b>L</b>	
language .....	97
Language .....	97
Local Flow Sensor	
connections.....	31
login .....	60
<b>M</b>	
mA output .....	86
mA Output.....	64
menus	
Data Logger.....	56
Display Setup .....	96, 102
Password .....	59
Service Menu.....	87
Specify Main Screen.....	49
Minimum Flow .....	63
Minimum Velocity.....	90
Modbus.....	99
<b>N</b>	
NR Totalizer Forward .....	73
NR Totalizer Reverse.....	73
NR Totalizer Sum.....	73
<b>O</b>	
OFF at Flow.....	83
On at Flow.....	83
On-time .....	68, 79
options	
Activate/Deactivate .....	60

Add Device.....	99	Internal Meas. & Cal.....	90
Averaging .....	63	Language .....	97
Back on Stock.....	95	Login .....	60
Batch 1.....	50	mA output .....	86
Batch 1Cnt.....	51	mA Output.....	64
Batch 1 DN.....	50	Minimum Flow .....	63
Batch 1 Vol.....	51	Minimum Velocity.....	90
Batch 2.....	50, 51	Modbus.....	99
Batch 2 Cnt.....	51	NR Totalizer Forward.....	73
Batch 2 DN.....	50	NR Totalizer Reverse.....	73
Batch 2 Vol.....	51	NR Totalizer Sum .....	73
Calibrate Flow now.....	91	OFF at Flow.....	83
Calibrate mA.....	92	On at Flow.....	83
Calibrate Volume.....	91	On-time .....	68, 79
Change Device Address .....	100	Opto Relay .....	68
Change Password .....	60	Product Data .....	89
Clock.....	51	Read Event Log.....	94
Cnt .....	50	Resetable Totalizer Forward.....	72
Converter SW Ver. ....	89	Resetable Totalizer Reverse .....	72
Delay .....	83	Reset Counter Time.....	90
Display only .....	68	Resettable Totalizer Forward.....	72
Display SW Version.....	101	Reset with Digital Input .....	68
DI Totalizer Forward .....	86	RFTot.....	50
DO1 Not in use.....	86	RRTot .....	50
DO2 Totalizer Forward .....	86	RTot.....	50
Electro-Mechanical relay .....	68	RTTot.....	50
Empty Pipe.....	85	Sensor Name.....	50
Factory Settings.....	101	Status.....	86
Flow .....	50	Test Velocity.....	92
Flow Direction.....	50, 84	Totalizer Forward Unit .....	68, 79
Flow Reverse.....	66	Volume between Pulses.....	69, 79
Forward & rev. (4mA=0) .....	67		
Forward & Rev. (12mA=0).....	66		
Freeze Coil.....	94		
FTot .....	50		
High Flow/Low Flow .....	82		

**P**

password .....	59
password, change.....	60
Product Data .....	89

**R**

Read Event Log.....	94
Relay Function.....	83, 84, 85
Resetable Totalizer Forward.....	72
Resetable Totalizer Reverse.....	72

Reset Counter Time..... 90  
reset, system..... 43  
Resettable Totalizer Forward..... 72  
Reset with Digital Input ..... 68

**S**

safety ..... 14  
Sensor Calibration Code..... 87  
Service Menu ..... 87  
Status..... 86

**T**

Test Velocity..... 92  
Totalizer Forward Unit ..... 68, 79  
totalizers, non-resettable..... 73  
totalizers, resettable..... 71

**V**

Volume between Pulses..... 69, 79

This page intentionally left blank.

## Liability

MJK Automation A/S are liable to the common rules of Danish law on product liability, however, the liability is reduced to coverage of our public liability insurance of products. To the extent where nothing else follows in lines of invariable rules of law, we are not liable for loss of profits and working deficits or other indirect losses.

## Changes

As our products are developed continuously, we reserve the right to make any alterations without prior notice.

MJK Automation A/S  
Byageren 7  
DK-2850 Nærum

[www.mjk.com](http://www.mjk.com)  
[mjk@mjk.com](mailto:mjk@mjk.com)

