

MultiLab 4010-3

DIGITAL METER FOR IDS SENSORS



a xylem brand



For the most recent version of the manual, please visit www.ysi.com.

Contact

YSI
1725 Brannum Lane
Yellow Springs, OH 45387 USA
Tel: +1 937-767-7241
800-765-4974
Email: environmental@ysi.com
Internet: www.ysi.com

Copyright

© 2013 Xylem Inc.

MultiLab 4010-3 - Contents

1	Overview	7
1.1	Meter MultiLab 4010-3	7
1.2	Sensors	8
1.2.1	IDS sensors	8
1.2.2	IDS adapter for analog sensors	9
1.2.3	Automatic sensor recognition	9
2	Safety	10
2.1	Safety information	10
2.1.1	Safety information in the operating manual	10
2.1.2	Safety signs on the meter	10
2.1.3	Further documents providing safety information	10
2.2	Safe operation	10
2.2.1	Authorized use	10
2.2.2	Requirements for safe operation	11
2.2.3	Unauthorized use	11
3	Commissioning	12
3.1	Scope of delivery	12
3.2	Power supply	12
3.3	Initial commissioning	12
3.3.1	Connecting the power pack	13
4	Operation	14
4.1	General operating principles	14
4.1.1	Keypad	14
4.1.2	Display	15
4.1.3	Status information	15
4.1.4	Instrument connectors	16
4.1.5	Channel display	17
4.1.6	Sensor info	17
4.1.7	Display of several sensors in the measuring mode ..	18
4.2	Switching on the meter	19
4.3	Switching off the meter	19
4.4	Login with user name	19
4.5	Navigation	21
4.5.1	Operating modes	21
4.5.2	Measured value display	21
4.5.3	Menus and dialogs	21
4.5.4	Example 1 on navigation: Setting the language	23
4.5.5	Example 2 on navigation: Setting the date and time	25

5	pH value	27
5.1	Measuring	27
5.1.1	Measuring the pH value	27
5.1.2	Measuring the temperature	28
5.2	pH calibration	29
5.2.1	Why calibrate?	29
5.2.2	When do you have to calibrate?	29
5.2.3	Carrying out automatic calibration (AutoCal)	29
5.2.4	Carrying out a manual calibration (ConCal)	32
5.2.5	Calibration points	35
5.2.6	Calibration data	36
5.2.7	Continuous measurement control (CMC function) ..	38
5.2.8	QSC function (sensor quality control)	40
6	ORP voltage	43
6.1	Measuring	43
6.1.1	Measuring the ORP	43
6.1.2	Measuring the relative ORP	44
6.1.3	Measuring the temperature	46
6.2	ORP calibration	46
7	Ion concentration	47
7.1	Measuring	47
7.1.1	Measuring the ion concentration	47
7.1.2	Measuring the temperature	49
7.2	Calibration	50
7.2.1	Why calibrate?	50
7.2.2	When to calibrate?	50
7.2.3	Calibration (ISE Cal)	50
7.2.4	Calibration standards	53
7.2.5	Calibration data	53
7.3	Selecting the measuring method	56
7.3.1	<i>Standard addition</i>	57
7.3.2	<i>Standard subtraction</i>	59
7.3.3	<i>Sample addition</i>	62
7.3.4	<i>Sample subtraction</i>	64
7.3.5	Standard addition with blank value correction (<i>Blank value addition</i>)	66
8	Dissolved oxygen (D.O.)	69
8.1	Measuring	69
8.1.1	Measuring D.O.	69
8.1.2	Measuring the temperature	71
8.2	Calibration	71
8.2.1	Why calibrate?	71
8.2.2	When to calibrate?	71
8.2.3	Calibration procedures	71
8.2.4	1-point calibration	72
8.2.5	2-point calibration	73
8.2.6	Calibration data	75

9	Conductivity	78
9.1	Measuring	78
9.1.1	Measuring the conductivity	78
9.1.2	Measuring the temperature	80
9.2	Temperature compensation	80
9.3	Calibration	81
9.3.1	Why calibrate?	81
9.3.2	When to calibrate?	81
9.3.3	Determining the cell constant (calibration in control standard)	81
9.3.4	Calibration data	82
10	Settings	84
10.1	pH measurement settings	84
10.1.1	Settings for pH measurements	84
10.1.2	Buffer sets for calibration	86
10.1.3	Calibration interval	88
10.2	ORP measurement settings	89
10.3	ISE measurement settings	89
10.4	D.O. measurement settings	92
10.4.1	Settings for D.O. measurement	92
10.4.2	Enter <i>Sensor Cap coefficients</i>	92
10.4.3	<i>Saturation local</i>	92
10.5	Cond measurement settings	92
10.5.1	Settings for IDS conductivity sensors	92
10.6	Sensor-independent settings	96
10.6.1	<i>System</i>	96
10.6.2	<i>Data storage</i>	97
10.6.3	<i>Automatic Stability control</i>	97
10.7	Reset	98
10.7.1	Resetting the measurement settings	98
10.7.2	Resetting the system settings	101
11	Data storage	102
11.1	Manual data storage	102
11.2	Automatic data storage at intervals	102
11.3	Measurement data storage	105
11.3.1	Editing the measurement data storage	105
11.3.2	Erasing the measurement data storage	106
11.3.3	Measurement dataset	106
11.3.4	Storage locations	107
12	Transmitting data	108
12.1	Outputting current measurement data	108
12.2	Transmitting data	108
12.3	Connecting the PC / USB-B interface (<i>USB Device</i>)	108
12.4	Connecting a USB memory device/USB printer (USB-A interface (<i>USB Host</i>))	109
12.5	Options for data transmission to the USB-B (PC) interface and the USB-A (USB printer) interface	110
12.6	Data transmission to the USB-A interface	

(USB memory device)	111
12.7 MultiLab Importer	111
12.8 BOD Analyst Pro	111
13 Maintenance, cleaning, disposal	112
13.1 Maintenance	112
13.1.1 General maintenance activities	112
13.1.2 Exchanging the battery	112
13.2 Cleaning	113
13.3 Packing	113
13.4 Disposal	113
14 What to do if.....	115
14.1 pH	115
14.2 ISE	117
14.3 Dissolved oxygen	118
14.4 Conductivity	118
14.5 General information	119
15 Technical data	121
15.1 Measuring ranges, resolution, accuracy	121
15.2 General data	121
16 Firmware update	126
16.1 Firmware update for the meter MultiLab 4010-3	126
16.2 Firmware-Update for IDS Sensors	127
17 Glossary	128
18 Index	131
19 Appendix	134
19.1 Oxygen solubility table	134
19.2 DO% Calibration values	136
20 Contact Information	137
20.1 Ordering & Technical Support	137
20.2 Service Information	137

1 Overview

1.1 Meter MultiLab 4010-3

The MultiLab 4010-3 meter enables you to perform measurements (pH, U, ISE, conductivity, D.O.) quickly and reliably.

The MultiLab 4010-3 provides the maximum degree of operating comfort, reliability and measuring certainty for all applications.

The MultiLab 4010-3 supports you in your work with the following functions:

- proven calibration procedures
- automatic stability control (AR),
- automatic sensor recognition
- CMC (continuous measurement control)
- QSC (sensor quality control).

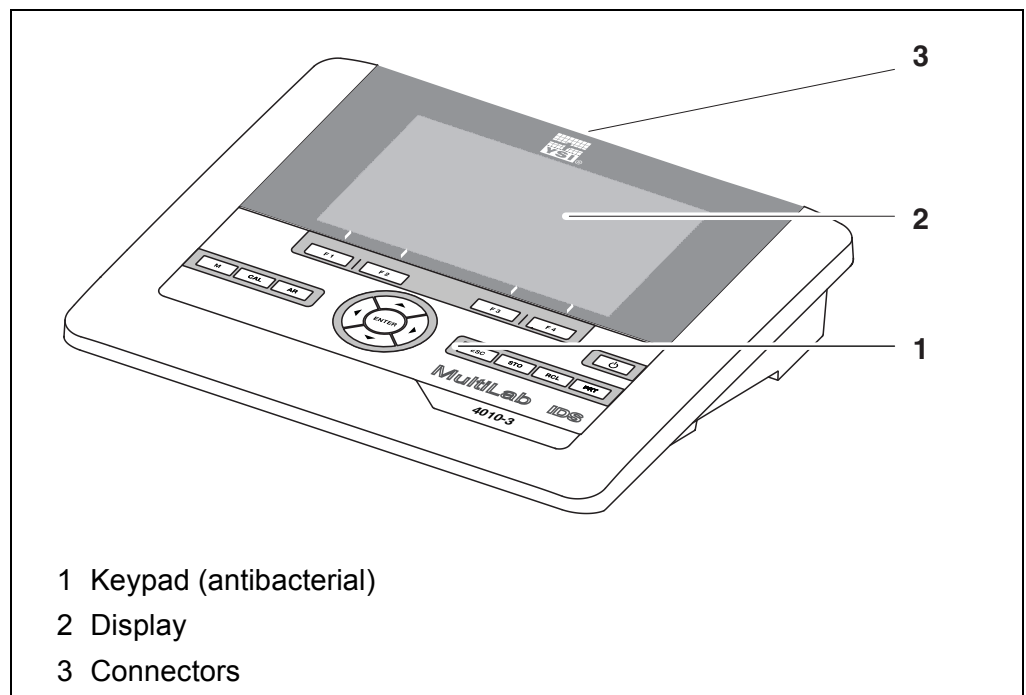

Due to its antibacterial properties, the keypad of the MultiLab 4010-3 is especially suitable for applications in an environment where hygiene is important (see SECTION 15.2 GENERAL DATA, page 121).

1.2 Sensors

1.2.1 IDS sensors

IDS sensors

- support the automatic sensor recognition
- show only the settings relevant to the specific sensor in the setting menu
- process signals in the sensor digitally so that precise and interference-free measurements are enabled even with long cables
- facilitate to assign a sensor to a measured parameter with differently colored couplings
- have quick-lock couplings with which to fix the sensors to the meter.

Sensor data from IDS sensors

IDS sensors transmit the following sensor data to the meter:

- SENSOR ID
 - Sensor name
 - Sensor series number
- Calibration data
- Measurement settings

The calibration data are updated in the IDS sensor after each calibration procedure. A message is displayed while the data are being updated in the sensor.



In the measured value display, you can display the sensor name and series number of the selected sensor with the [Info] softkey. You can then display further sensor data stored in the sensor with the [More] softkey (see section 4.1.6 SENSOR INFO, page 17).

1.2.2 IDS adapter for analog sensors

With the aid of an IDS adapter, you can also operate analog sensors on the MultiLab 4010-3. The combination of the IDS adapter and analog sensor behaves like an IDS sensor.

The MultiLab 4010-3 has a recess where the IDS adapter (ADA 94/IDS DIN or ADA 94/IDS BNC), which is available as an accessory, can be permanently mounted.

The IDS adapter replaces a digital input (channel 2) with a connector for an analog pH/ U/ISE sensor (DIN or BNC plug) and a temperature sensor.

1.2.3 Automatic sensor recognition

The automatic sensor recognition for IDS sensors allows

- to operate an IDS sensor with different meters without recalibrating
- to operate different IDS sensors at one meter without recalibration
- to assign measurement data to an IDS sensor
 - Measurement datasets are always stored and output with the sensor name and sensor series number.
- to assign calibration data to an IDS sensor
 - Calibration data and calibration history are always stored and output with the sensor name and sensor series number.
- to activate the correct cell constant for conductivity sensors automatically
- to hide menus automatically that do not concern this sensor

To be able to use the automatic sensor recognition, a meter that supports the automatic sensor recognition (e.g. MultiLab 4010-3) and a digital IDS sensor are required.

In digital IDS sensors, sensor data are stored that clearly identify the sensor. The sensor data are automatically taken over by the meter.

2 Safety

2.1 Safety information

2.1.1 Safety information in the operating manual

This operating manual provides important information on the safe operation of the meter. Read this operating manual thoroughly and make yourself familiar with the meter before putting it into operation or working with it. The operating manual must be kept in the vicinity of the meter so you can always find the information you need.

Important safety instructions are highlighted in this operating manual. They are indicated by the warning symbol (triangle) in the left column. The signal word (e.g. "Caution") indicates the level of danger:



WARNING

indicates a possibly dangerous situation that can lead to serious (irreversible) injury or death if the safety instruction is not followed.



CAUTION

indicates a possibly dangerous situation that can lead to slight (reversible) injury if the safety instruction is not followed.

NOTE

indicates a possibly dangerous situation where goods might be damaged if the actions mentioned are not taken.

2.1.2 Safety signs on the meter

Note all labels, information signs and safety symbols on the meter. A warning symbol (triangle) without text refers to safety information in this operating manual.

2.1.3 Further documents providing safety information

The following documents provide additional information, which you should observe for your safety when working with the measuring system:

- Operating manuals of sensors and other accessories
- Safety datasheets of calibration or maintenance accessories (such as buffer solutions, electrolyte solutions, etc.)

2.2 Safe operation

2.2.1 Authorized use

The authorized use of the meter consists exclusively of the measurement of the pH, ORP, conductivity and dissolved oxygen in a laboratory environment.

Only the operation and running of the meter according to the instructions and technical specifications given in this operating manual is authorized (see section 15 TECHNICAL DATA, page 121).

Any other use is considered unauthorized.

2.2.2 Requirements for safe operation

Note the following points for safe operation:

- The meter may only be operated according to the authorized use specified above.
- The meter may only be supplied with power by the energy sources mentioned in this operating manual.
- The meter may only be operated under the environmental conditions mentioned in this operating manual.
- The meter may not be opened.

2.2.3 Unauthorized use

The meter must not be put into operation if:

- it is visibly damaged (e.g. after being transported)
- it was stored under adverse conditions for a lengthy period of time (storing conditions, see section 15 TECHNICAL DATA, page 121).

3 Commissioning

3.1 Scope of delivery

- MeterMultiLab 4010-3
- USB cable (A plug on mini B plug)
- Power pack
- Stand with stand base
- Short instructions
- Detailed operating manual
- CD-ROM

3.2 Power supply

The MultiLab 4010-3 is supplied with power in the following ways:

- Mains operation with the supplied power pack
- Operation of the system clock with a buffer battery if there is no mains power supply (see section 13.1.2 EXCHANGING THE BATTERY, page 112).

3.3 Initial commissioning

Perform the following activities:

- Connect the power pack
(see section 3.3.1 CONNECTING THE POWER PACK, page 13)
- Switch on the meter
(see section 4.2 SWITCHING ON THE METER, page 19)
- Set the date and time
(see section 4.5.5 EXAMPLE 2 ON NAVIGATION: SETTING THE DATE AND TIME, page 25)
- Mount the stand
(see operating manual of the stand)

3.3.1 Connecting the power pack

**CAUTION**

The line voltage at the operating site must lie within the input voltage range of the original power pack (see section 15.2 GENERAL DATA, page 121).

**CAUTION**

Use original power packs only (see section 15.2 GENERAL DATA, page 121).

1. Connect the plug of the power pack to the socket for the power pack on the MultiLab 4010-3.
2. Connect the original power pack to an easily accessible power outlet. The meter performs a self-test.









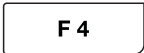

4 Operation

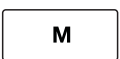
4.1 General operating principles

4.1.1 Keypad

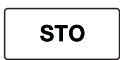
In this operating manual, keys are indicated by brackets <.> .

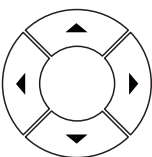
The key symbol (e.g. <ENTER>) generally indicates a short keystroke (press and release) in this operating manual. A long keystroke (hold for approx. 2 sec) is indicated by the underscore behind the key symbol (e.g. <ENTER_>).

	<F1> <F4>	Softkeys providing situation dependent functions, e.g.: <F1>/[Info]: View information on a sensor
		
	<On/Off>	Switches the meter on or off
	<M>	Selects the measured parameter
	<CAL> <CAL_>	Calls up the calibration procedure Displays the calibration data
	<AR>	Freezes the measured value (HOLD function) Switches the AutoRead measurement on or off
	<ESC>	Switches back to the higher menu level / Cancels inputs
	<STO> <STO_>	Saves a measured value manually Opens the menu for the automatic save function
	<RCL> <RCL_>	Displays the manually stored measured values Displays the automatically stored measured values
	<▲><▼> <◀><▶>	Menu control, navigation
	<ENTER> <ENTER_>	Opens the menu for measurement settings / Confirms entries Opens the menu for system settings
	<PRT> <PRT_>	Outputs stored data to the interface Outputs displayed data to the interface at intervals



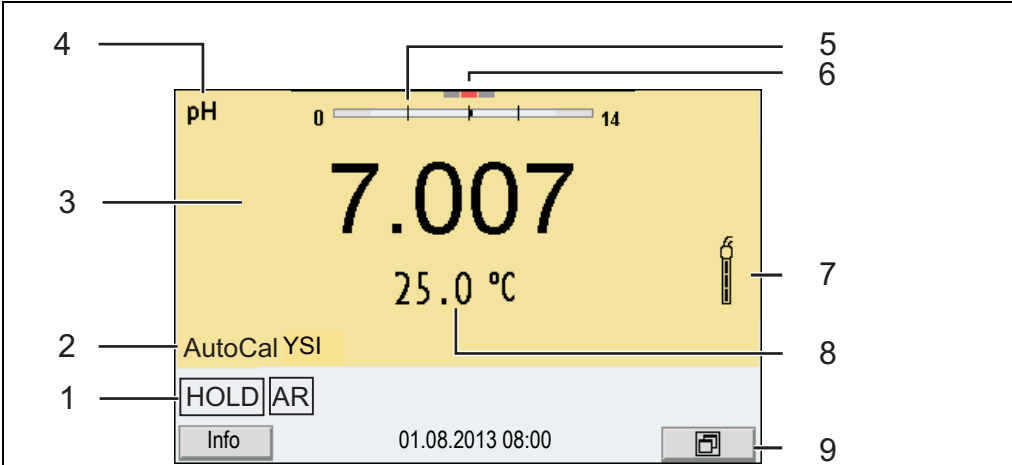

4.1.2 Display

Example (pH):



1 Status information (meter)
 2 Status information (sensor)
 3 Measured value
 4 Measured parameter
 5 Continuous measurement control (CMC function)
 6 Channel display: Plug position of the sensor
 7 Sensor symbol (calibration evaluation, calibration interval)
 8 Measured temperature (with unit)
 9 Softkeys and date + time

4.1.3 Status information

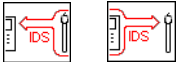
AutoCal e.g. YSI	Calibration with automatic buffer recognition, e.g. with the buffer set: YSI buffers
ConCal	Calibration with any buffers
Error	An error occurred during calibration
AR	Stability control (AutoRead) is active
HOLD	Measured value is frozen (<AR> key)
	Data are automatically output to the USB-B interface at intervals
	Data are output to the USB-A interface (USB flash drive)
	Data are output to the USB-A interface (USB printer). If there is a USB-B connection at the same time (e.g. to a PC), the data are output to the USB-B interface only.
	Connection to a PC is active (USB-B interface)
	Data transfer from/to a IDS sensor is active

4.1.4 Instrument connectors

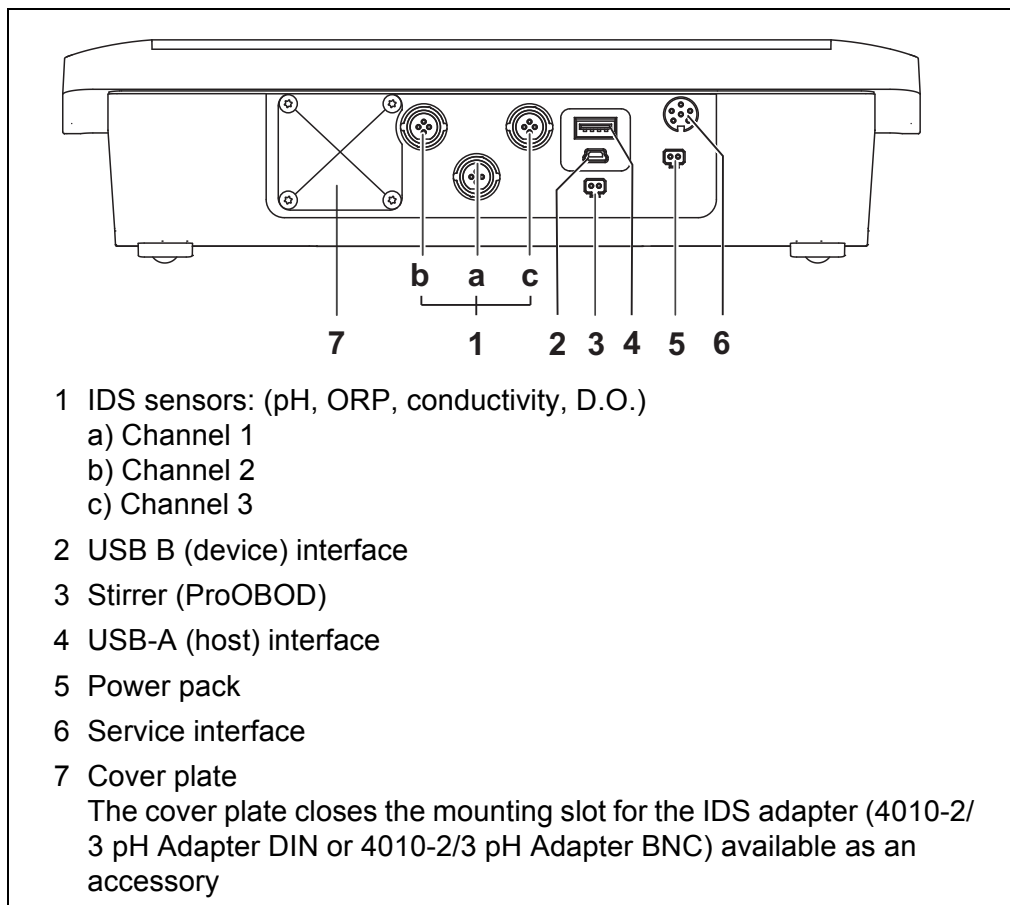

CAUTION

Only connect sensors to the meter that cannot return any voltages or currents that are not allowed ($>$ SELV and $>$ current circuit with current limiting).

YSI IDS sensors and IDS adapters meet these requirements.

4.1.5 Channel display

The MultiLab 4010-3 manages the connected sensors and displays which sensor is plugged to which connection.

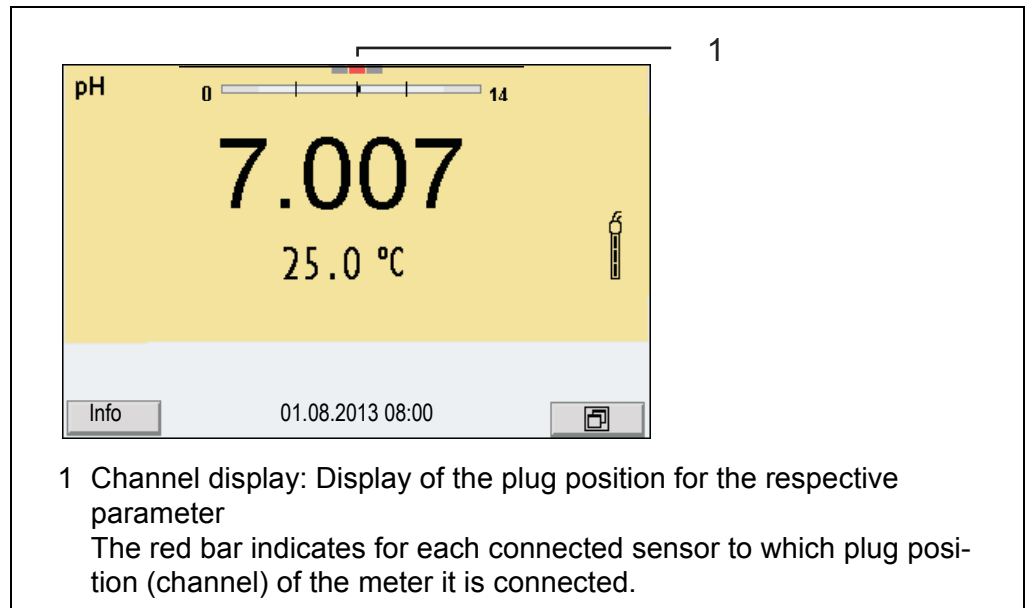

4.1.6 Sensor info

You can display the current sensor data and sensor settings of a connected sensor at any time. The sensor data are available in the measured value display with the *[Info]* softkey.

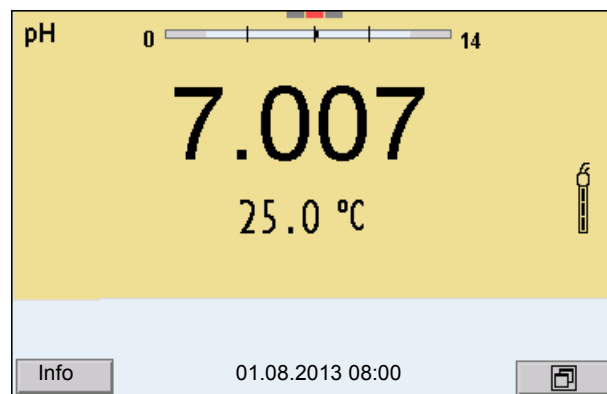

1. In the measured value display:
Display the sensor data (sensor name, series number) with *[Info]*.

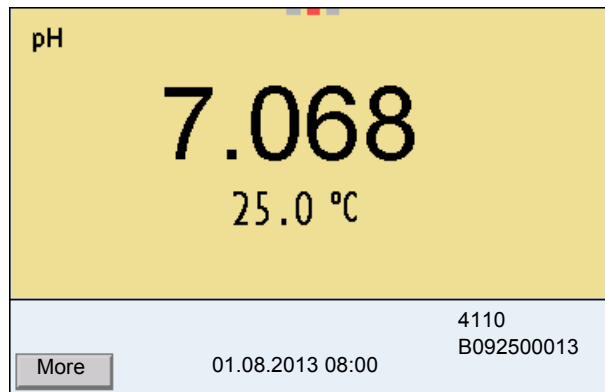

2. Display further sensor data (settings) with [More].

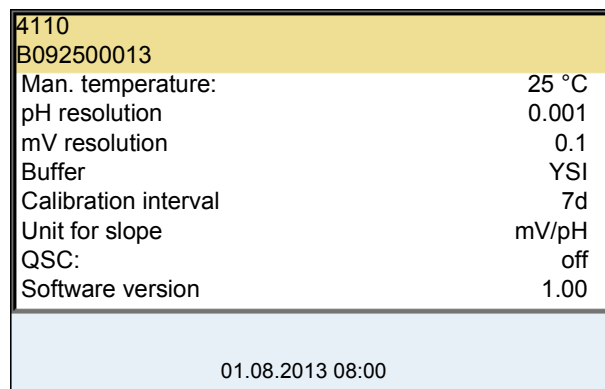

4.1.7 Display of several sensors in the measuring mode

The measured values of the connected sensors can be displayed in the following ways:

- Clear display of all connected sensors
- Detailed display of one sensor (e.g. incl. CMC feature with pH sensors)

With the softkey you can very easily switch between the two display types. The suitable softkey is displayed depending on the operating situation.

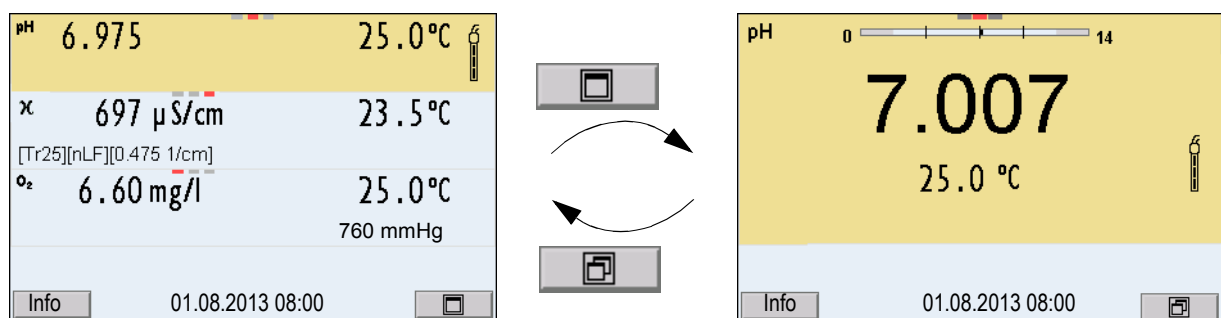

4.2 Switching on the meter

1. Switch the meter on with **<On/Off>**.
The meter performs a self-test.
2. Connect the sensor.
The meter is ready to measure.

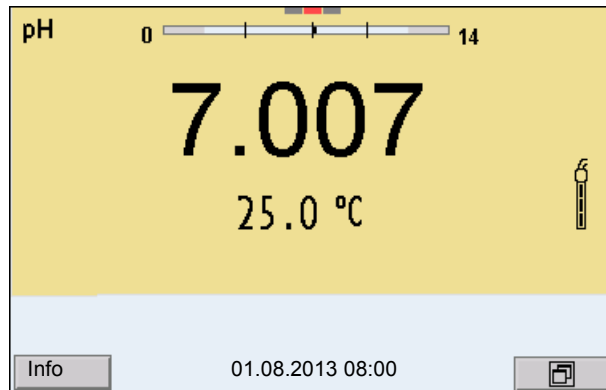

If the user administration function is activated, the *Login* dialog appears after the meter is switched on (see section 4.4 LOGIN WITH USER NAME, page 19).

The user administration function is not active in the delivery condition.

4.3 Switching off the meter

1. Switch off the meter with **<On/Off>**.

4.4 Login with user name

After activation of the user administration (see the *MultiLab User* operating manual) by the administrator, measurements are only possible after login with a user name. The user name is documented with the measured values and in records.

All user names entered by the administrator are listed in the *User name* menu. The administrator determines for each user whether or not a password is required for the login to the meter.

If the *Password* menu item is grayed out, no password is required for the login.

1. Switch on the meter with **<On/Off>**.
The *Login* dialog appears.

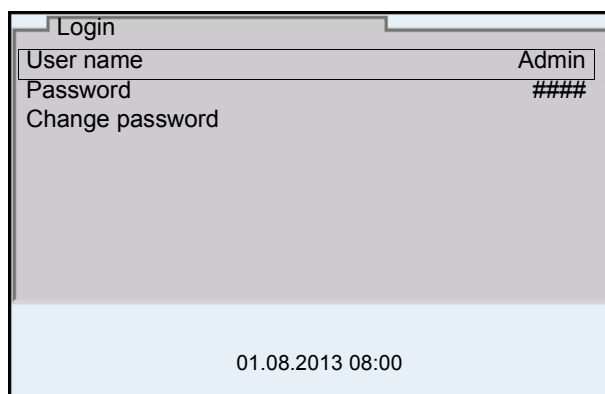

2. Using **<▲><▼>**, select the menu item, *User name* and confirm with **<ENTER>**.
The user name is highlighted.
3. Using **<▲><▼>**, select a user name and confirm with **<ENTER>**.



The login is done immediately if no password is required.
If a sensor is connected the measured value display appears.

4. If a password is required:
Using **<▲><▼>**, select the menu item, *Password* and confirm with **<ENTER>**.



The user specifies the password when he or she first logs in with a user name.
A valid password consists of 4 digits.
The user can change the password with the next login.

5. Change the digit of the highlighted position with **<▲><▼>**.
Switch to the next position of the password with **<◀><▶>**.
When the password was completely entered, confirm with **<ENTER>**.
The login takes place. If a sensor is connected the measured value display appears.

Changing the password

If the administrator has set up the access with password protection:

1. Switch on the meter with **<On/Off>**.
The *Login* dialog appears.
2. Using **<▲><▼>**, select the menu item, *User name* and confirm with **<ENTER>**.
The user name is highlighted.
3. Using **<▲><▼>**, select a user name and confirm with **<ENTER>**.
4. Using **<▲><▼>**, select the menu item, *Change password* and confirm with **<ENTER>**.

5. In the *Password* field, enter the old password with <▲><▼> and <◀><▶> and confirm it with <ENTER>.
6. In the *New password* field, enter the new password with <▲><▼> and <◀><▶> and confirm it with <ENTER>.
The password is changed.
The login takes place. If a sensor is connected the measured value display appears.

Forgotten the password?

Contact the administrator.

4.5 Navigation

4.5.1 Operating modes

Operating mode	Explanation
Measuring	The measurement data of the connected sensor are shown in the measured value display
Calibration	The course of a calibration with calibration information, functions and settings is displayed
Storage in memory	The meter stores measuring data automatically or manually
Transmitting data	The meter transmits measuring data and calibration records to a USB interface automatically or manually.
Setting	The system menu or a sensor menu with submenus, settings and functions is displayed

4.5.2 Measured value display

In the measured value display, you can

- use <▲><▼> to select one of several connected sensors. The selected sensor is displayed with a colored background.
The following actions / menus refer to the selected sensor
- open the menu for calibration and measurement settings with <ENTER> (short keystroke)
- open the *Storage & config* menu with the sensor-independent settings by pressing <ENTER_> (long keystroke, approx. 2 s).
- change the display in the selected measuring screen (e. g. pH <-> mV) by pressing <M>.

4.5.3 Menus and dialogs

The menus for settings and dialogs in procedures contain further subelements.

The selection is made with the <▲><▼> keys. The current selection is displayed with a frame.

- Submenus

The name of the submenu is displayed at the upper edge of the frame. Submenus are opened by confirming with <ENTER>. Example:

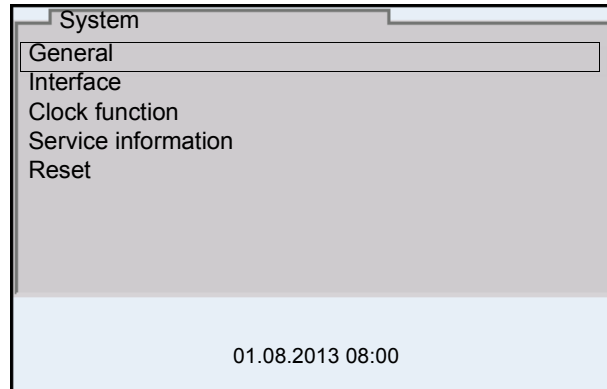

- Settings

Settings are indicated by a colon. The current setting is displayed on the right-hand side. The setting mode is opened with <ENTER>. Subsequently, the setting can be changed with <▲><▼> and <ENTER>. Example:

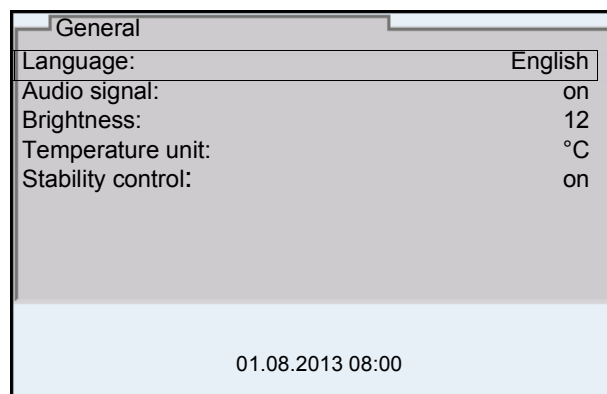

- Functions

Functions are designated by the name of the function. They are immediately carried out by confirming with <ENTER>. Example: Display the *Calibration record* function.

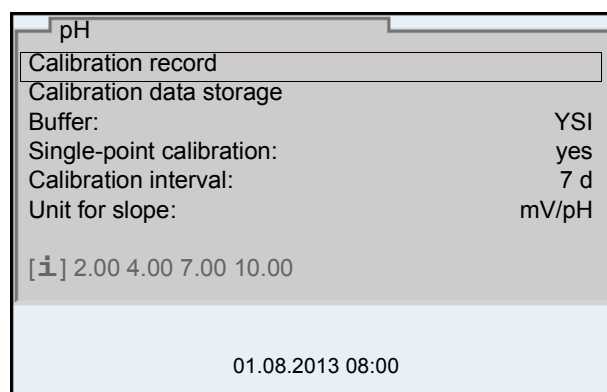

- Messages

Information is marked by the [i] symbol. It cannot be selected. Example:

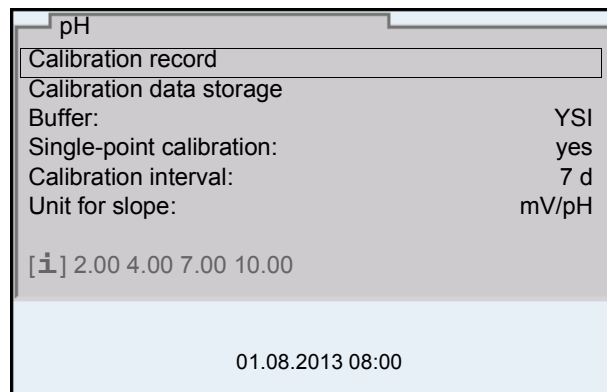

4.5.4 Example 1 on navigation: Setting the language

1. Press the **<On/Off>** key.
The measured value display appears.
The instrument is in the measuring mode.

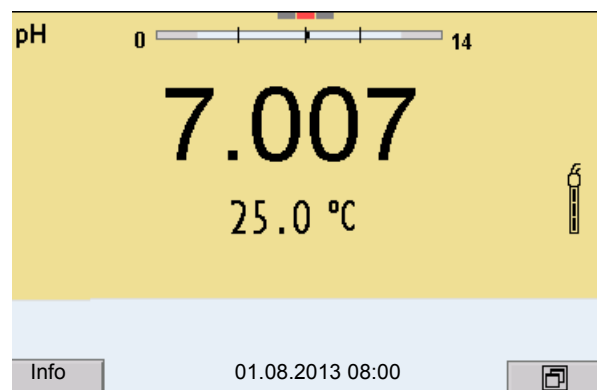

2. Open the *Storage & config* menu with **<ENTER_>**.
The instrument is in the setting mode.

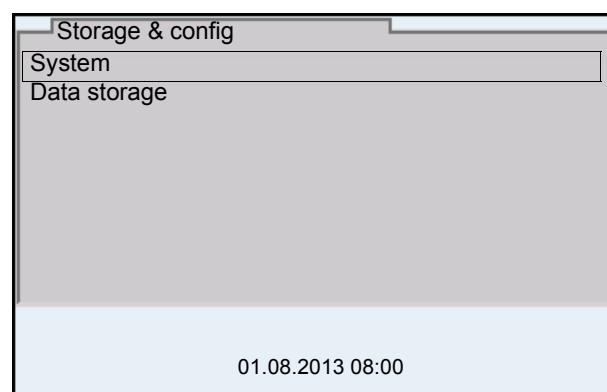

3. Select the *System* submenu with <▲><▼>. The current selection is displayed with a frame.
4. Open the *System* submenu with <ENTER>.

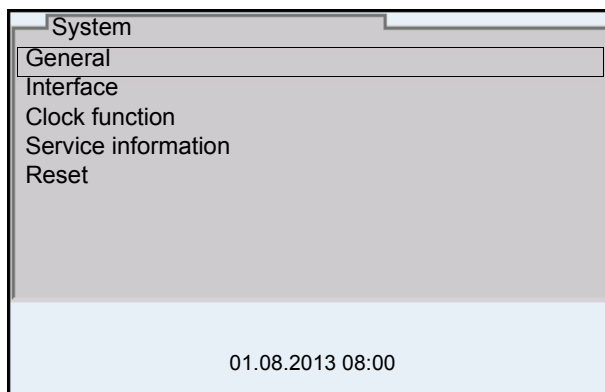

5. Select the *General* submenu with <▲><▼>. The current selection is displayed with a frame.
6. Open the *General* submenu with <ENTER>.

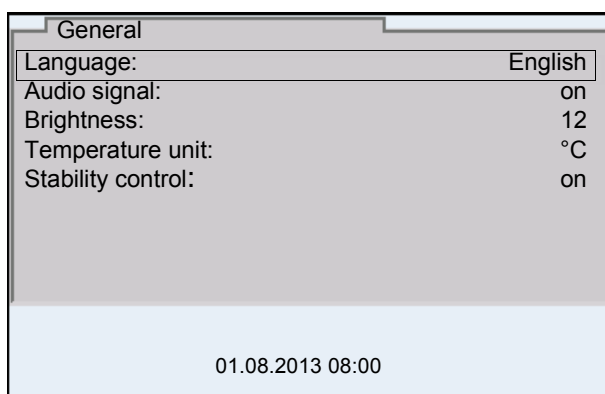

7. Open the setting mode for the *Language* with <ENTER>.

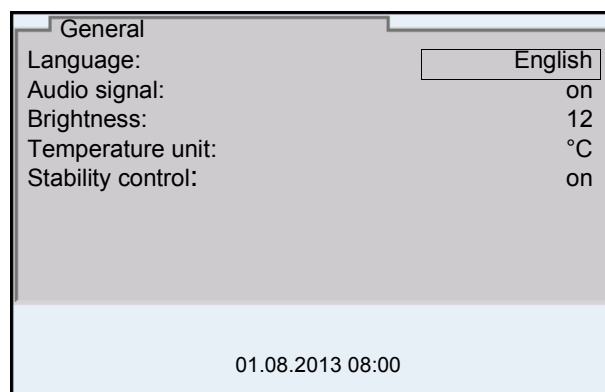

8. Select the required language with <▲><▼>.

9. Confirm the setting with **<ENTER>**.
The meter switches to the measuring mode.
The selected language is active.

4.5.5 Example 2 on navigation: Setting the date and time

The meter has a clock with a date function. The date and time are indicated in the status line of the measured value display.

When storing measured values and calibrating, the current date and time are automatically stored as well.

The correct setting of the date and time and date format is important for the following functions and displays:

- Current date and time
- Calibration date
- Identification of stored measured values.

Therefore, check the time at regular intervals.



The date and time are reset (to 01.01.2012 00:00 hours), if the following conditions are met:

- the supply voltage failed and
- the buffer batteries for the system clock are empty.

Setting the date, time and date format

The date format can be switched from the display of day, month, year (*dd.mm.yy*) to the display of month, day, year (*mm/dd/yy* or *mm.dd.yy*).

1. In the measured value display:
Open the *Storage & config* menu with **<ENTER_>**.
The instrument is in the setting mode.
2. Select and confirm the *System / Clock function* menu with **<▲><▼>** and **<ENTER>**.
The setting menu for the date and time opens up.

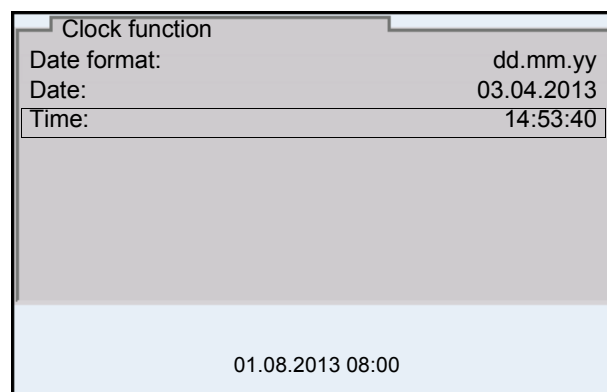

3. Select and confirm the *Time* menu with **<▲><▼>** and **<ENTER>**.
The hours are highlighted.

4. Change and confirm the setting with <▲><▼> and <ENTER>. The minutes are highlighted.
5. Change and confirm the setting with <▲><▼> and <ENTER>. The seconds are highlighted.
6. Change and confirm the setting with <▲><▼> and <ENTER>. The time is set.
7. If necessary, set the *Date* and *Date format*. The setting is made similarly to that of the time.
8. To make further settings, switch to the next higher menu level with <ESC>. or Switch to the measured value display with <M>. The instrument is in the measuring mode.

5 pH value

5.1 Measuring

5.1.1 Measuring the pH value



The sensor connection and the USB-B (device) interface are galvanically isolated. This facilitates interference-free measurements also in the following cases:

- Measurement in grounded test samples
- Measurement with several sensors connected to one MultiLab 4010-3 in one test sample

1. Connect the IDS pH sensor to the meter. The pH measuring window is displayed.
2. If necessary, select the measured parameter with **<M>**.
3. Adjust the temperature of the solutions and measure the current temperature if the measurement is made without a temperature sensor.
4. If necessary, calibrate or check the IDS pH sensor.
5. Immerse the IDS pH sensor in the test sample.



Stability control (AutoRead) & HOLD function

The stability control function (*AutoRead*) continually checks the stability of the measurement signal. The stability has a considerable impact on the reproducibility of measured values.

The measured parameter flashes on the display

- as soon as the measured value is outside the stability range
- when the automatic *Stability control* is switched off.

You can start the *Stability control* manually at any time, irrespective of the setting for automatic *Stability control* (see section 10.6.3 AUTOMATIC STABILITY CONTROL, page 97) in the *System* menu.

1. Freeze the measured value with **<AR>**. The [HOLD] status indicator is displayed. The HOLD function is active.



You can terminate the *Stability control* function and the HOLD function with **<AR>** or **<M>** at any time.

2. Using **<ENTER>**, activate the *Stability control* function manually. The [AR] status indicator appears while the measured value is assessed as not stable. A progress bar is displayed and the display of the measured parameter flashes. As soon as a measured value meets the stability criteria, it is frozen. The [HOLD][AR] status indicator is displayed, the progress bar disappears and the display of the measured parameter stops flashing. The current measurement data is output to the interface. Measurement data meeting the stability control criterion is marked by AR.



You can prematurely terminate the *Stability control* function manually with **<ENTER>** at any time. When the *Stability control* function is prematurely terminated, the current measurement data are output to the interface (PC, USB memory device or USB printer) without AutoRead info.

3. Using **<ENTER>**, start a further measurement with stability control.
or
Release the frozen measured value again with **<AR>** or **<M>**. The [AR] status display disappears. The display switches back to the previous indication.

Criteria for a stable measured value

The *Stability control* function checks whether the measured values are stable within the monitored time interval.

Measured parameter	Time interval	Stability in the time interval
pH value	15 seconds	Δ : Better than 0.01 pH
Temperature	15 seconds	Δ : Better than 0.5 °C

The minimum duration until a measured value is assessed as stable is the monitored time interval. The actual duration is mostly longer.

5.1.2 Measuring the temperature

For reproducible pH measurements, it is essential to measure the temperature of the test sample.

IDS sensors measure the temperature with a temperature sensor integrated in the IDS sensor.

When operating a sensor without integrated temperature sensor, e.g. via an IDS pH adapter, you have to measure and enter the temperature of the test sample first.

The display of the temperature indicates the active temperature measuring mode:

Temperature sensor	Resolution of the temp. display	Temp. measurement
Yes	0.1 °C	Automatic with temperature sensor
-	1 °C	Manual

5.2 pH calibration

5.2.1 Why calibrate?

pH electrodes age. This changes the zero point (asymmetry) and slope of the pH electrode. As a result, an inexact measured value is displayed. Calibration determines and stores the current values of the zero point and slope of the electrode.

Thus, you should calibrate at regular intervals.

5.2.2 When do you have to calibrate?

- Routinely within the framework of the company quality assurance
- When the calibration interval has expired

5.2.3 Carrying out automatic calibration (AutoCal)

Make sure that in the sensor menu, *Buffer* menu, the buffer set is correctly selected (see section 10.1.1 SETTINGS FOR PH MEASUREMENTS, page 84).

Use one to five buffer solutions of the selected buffer set in any order.

Below, calibration with YSI buffers (YSI) is described. When other buffer sets are used, other nominal buffer values are displayed. Apart from that, the procedure is identical.



If single-point calibration was set in the menu, the calibration procedure is automatically finished with the measurement of buffer solution 1 and the calibration record is displayed.

1. Connect the pH sensor to the meter.
The pH measuring window is displayed.
2. Keep the buffer solutions ready.
When measuring without temperature sensor:
Temper the buffer solutions or measure the current temperature.
3. Start the calibration with **<CAL>**.
The calibration display for the first buffer appears (voltage display).

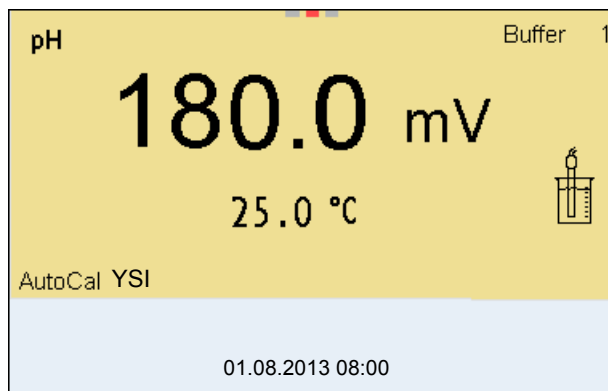

4. Thoroughly rinse the sensor with deionized water.
5. Immerse the sensor in the first buffer solution.
6. For measurements without temperature sensor (e.g. when using an IDS adapter):
Enter the temperature of the buffer with $\langle \blacktriangle \rangle \langle \blacktriangledown \rangle$.
7. Start the measurement with $\langle \text{ENTER} \rangle$.
The measured value is checked for stability (stability control).
The [AR] status indicator is displayed. The measured parameter flashes.

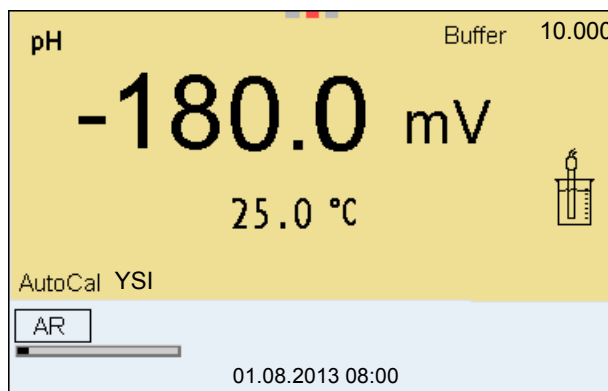

8. Wait for the end of the measurement with stability control or accept the calibration value with $\langle \text{ENTER} \rangle$.
The calibration display for the next buffer appears (voltage display).
9. If necessary, finish the calibration procedure as a single-point calibration with $\langle \text{M} \rangle$.
The calibration record is displayed.



For **single-point calibration**, the instrument uses the Nernst slope (-59.2 mV/pH at 25 °C) and determines the zero point of the IDS pH sensor.

Continuing with two-point calibration

10. Thoroughly rinse the sensor with deionized water.
11. Immerse the pH sensor in buffer solution 2.

12. When measuring without temperature sensor:
Enter the temperature of the buffer with <▲><▼>.
13. Start the measurement with <ENTER>.
The measured value is checked for stability (stability control).
The [AR] status indicator is displayed. The measured parameter flashes.

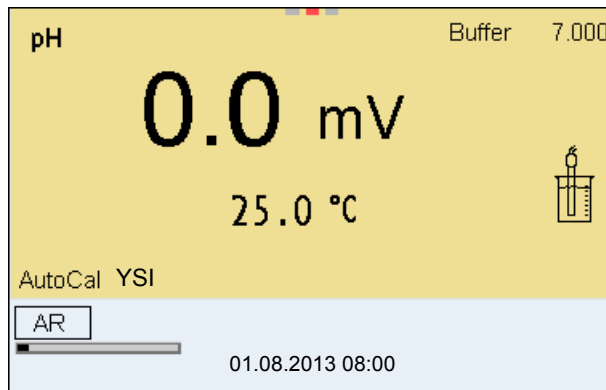

14. Wait for the measurement with stability control to be completed or terminate the stability control and take over the calibration value with <ENTER>.
The calibration display for the next buffer appears (voltage display).
15. If necessary, finish the calibration procedure as a two-point calibration with <M>.
The calibration record is displayed.

Continuing with three- to five-point calibration

16. Thoroughly rinse the sensor with deionized water.
17. Immerse the sensor in the next buffer solution.
18. When measuring without temperature sensor:
Enter the temperature of the buffer with <▲><▼>.
19. Start the measurement with <ENTER>.
The measured value is checked for stability (stability control).
The [AR] status indicator is displayed. The measured parameter flashes.

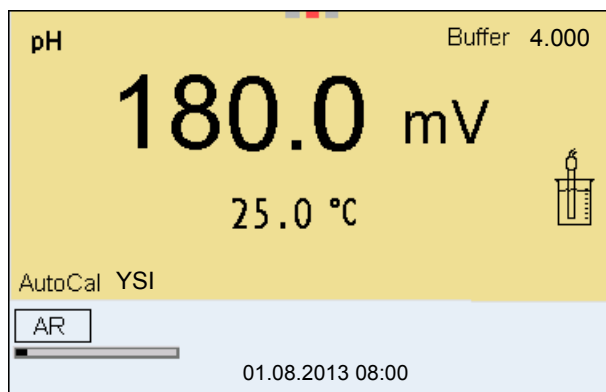

20. Wait for the measurement with stability control to be completed or terminate the stability control and take over the calibration value with **<ENTER>**.
The calibration display for the next buffer appears (voltage display).
21. If necessary, use **<M>** to finish the calibration.
The calibration record is displayed.
or
Switch to calibration with the next buffer with **<ENTER>**.



Calibration is automatically completed after the last buffer of a buffer set has been measured. Then the calibration record is displayed.

The calibration line is determined by linear regression.

5.2.4 Carrying out a manual calibration (ConCal)

Make sure that in the sensor menu, *Buffer* menu, the *ConCal* buffer set is correctly selected (see section 10.1.1 SETTINGS FOR PH MEASUREMENTS, page 84).

Use any one to five buffer solutions in ascending or descending order.



If single-point calibration was set in the menu, the calibration procedure is automatically finished with the measurement of buffer solution 1 and the calibration record is displayed.

1. Connect the pH sensor to the meter.
The pH measuring window is displayed.
2. Keep the buffer solutions ready.
When measuring without temperature sensor:
Temper the buffer solutions or measure the current temperature.
3. Start the calibration with **<CAL>**.
The calibration display for the first buffer appears (voltage display).

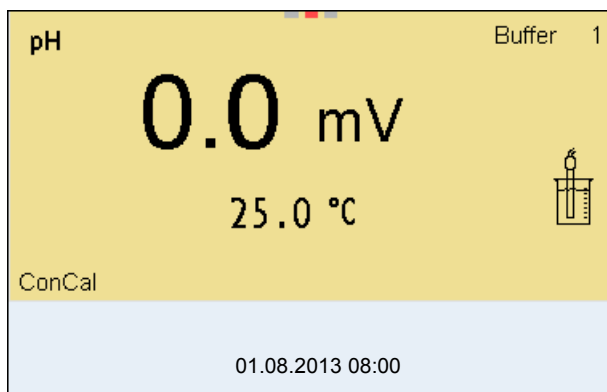

4. Thoroughly rinse the sensor with deionized water.
5. Immerse the pH sensor in buffer solution 1.
6. For measurements without temperature sensor (e.g. when using an IDS adapter):
Enter the temperature of the buffer with <▲><▼>.
7. Start the measurement with <ENTER>.
The measured value is checked for stability (stability control).
The [AR] status indicator is displayed. The measured parameter flashes.

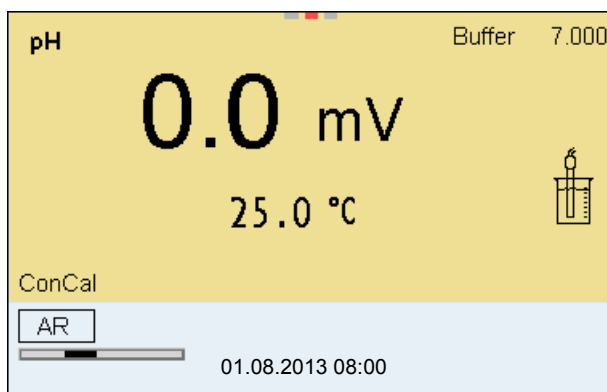

8. Wait for the measurement with stability control to be completed or terminate the stability control and take over the calibration value with <ENTER>.
The pH value of the buffer solution is displayed.

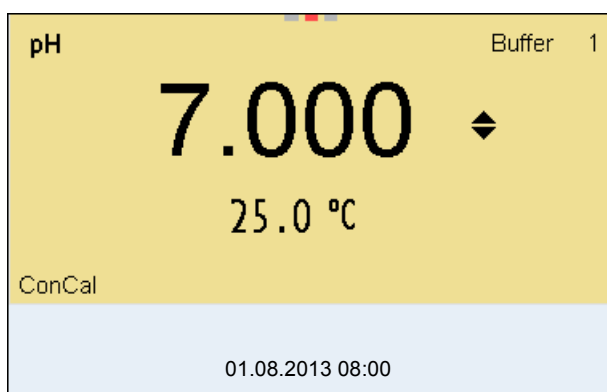

9. Set the nominal buffer value for the measured temperature with **<▲><▼>**.
10. Accept the calibration value with **<ENTER>**.
The calibration display for the next buffer appears (voltage display).
11. If necessary, finish the calibration procedure as a single-point calibration with **<M>**.
The calibration record is displayed.



For **single-point calibration**, the instrument uses the Nernst slope (-59.2 mV/pH at 25 °C) and determines the zero point of the IDS pH sensor.

Continuing with two-point calibration

12. Thoroughly rinse the sensor with deionized water.
13. Immerse the pH sensor in buffer solution 2.
14. When measuring without temperature sensor:
Enter the temperature of the buffer with **<▲><▼>**.
15. Start the measurement with **<ENTER>**.
The measured value is checked for stability (stability control).
The [AR] status indicator is displayed. The measured parameter flashes.
16. Wait for the measurement with stability control to be completed or terminate the stability control and take over the calibration value with **<ENTER>**.
The pH value of the buffer solution is displayed.

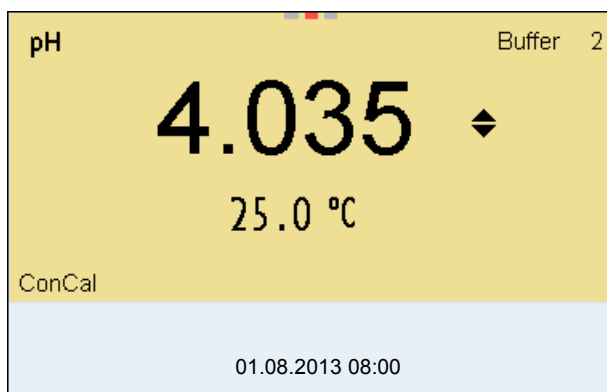

17. Set the nominal buffer value for the measured temperature with **<▲><▼>**.
18. Accept the calibration value with **<ENTER>**.
The calibration display for the next buffer appears (voltage display).
19. If necessary, finish the calibration procedure as a two-point calibration with **<M>**.
The calibration record is displayed.

Continuing with three- to five-point calibration

20. Thoroughly rinse the sensor with deionized water.
21. Immerse the sensor in the next buffer solution.
22. When measuring without temperature sensor:
Enter the temperature of the buffer with <▲><▼>.
23. Start the measurement with <ENTER>.
The measured value is checked for stability (stability control).
The [AR] status indicator is displayed. The measured parameter flashes.
24. Wait for the measurement with stability control to be completed or terminate the stability control and take over the calibration value with <ENTER>.
The pH value of the buffer solution is displayed.

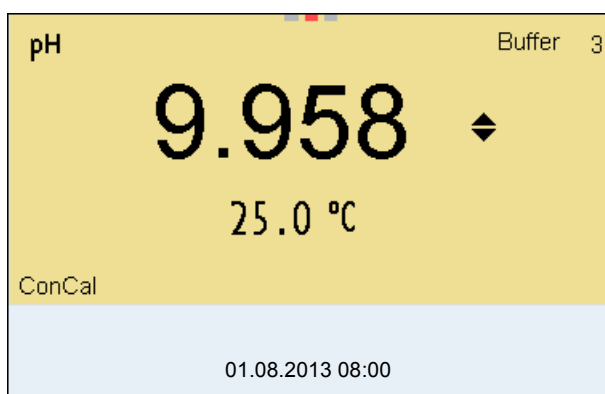

25. Set the nominal buffer value for the measured temperature with <▲><▼>.
26. Accept the calibration value with <ENTER>.
The calibration display for the next buffer appears (voltage display).
27. If necessary, use <M> to finish the calibration.
The calibration record is displayed.
or
Continue calibrating using the next buffer with <ENTER>.



After the fifth buffer has been measured the calibration is automatically finished. Then the calibration record is displayed.

The calibration line is determined by linear regression.

5.2.5 Calibration points

Calibration can be performed using one to five buffer solutions in any order (single-point to five-point calibration). The meter determines the following values and calculates the calibration line as follows:

Calibration	Determined values	Displayed calibration data
1-point	Asy	<ul style="list-style-type: none"> ● Zero point = Asy ● Slope = Nernst slope (-59.2 mV/pH at 25 °C)
2-point	Asy Slp.	<ul style="list-style-type: none"> ● Zero point = Asy ● Slope = Slp.
3-point to 5-point	Asy Slp.	<ul style="list-style-type: none"> ● Zero point = Asy ● Slope = Slp. <p>The calibration line is calculated by linear regression.</p>



You can display the slope in the units, mV/pH or % (see section 10.1.1 SETTINGS FOR PH MEASUREMENTS, page 84).

5.2.6 Calibration data



The calibration record is automatically transmitted to the interface after calibrating.

Displaying the calibration data





The calibration record of the last calibration is to be found under the menu item, *Calibration / Calibration record*. To open it in the measured value display, press the **<CAL_>** key.

The calibration records of the last 10 calibrations are to be found in the menu, *Calibration / Calibration data storage / Display*. To open the *Calibration* menu, press the **<ENTER>** key in the measured value display.

Menu item	Setting/function	Explanation
<i>Calibration / Calibration data storage / Display</i>	-	Displays the calibration records. Further options: <ul style="list-style-type: none"> ● Scroll through the calibration records with <◀><▶>. ● Using <PRT>, output the displayed calibration record to the USB-B (PC) interface or the USB-A (USB printer) interface. ● Using <PRT_>, output all calibration records to the USB-B (PC) interface or the USB-A (USB printer) interface. ● Quit the display with <ESC>. ● Switch directly to the measured value display with <M>.
<i>Calibration / Calibration data storage / Output to USB flash drive or printer</i>	-	Outputs the stored calibration data to the USB-A interface (USB memory device/USB printer)
<i>Calibration / Calibration data storage / Output to RS232/USB</i>	-	Outputs the stored calibration data to the USB-B interface (PC)

Calibration evaluation

After calibrating, the meter automatically evaluates the calibration. The zero point and slope are evaluated separately. The worse evaluation of both is taken into account. The evaluation appears on the display and in the calibration record.

Display	Calibration record	Zero point [mV]	Slope [mV/pH]
	+++	-15 ... +15	-60.5 ... -58.0
	++	-20 ... <-15 or >+15 ... +20	>-58.0 ... -57.0
	+	-25 ... <-20 or >+20 ... +25	-61.0 ... <-60.5 or >-57.0 ... -56.0
	-	-30 ... <-25 or >+25 ... +30	-62.0 ... <-61.0 or >-56.0 ... -50.0

Display	Calibration record	Zero point [mV]	Slope [mV/pH]
Clean the IDS sensor according to the sensor operating manual			
<i>Error</i>	<i>Error</i>	<-30 or >+30	<-62.0 or > -50,0
Error elimination (see section 14 WHAT TO DO IF..., page 115)			



For pH IDS sensors you can optionally enable a more finely graded calibration evaluation (QSC) (see section 5.2.8 QSC FUNCTION (SENSOR QUALITY CONTROL), page 40).

Calibration record

```

CALIBRATION pH
03.04.2013 07:43:33
4110
Ser. no. B092500013

YSI
Buffer 1                4.00
Buffer 2                7.00
Buffer 3                10.00
Voltage 1              184.0 mV
Voltage 2               3.0 mV
Voltage 3             -177.0 mV
Temperature 1          24.0 °C
Temperature 2          24.0 °C
Temperature 3          24.0 °C
Slope                  -60.2 mV/pH
Asymmetry              4.0 mV
Sensor                 +++
etc...

```

5.2.7 Continuous measurement control (CMC function)

The Continuous Measurement Control (CMC function) facilitates to evaluate the current measured value instantly and definitely.

After each successful calibration the scale of the pH measuring range is displayed in the measured value display. Here you can very clearly see whether or not the current measured value is in the calibrated part of the measuring range.

The following information is displayed:

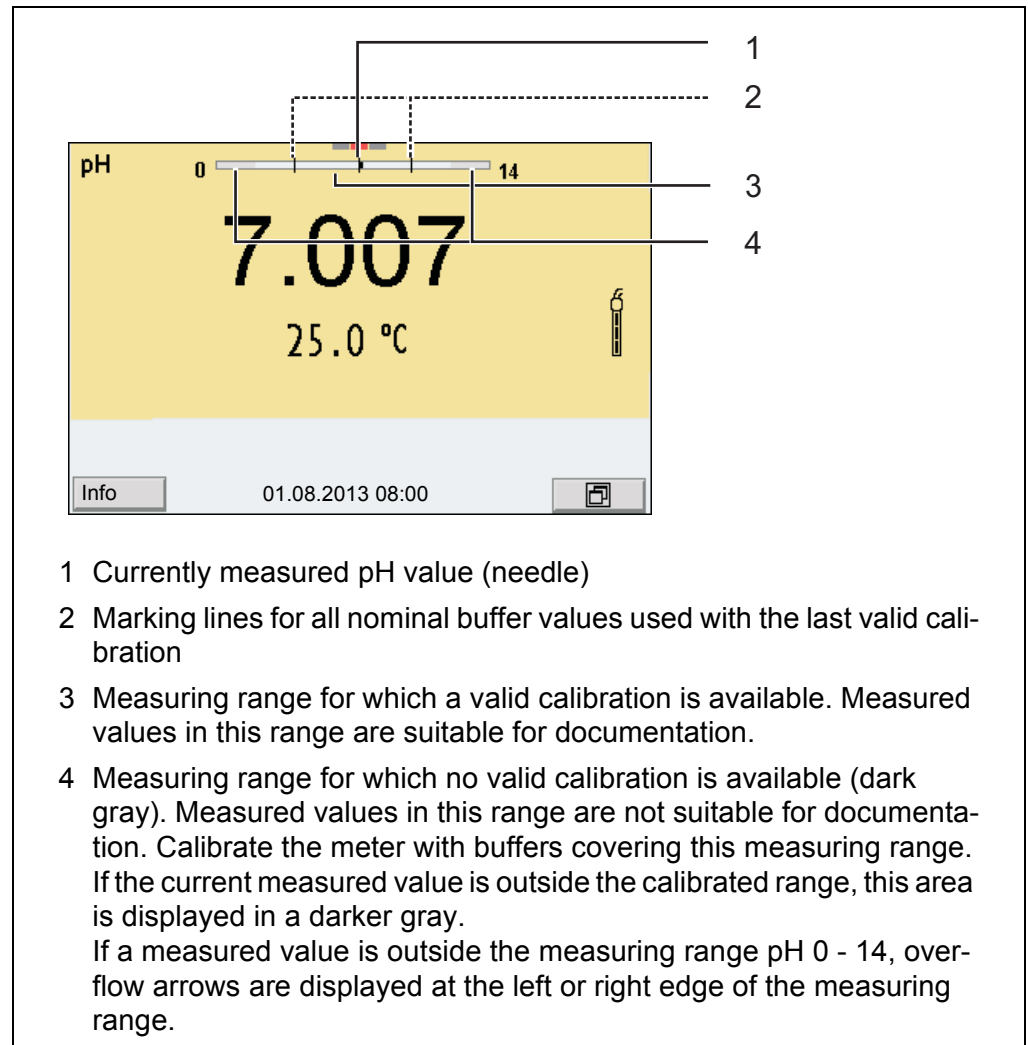

The limits of the calibrated range are determined by the buffers used for calibration:

Lower limit: Buffer with lowest pH value - 2 pH units
Upper limit: Buffer with highest pH value + 2 pH units

5.2.8 QSC function (sensor quality control)

General information on the QSC function

The QSC function (Quality Sensor Control) is a new sensor evaluation for digital IDS sensors. It evaluates the condition of an IDS pH sensor individually and with a very fine grading.

The QSC scale shows the current sensor evaluation with an indicator on the display.

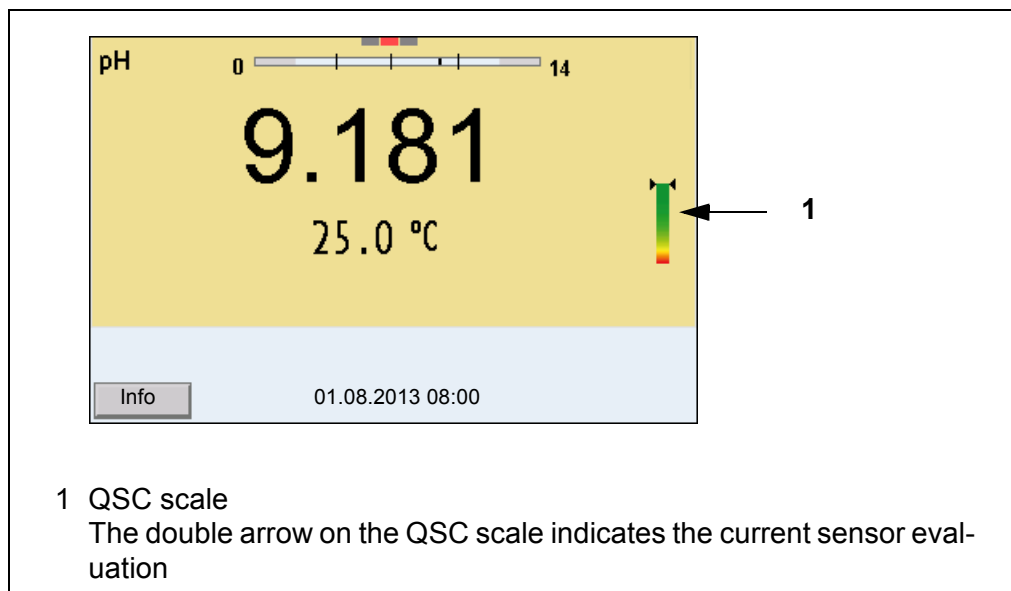

In the USB output the sensor evaluation is given as a percentage (1-100).

The finely graded sensor evaluation of the QSC function promptly calls your attention to changes of the sensor.

Thus you can do what is necessary to restore the optimum measuring quality (e.g. clean, calibrate or replace the sensor).

Sensor evaluation with / without QSC function

With QSC function	Without QSC function (sensor symbol)
Very fine grading of the sensor evaluation (100 grades)	Rough grading of the sensor evaluation (4 grades)
The reference value is individually determined for each sensor during the QSC initial calibration.	A theoretical reference value is used for all sensors
Low tolerances for zero point and slope when using QSC buffer solutions	Greater tolerances for zero point and slope when using commercial buffer sets
Additional QSC calibration required (with special QSC buffer set)	No additional calibration required

QSC calibration

The QSC function is enabled by once carrying out an additional three-point calibration with special QSC buffer solutions. It covers the measuring range of the sensor (pH 2 to pH 11). The QSC initial calibration determines the actual condition of the sensor and stores it as a reference in the sensor.

To meet the high requirements of a QSC initial calibration, the QSC initial calibration should optimally be carried out with the initial commissioning of the sensor.

Carry out the normal calibrations for your special measuring range with your usual standard solutions as previously done.



As soon as the QSC function was enabled for an IDS sensor, it is not possible to return to the sensor evaluation with the sensor symbol for this sensor.

Carrying out a QSC initial calibration

1. Open the menu for measurement settings with **<ENTER>**.
2. In the QSC menu, select *First calibration* with **<▲><▼>**.
The calibration display appears. *AutoCal QSC-Kit* is displayed as the buffer.
Exclusively use the QSC-Kit for the QSC calibration. If you use other buffers, you will have no valid QSC calibration.

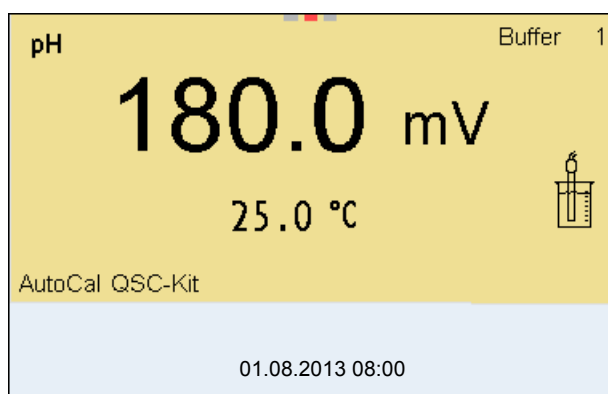

3. Calibration with the buffers of the QSC-Kit is done like a normal three-point calibration.
Follow the user guide.



Carry out the QSC initial calibration very carefully. It determines the reference value for the sensor. This reference value cannot be overwritten or reset.

As soon as the QSC function was enabled, it is not possible to return to the sensor evaluation with the sensor symbol.

4. As soon as the three-point calibration has been successfully carried out you can decide whether to accept or discard the calibration as the QSC initial calibration.

The QSC initial calibration is completed. The sensor is calibrated. If you want to calibrate with special buffers for your measurements, you can subsequently carry out a normal calibration with your buffers. The reference values determined with the QSC calibration are also used for the evaluation of normal calibrations. In the measured value display, the QSC scale of the QSC function is always displayed. A double arrow on the QSC scale indicates the current sen-

sensor evaluation.

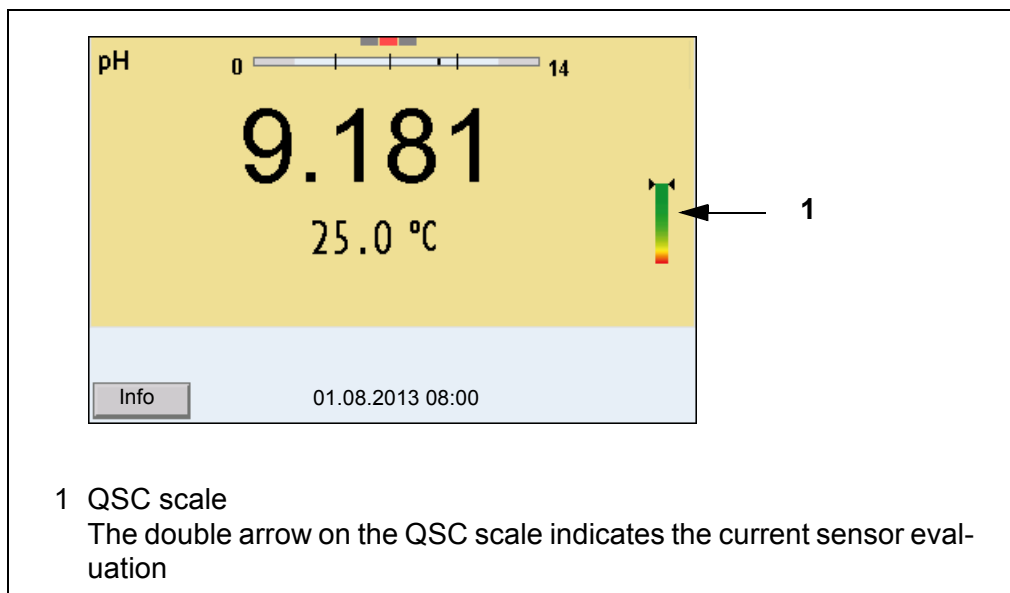

Carrying out a QSC control calibration

A QSC control calibration can, e.g. be useful if the sensor evaluation noticeably changed (after some normal calibrations).

You can carry out QSC control calibrations at greater intervals than normal calibrations.

1. Open the menu for measurement settings with **<ENTER>**.
2. In the QSC menu, select *Control calibration* with **<▲><▼>**.
The calibration display appears. *AutoCal QSC-Kit* is displayed as the buffer.
Exclusively use the QSC-Kit for the QSC calibration. If you use other buffers, you will have no valid QSC control calibration.
3. Follow the user guide.
The calibration is carried out like a normal three-point calibration. As soon as the three-point calibration has been successfully carried out you can decide whether to accept or discard the calibration as the QSC control calibration.

6 ORP voltage

6.1 Measuring

6.1.1 Measuring the ORP



The sensor connection and the USB-B (device) interface are galvanically isolated. This facilitates interference-free measurements also in the following cases:

- Measurement in grounded test samples
- Measurement with several sensors connected to one MultiLab 4010-3 in one test sample



IDS ORP sensors are not calibrated. However, you can check IDS ORP sensors using a test solution.

1. Connect the ORP sensor to the meter.
The ORP measuring window is displayed.
2. Adjust the temperature of the solutions and measure the current temperature if the measurement is made without a temperature sensor.
3. Check the meter with the ORP sensor.
4. Immerse the ORP sensor in the test sample.



Stability control (AutoRead) & HOLD function

The stability control function (*AutoRead*) continually checks the stability of the measurement signal. The stability has a considerable impact on the reproducibility of measured values.

The measured parameter flashes on the display

- as soon as the measured value is outside the stability range
- when the automatic *Stability control* is switched off.

You can start the *Stability control* manually at any time, irrespective of the setting for automatic *Stability control* (see section 10.6.3 AUTOMATIC STABILITY CONTROL, page 97) in the *System* menu.

1. Freeze the measured value with **<AR>**.
The [HOLD] status indicator is displayed.
The HOLD function is active.



You can terminate the *Stability control* function and the HOLD function with **<AR>** or **<M>** at any time.

2. Using **<ENTER>**, activate the *Stability control* function manually.
The [AR] status indicator appears while the measured value is assessed as not stable. A progress bar is displayed and the display of the measured parameter flashes.
As soon as a measured value meets the stability criteria, it is frozen. The [HOLD][AR] status indicator is displayed, the progress bar disappears and the display of the measured parameter stops flashing.
The current measurement data is output to the interface. Measurement data meeting the stability control criterion is marked by AR.



You can prematurely terminate the *Stability control* function manually with **<ENTER>** at any time. When the *Stability control* function is prematurely terminated, the current measurement data are output to the interface (PC, USB memory device or USB printer) without AutoRead info.

3. Using **<ENTER>**, start a further measurement with stability control.
or
Release the frozen measured value again with **<AR>** or **<M>**.
The [AR] status display disappears. The display switches back to the previous indication.

Criteria for a stable measured value

The *Stability control* function checks whether the measured values are stable within the monitored time interval.

Measured parameter	Time interval	Stability in the time interval
ORP	15 seconds	Δ : Better than 0.3 mV
Temperature	15 seconds	Δ : Better than 0.5 °C

The minimum duration until a measured value is assessed as stable is the monitored time interval. The actual duration is mostly longer.

6.1.2 Measuring the relative ORP

To measure the difference of the ORPs of two solutions, you have to define the ORP of one solution as the zero point first.



ORP electrodes can be used to determine the relative ORP.

1. Connect the ORP electrode to the meter.
2. Prepare the reference solution for the determination of the reference point.
3. Select the ΔU (mV display with **<M>**).
4. Immerse the ORP electrode in the reference solution.
5. Display the potential of the current zero point with **<CAL>**.
6. Press **<ENTER>** to measure the reference solution.
The measured value is checked for stability (automatic stability control). The display of the measured parameter flashes.
The measured potential is defined as the zero point.
or
Press **<M>** to terminate the display of the zero point.
7. Rinse the ORP electrode and immerse it in the test sample.
The measured value is checked for stability (automatic stability control). The display of the measured parameter flashes.
8. Wait for a stable measured value.
The display of the measured parameter no longer flashes.



AutoRead

The *Stability control* function checks whether the measured values are stable within the monitored time interval.

Measured parameter	Time interval	Stability in the time interval
ORP	15 seconds	Δ : better than 0.3 mV
Temperature	15 seconds	Δ : better than 0.5 °C

The minimum duration until a measured value is assessed as stable is the monitored time interval. The actual duration is mostly longer.

6.1.3 Measuring the temperature

For reproducible ORP measurements, it is essential to measure the temperature of the test sample.

When operating a sensor without integrated temperature sensor, you first have to measure and enter the temperature of the sample.

The measuring instrument recognizes whether a suitable sensor is connected and automatically switches on the temperature measurement.

The display of the temperature indicates the active temperature measuring mode:

Temperature sensor	Resolution of the temp. display	Temp. measurement
Yes	0.1 °C	Automatic with temperature sensor
-	1 °C	Manual

6.2 ORP calibration



ORP electrodes are not calibrated. You can, however, check ORP electrodes by measuring the ORP of a test solution and comparing the value with the nominal value.

7 Ion concentration

7.1 Measuring

7.1.1 Measuring the ion concentration



The sensor connection and the USB-B (device) interface are galvanically isolated. This facilitates interference-free measurements also in the following cases:

- Measurement in grounded test samples
- Measurement with several sensors connected to one MultiLab 4010-3 in one test sample



Incorrect calibration of ion selective electrodes will result in incorrect measured values. Calibrate regularly before measuring.



For precise ISE measurements the temperature difference between measurement and calibration should not be greater than 2 K. Therefore, adjust the temperature of the standard and measuring solutions accordingly. If the temperature difference is greater the *[TpErr]* warning appears in the measured value display.

1. Connect the ISE combination electrode to the meter with the aid of an ADA 94/IDS adapter.
The pH/ISE measuring window is displayed.
2. In the measured value display, select the ISE measuring window with **<▲>** **<▼>** and **<M>**.
3. If necessary, change the ion type in the *ISE setup/Ion type* menu.
4. If necessary, measure the temperature of the test sample with a thermometer.
5. Calibrate or check the meter with the electrode.



While no valid calibration is available, e.g. in the delivery condition, "Error" appears in the measured value display.

6. Immerse the electrode in the test sample.

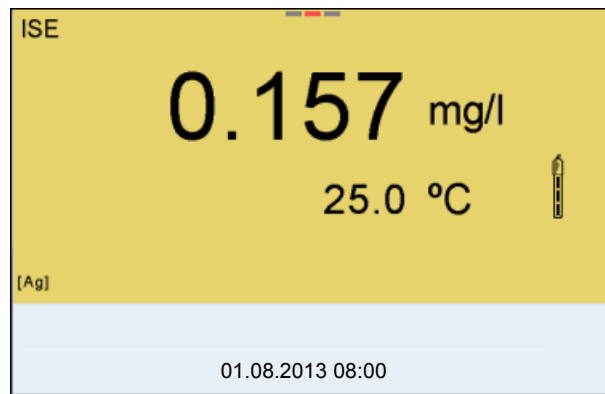

Stability control (AutoRead) & HOLD function

The stability control function (*AutoRead*) continually checks the stability of the measurement signal. The stability has a considerable impact on the reproducibility of measured values.

The measured parameter flashes on the display

- as soon as the measured value is outside the stability range
- when the automatic *Stability control* is switched off.

You can activate or switch off the automatic *Stability control* function (see section 10.6.3 AUTOMATIC STABILITY CONTROL, page 97).

1. Freeze the measured value with **<AR>**.
The [HOLD] status indicator is displayed.
The HOLD function is active.



You can terminate the *Stability control* function and the HOLD function with **<AR>** or **<M>** at any time.

2. Using **<ENTER>**, activate the *Stability control* function manually. The [AR] status indicator appears while the measured value is assessed as not stable. A progress bar is displayed and the display of the measured parameter flashes. The [HOLD][AR] status indicator appears as soon as a stable measured value is recognized. The progress bar disappears and the display of the measured parameter stops flashing. The current measurement data is output to the interface. Measurement data meeting the stability control criterion is marked by AR.



You can prematurely terminate the *Stability control* function manually with **<ENTER>** at any time. If the *Stability control* function is prematurely terminated, the current measurement data are output to the interface without the AutoRead info.

3. Using **<ENTER>**, start a further measurement with stability control.
or
Release the frozen measured value again with **<AR>** or **<M>**.
The [AR] status display disappears. The display switches back to the previous indication.

Criteria The AutoRead criteria affect the reproducibility of the measured values. The following criteria can be adjusted:

- *high*: highest reproducibility
- *medium*: medium reproducibility
- *low*: lowest reproducibility



Increasing reproducibility also causes the response time to increase until a measured value is evaluated as stable.

7.1.2 Measuring the temperature

For reproducible ion-selective measurements, it is essential to measure the temperature of the test sample.

You have the following options to measure the temperature:

- Measurement by an external temperature sensor.
- Manual determination and input of the temperature.

The measuring instrument recognizes whether a suitable sensor is connected and automatically switches on the temperature measurement.

The display of the temperature indicates the active temperature measuring mode:

Temperature sensor	Resolution of the temp. display	Temp. measurement
yes	0.1 °C	Automatic with temperature sensor
-	1 °C	Manual

If you wish to measure (or calibrate) without temperature sensor, proceed as follows:

1. Measure the current temperature of the test sample.
2. Set the temperature value with **<▲><▼>**.
or
In the **<ENTER>/ISE/Man. temperature** menu, set the temperature value with **<▲><▼>**.

7.2 Calibration

7.2.1 Why calibrate?

Ion-selective electrodes age and are temperature-dependent. This changes the slope. As a result, an inexact measured value is displayed. Calibration determines the calibration line of the electrode and stores this value in the meter.

Thus, you should calibrate before each measurement and at regular intervals.

7.2.2 When to calibrate?

- Before any measurement if possible
- After connecting another ISE electrode

7.2.3 Calibration (ISE Cal)

ISE Cal is the conventional **two-point to seven-point calibration procedure** that uses 2 to 7 freely selectable standard solutions. The concentration expected for the measurement determines the concentration of the calibration standards.

1. Connect the ISE combination electrode to the meter.
The pH/mV/ISE measuring window is displayed.
2. Keep the standard solutions ready.
3. If necessary, measure the temperature of the standard solutions with a thermometer.
4. In the measured value display, select the ISE measuring window with **<▲>** **<▼>** and **<M>**.
5. If necessary, change the ion type in the *ISE setup/Ion type* menu.
6. If necessary, change the unit of the measurement result and calibration standards in the *ISE setup/Unit* menu.
7. Start the calibration with **<CAL>**.
The calibration display appears.

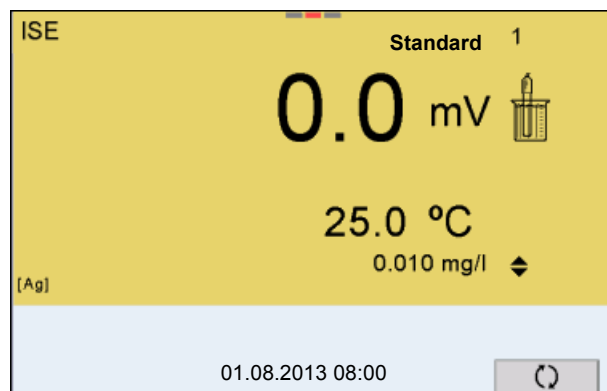

8. Thoroughly rinse the electrode with distilled water.

9. Immerse the electrode in standard solution 1.
10. When calibrating without temperature sensor:
 - Measure the temperature of the standard solution using a thermometer.
 - Use <F4>/[↑] to select the setting of the temperature.
 - Use <▲> <▼> to set the temperature.
 - Use <F4>/[↑] to select the setting of the concentration.
11. Set the concentration of the standard solution with <▲> <▼> and press <ENTER>.

The standard solution is measured.
The measured value is checked for stability (AutoRead).

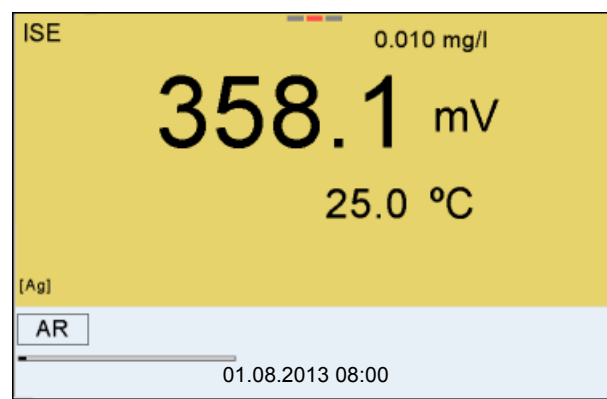

12. Wait for the end of the AutoRead measurement or accept the calibration value with <ENTER>.

The calibration display for the next standard solution appears.

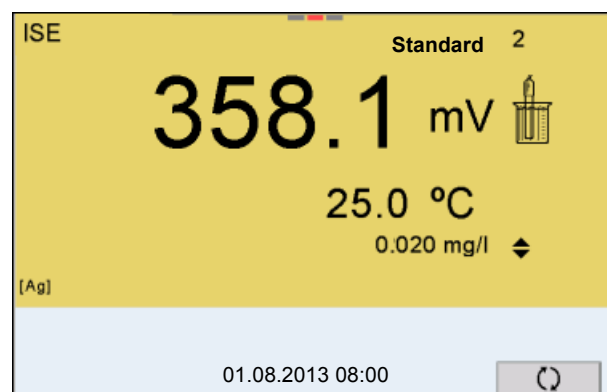

Continuing with two-point calibration

13. Thoroughly rinse the electrode with distilled water.
14. Immerse the electrode in standard solution 2.

15. When calibrating without temperature sensor:
- Measure the temperature of the standard solution using a thermometer.
 - Use <F4>/[\updownarrow] to select the setting of the temperature.
 - Use <▲> <▼> to set the temperature.
 - Use <F4>/[\updownarrow] to select the setting of the concentration.
16. Set the concentration of the standard solution with <▲> <▼> and press <ENTER>.
The standard solution is measured.
The measured value is checked for stability (AutoRead).

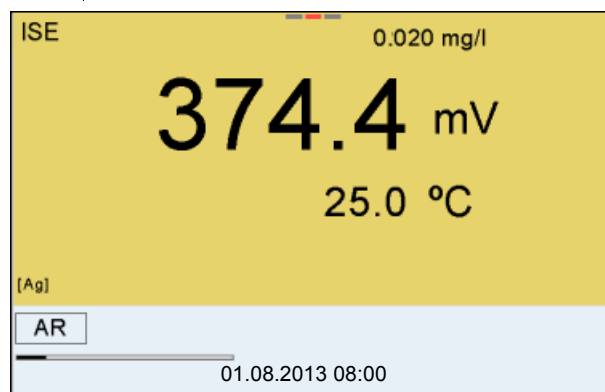

17. Wait for the end of the AutoRead measurement or accept the calibration value with <ENTER>.
The calibration display for the next standard solution appears.

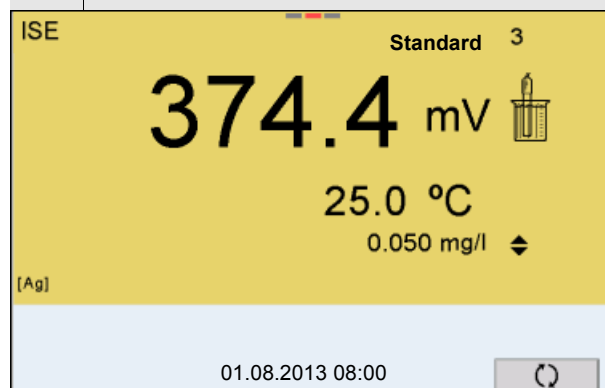

18. Press <ENTER> to continue with three-point calibration.
or
Finish the calibration procedure as a two-point calibration with <M>.
The new calibration values are displayed.

Continuing with three- to seven-point calibration

Repeat the steps 8 to 13 in the same way with the third and further standard solutions as necessary. The new calibration values are displayed after the last calibration step was completed.



Based on the calibration data, the calibration curve is determined in sections, according to the Nernst equation modified by Nikolski.

7.2.4 Calibration standards

Use two to seven different standard solutions. The standard solutions have to be selected in either increasing or decreasing order.



Select the unit of the standard solution and measurement result in the *ISE setup/Unit* menu.

Standard solution (Std 1 - 7)	Values
Unit [mg/l]	0.010 ... 500,000
Unit [mol/l]	0.100 ... 5,000 µmol/l 10.00 ... 5,000 mmol/l
Unit [mg/kg]	0.010 ... 500,000
Unit [ppm]	0.010 ... 500,000
Unit [%]	0.001 ... 50,000



The measurement precision is also dependent on the selected standard solutions. Therefore, the selected standard solutions should cover the value range expected of the subsequent concentration measurement.

If the measured electrode potential is outside the calibrated range, the *[ISEErr]* warning is displayed.

7.2.5 Calibration data



The calibration record is automatically transmitted to the interface after calibrating.

Displaying the calibration data

The calibration record of the last calibration is to be found under the menu item, *Calibration / Calibration record*. To open it in the measured value display, press the **<CAL_>** key.

The calibration records of the last 10 calibrations are to be found in the menu, *Calibration / Calibration data storage / Display*. To open the *Calibration* menu, press the **<ENTER>** key in the measured value display.

Menu item	Setting/function	Explanation
<i>Calibration / Calibration data storage / Display</i>	-	Displays the calibration records. Further options: <ul style="list-style-type: none"> ● Scroll through the calibration records with <◀><▶>. ● Using <PRT>, output the displayed calibration record to the USB-B (PC) interface or the USB-A (USB printer) interface. ● Using <PRT_>, output all calibration records to the USB-B (PC) interface or the USB-A (USB printer) interface. ● Quit the display with <ESC>. ● Switch directly to the measured value display with <M>.
<i>Calibration / Calibration data storage / Output to USB flash drive or printer</i>	-	Outputs the stored calibration data to the USB-A interface (USB memory device/USB printer)
<i>Calibration / Calibration data storage / Output to RS232/USB</i>	-	Outputs the stored calibration data to the USB-B interface (PC)

Calibration evaluation

After calibrating, the meter automatically evaluates the calibration.

Display	Calibration record	Magnitude of the slope [mV]
	+++	50.0 ... 70.0 or 25.0 ... 35.0
<i>Error</i> Error elimination (see section 13 WHAT TO DO IF..., page 89)	<i>Error</i>	< 50 or > 70 or < 25 or > 35

**Calibration record
(example)**

```
MultiLab 4010-3
Ser. no. 12345678

CALIBRATION ISE
18.01.2013 08:09:10

Sensor
Ser. no. 12345678

Standard 1          0.010 mg/l
Standard 2          0.020 mg/l
Voltage 1           38.5 mV
Voltage 2           58.0 mV
Temperature 1       24.0 øC
Temperature 2       24.0 øC
Ion type            Ag
Slope               54.1 mV
Sensor              +++
```

7.3 Selecting the measuring method

The following methods are supported:

- *Standard addition*
- *Standard subtraction*
- *Sample addition*
- *Sample subtraction*
- *Blank value addition*

1. Connect the ISE combination electrode to the meter.
The pH/ISE measuring window is displayed.
2. If necessary, select the ISE display with **<M>**.
3. If necessary, measure the temperature of the test sample with a thermometer.
4. Open the ISE menu with **<ENTER>**.
5. Thoroughly rinse the electrode with distilled water.
6. Adjust the temperature of the standard solutions.
7. Select *Method* with **<▲>** **<▼>** and confirm with **<ENTER>**.
8. Select a method with **<▲>** **<▼>** and confirm with **<ENTER>**.

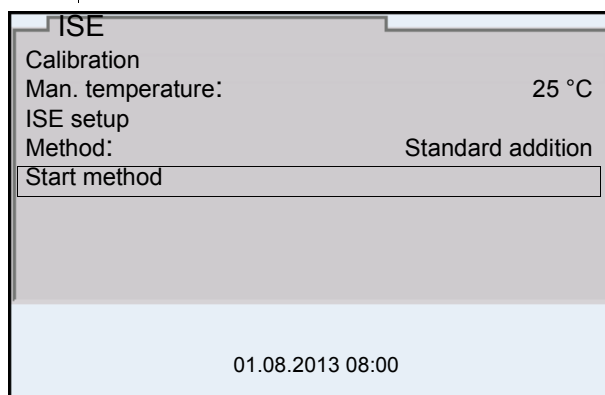

9. Select *Start method* with **<▲>** **<▼>** and confirm with **<ENTER>**.
Measurement with the selected method begins (see section 7.3.1 STANDARD ADDITION, page 57 ... section 7.3.5 STANDARD ADDITION WITH BLANK VALUE CORRECTION (BLANK VALUE ADDITION), page 66).

7.3.1 Standard addition

In the "Standard addition" procedure, a known amount of standard solution is added to the sample.

The ion concentration in the sample is calculated from the change in potential.

1. Select the measuring method (see section 7.3 SELECTING THE MEASURING METHOD, page 56).
2. Prepare two standard calibration solutions.
3. Perform a two-point calibration according to user guidance.
4. The calibration record is displayed as soon as a stable value is achieved for the second standard calibration solution.

CALIBRATION		
ADA 94/IDS BNC		
B092500013		
01.08.2013 08:00		
#1 0.010 mg/l	20.2 mV	25.0 °C
#2 0.020 mg/l	79.2 mV	25.0 °C
Slp.: 54.1 mV		
Sensor +++ (Ion type: Ag)		
01.08.2013 08:00		

Measuring

5. Start the measurement with <F1>/[continue].
An entry window appears.

Standard addition	
<i>i</i> Immerse sensor in sample	
Sample volume	100.0 ml
ISA/TISAB vol.	1.0 ml
continue	
01.08.2013 08:00	

6. Prepare the sample.
7. If necessary, add the ISA/TISAB solution to the sample.
8. Thoroughly rinse the electrode with deionized water.
9. Immerse the electrode in the sample.
10. Using <▲> <▼> and <ENTER>, select the values for the volume of the sample (*Sample volume*) and the volume of the ISA/TISAB solution (*ISA/TISAB vol.*).

11. Select *continue* with <▲> <▼> and start the measurement with <ENTER>. When the measurement is finished an entry window appears.



12. Add the standard solution to the sample.
13. Using <▲> <▼> and <ENTER>, enter the values for the volume of the standard solution (*Std. volume*) and concentration of the standard solution (*Std. conc.*).
14. Select *continue* with <▲> <▼> and start the measurement with <ENTER>. The measurement result is displayed when the measurement is completed.

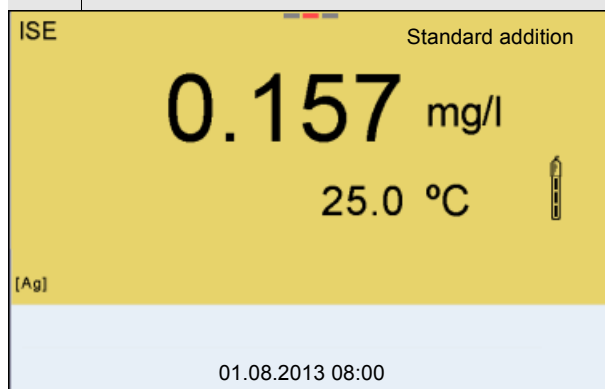

15. If necessary, start measuring further samples with <ENTER>. Repeat steps 6 - 14 for all samples.
16. Terminate the measuring method with <M>. A safety query appears.
17. Select *yes* with <▲> <▼>.
18. Confirm *yes* with <ENTER>. Measurement with the selected method is completed.

7.3.2 Standard subtraction

In the "Standard Subtraction" procedure, a known amount of standard solution is added to the sample (as complexing agent or precipitating agent) and, thus, the ion concentration lowered.

The ion concentration in the sample is calculated from the change in potential.

1. Select the measuring method (see section 7.3 SELECTING THE MEASURING METHOD, page 56).

Calibration

2. Prepare two standard calibration solutions.
3. Perform a two-point calibration according to user guidance.
4. The calibration record is displayed as soon as a stable value is achieved for the second standard calibration solution.

CALIBRATION		
ADA 94/IDS BNC		
B092500013		
01.08.2013 08:00		
#1 0.010 mg/l	20.2 mV	25.0 °C
#2 0.020 mg/l	79.2 mV	25.0 °C
Slp.: 54.1 mV		
Sensor +++ (Ion type: Ag)		
01.08.2013 08:00		

Measuring

5. Start the measurement with <F1>/[continue].
An entry window appears.

Standard subtraction	
i Immerse sensor in sample	
Sample volume	100.0 ml
ISA/TISAB vol.	1.0 ml
continue	
01.08.2013 08:00	

6. Prepare the sample.
7. If necessary, add the ISA/TISAB solution to the sample.
8. Thoroughly rinse the electrode with deionized water.

9. Immerse the electrode in the sample.
10. Using **<▲>** **<▼>** and **<ENTER>**, select the values for the volume of the sample (*Sample volume*) and the volume of the ISA/TISAB solution (*ISA/TISAB vol.*).
11. Select *continue* with **<▲>** **<▼>** and start the measurement with **<ENTER>**.
When the measurement is finished an entry window appears.

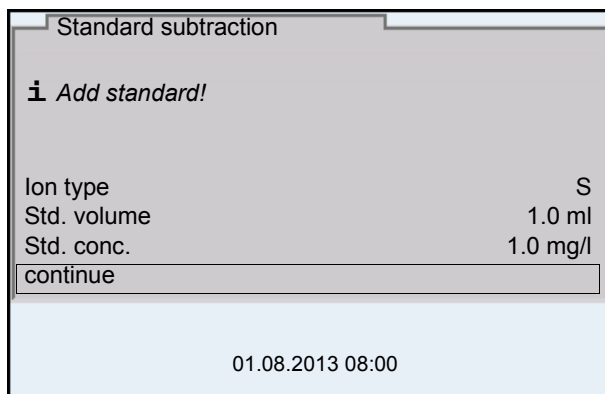

12. Add the standard (complexing agent or precipitating agent) to the sample.
13. Using **<▲>** **<▼>** and **<ENTER>**, enter the values for the volume of the standard solution (*Std. volume*) and concentration of the standard solution (*Std. conc.*).
14. If necessary, set the ion type for the ion in the standard (*Ion type*) with **<▲>** **<▼>** and **<ENTER>**.
On selection of the ion type that can be defined (ION):
Using **<▲>** **<▼>** and **<ENTER>**, set the valency (*Valency*) and molar weight (*Molar mass*) for the ion in the standard solution.
15. Select *continue* with **<▲>** **<▼>** and start the measurement with **<ENTER>**.
The measurement result is displayed when the measurement is completed.

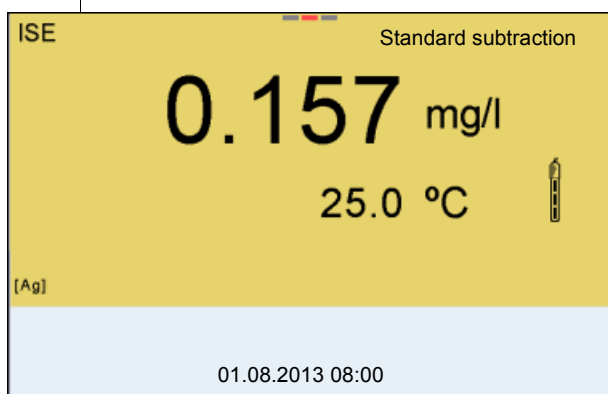

16. If necessary, start measuring further samples with **<ENTER>**.
Repeat steps 6 - 13 for all samples.

-
- | | |
|-----|---|
| 17. | Terminate the measuring method with <M> .
A safety query appears. |
| 18. | Select yes with <▲> <▼> . |
| 19. | Confirm yes with <ENTER> .
Measurement with the selected method is completed. |

7.3.3 Sample addition

In the "Sample addition" procedure, a known amount of sample is added to the standard solution.

The ion concentration in the sample is calculated from the change in potential.

1. Select the measuring method (see section 7.3 SELECTING THE MEASURING METHOD, page 56).

Calibration

2. Prepare two standard calibration solutions.
3. Perform a two-point calibration according to user guidance.
4. The calibration record is displayed as soon as a stable value is achieved for the second standard calibration solution.

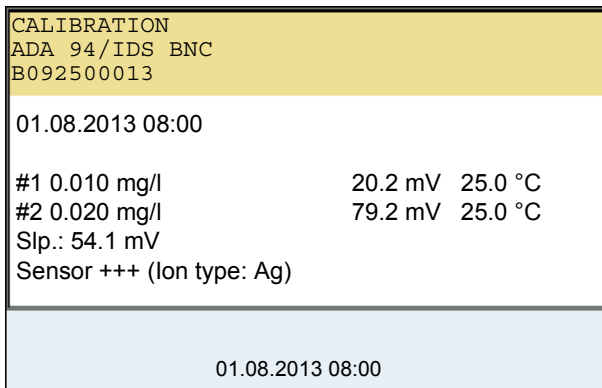

Measuring

5. Start the measurement with <F1>/[continue]. An entry window appears.

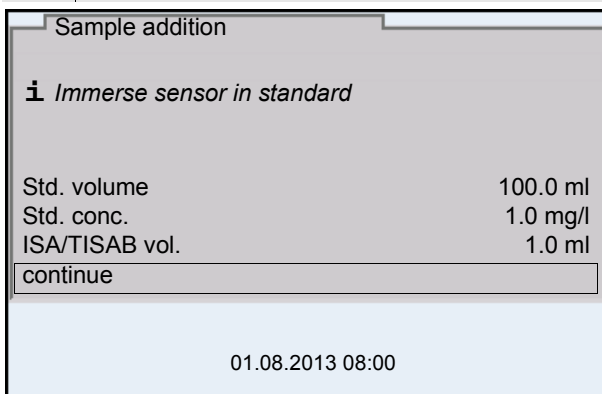

6. Prepare the standard solution.
7. If necessary, add the ISA/TISAB solution to the standard solution.
8. Thoroughly rinse the electrode with deionized water.
9. Immerse the electrode in the standard.

10. Using **<▲>** **<▼>** and **<ENTER>**, enter the values for the volume of the standard solution (*Std. volume*), the concentration of the standard solution (*Std. conc.*) and the volume of the ISA/TISAB solution (*ISA/TISAB vol.*).
11. Select *continue* with **<▲>** **<▼>** and start the measurement with **<ENTER>**.
When the measurement is finished an entry window appears.

12. Add the sample to the standard solution.
13. Using **<▲>** **<▼>** and **<ENTER>**, enter the value for the volume of the sample (*Sample volume*).
14. Select *continue* with **<▲>** **<▼>** and start the measurement with **<ENTER>**.
The measurement result is displayed when the measurement is completed.

15. If necessary, start measuring further samples with **<ENTER>**.
Repeat steps 6 - 12 for all samples.
16. Terminate the measuring method with **<M>**.
A safety query appears.
17. Select *yes* with **<▲>** **<▼>**.
18. Confirm *yes* with **<ENTER>**.
Measurement with the selected method is completed.

7.3.4 Sample subtraction

With the "Sample subtraction" procedure, a known amount of sample is added to the standard solution (complexing agent or precipitating agent).

The ion concentration in the sample is calculated from the change in potential. The sample subtraction is one method for the indirect determination of ions. It is used for the determination of ions for which no direct determination is possible.

1. Select the measuring method (see section 7.3 SELECTING THE MEASURING METHOD, page 56).

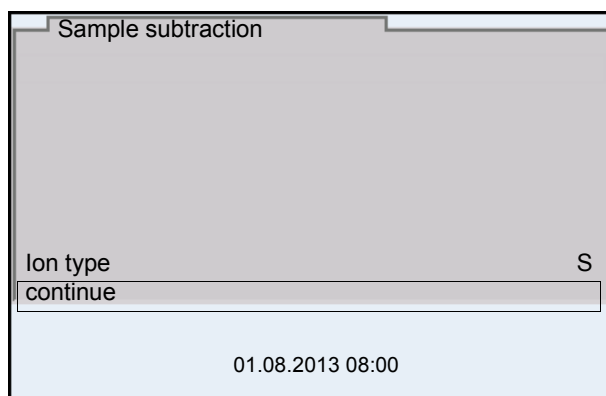

2. If necessary, set the ion type for the ion in the standard (*Ion type*) with **<▲>** **<▼>** and **<ENTER>**.
On selection of the ion type that can be defined (ION):
Using **<▲>** **<▼>** and **<ENTER>**, set the valence (*Valency*) and molar weight (*Molar mass*) for the ion in the standard solution.
3. Select *continue* with **<▲>** **<▼>** and confirm with **<ENTER>**.

Calibration

4. Prepare two standard calibration solutions.
5. Perform a two-point calibration according to user guidance.
6. The calibration record is displayed as soon as a stable value is achieved for the second standard calibration solution.

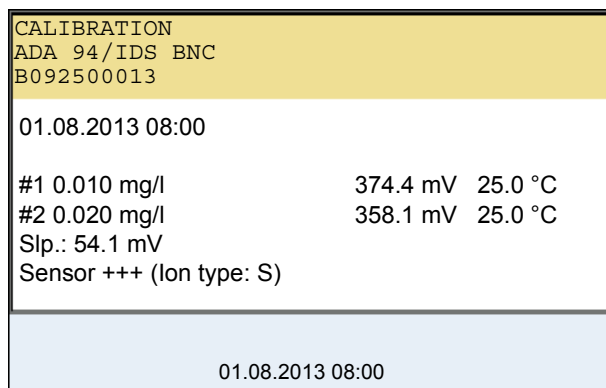

Measuring

7. Start the measurement with **<F1>** *continue*.
An entry window appears.

Sample subtraction	
i <i>Immerse sensor in standard</i>	
Std. volume	100.0 ml
Std. conc.	1.0 mg/l
ISA/TISAB vol.	1.0 ml
continue	
01.08.2013 08:00	

8. Prepare the standard solution.
9. If necessary, add the ISA/TISAB solution to the standard solution.
10. Thoroughly rinse the electrode with deionized water.
11. Immerse the electrode in the standard solution (complexing agent or precipitating agent).
12. Using **<▲>** **<▼>** and **<ENTER>**, enter the values for the volume of the standard solution (*Std. volume*), the concentration of the standard solution (*Std. conc.*) and the volume of the ISA/TISAB solution (*ISA/TISAB vol.*).
13. Select *continue* with **<▲>** **<▼>** and start the measurement with **<ENTER>**.
When the measurement is finished an entry window appears.

Sample subtraction	
i <i>Add sample!</i>	
Sample volume	1.0 ml
continue	
01.08.2013 08:00	

14. Add the sample to the standard (complexing agent or precipitating agent).
15. Using **<▲>** **<▼>** and **<ENTER>**, enter the value for the volume of the sample (*Sample volume*).
16. Select *continue* with **<▲>** **<▼>** and start the measurement with **<ENTER>**.
The measurement result is displayed when the measurement is completed.

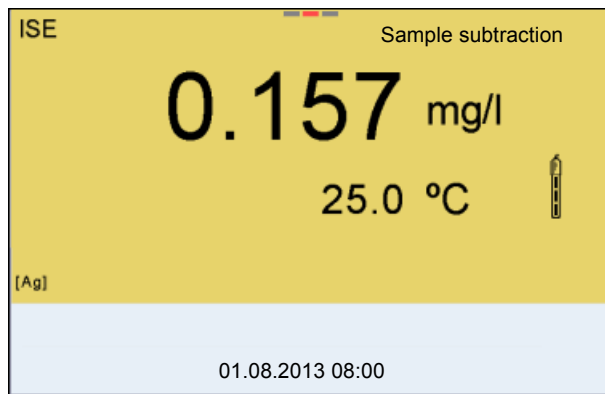

- | | |
|-----|--|
| 17. | If necessary, start measuring further samples with <ENTER> . Repeat steps 8 - 16 for all samples. |
| 18. | Terminate the measuring method with <M> . A safety query appears. |
| 19. | Select yes with <▲> <▼> . |
| 20. | Confirm yes with <ENTER> . Measurement with the selected method is completed. |

7.3.5 Standard addition with blank value correction (*Blank value addition*)

In the "Standard addition with blank value correction" procedure, a known amount of standard solution is added to the sample in two steps.

With the first addition, the ion concentration is raised to the linear range of the electrode characteristic curve.

The second addition is equivalent to the standard addition. The ion concentration in the sample is calculated from the change in potential.

1. Select the measuring method (see section 7.3 SELECTING THE MEASURING METHOD, page 56).

Calibration

- | | |
|----|---|
| 2. | Prepare two standard calibration solutions. |
| 3. | Perform a two-point calibration according to user guidance. |
| 4. | The calibration record is displayed as soon as a stable value is achieved for the second standard calibration solution. |

CALIBRATION		
ADA 94/IDS BNC		
B092500013		
01.08.2013 08:00		
#1 0.010 mg/l	20.2 mV	25.0 °C
#2 0.020 mg/l	79.2 mV	25.0 °C
Slp.: 54.1 mV		
Sensor +++ (Ion type: Ag)		
01.08.2013 08:00		

Measuring

- Start the measurement with **<F1>** *continue*
An entry window appears.

Blank value addition	
i <i>Immerse sensor in sample</i>	
Sample volume	100.0 ml
ISA/TISAB vol.	1.0 ml
BV volume	100.0 ml
BV conc.	1.000 mg/l
continue	
01.08.2013 08:00	

- Prepare the sample.
- If necessary, add the ISA/TISAB solution to the sample.
- Thoroughly rinse the electrode with deionized water.
- Immerse the electrode in the sample that was supplemented with blank value solution.
- Using **<▲>** **<▼>** and **<ENTER>**, enter the values for the volume of the sample (*Sample volume*), the volume of the ISA/TISAB solution (*ISA/TISAB vol.*), the volume of the blank value solution (*BV volume*) and the concentration of the blank value solution (*BV conc.*).
- Select *continue* with **<▲>** **<▼>** and start the measurement with **<ENTER>**.
When the measurement is finished an entry window appears.

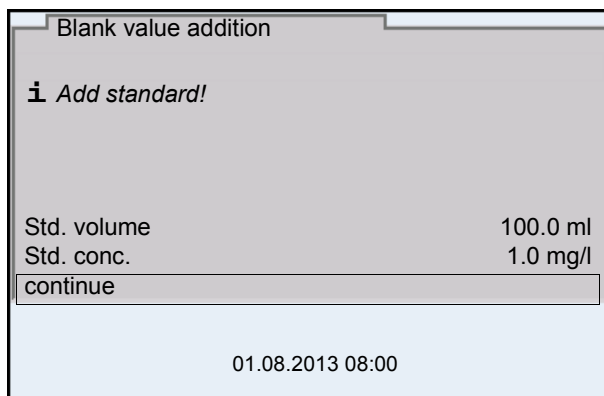

- 12. Add the standard solution to the sample.
- 13. Using <▲> <▼> and <ENTER>, enter the values for the volume of the standard solution (*Std. volume*) and concentration of the standard solution (*Std. conc.*).
- 14. Select *continue* with <▲> <▼> and start the measurement with <ENTER>. The measurement result is displayed when the measurement is completed.

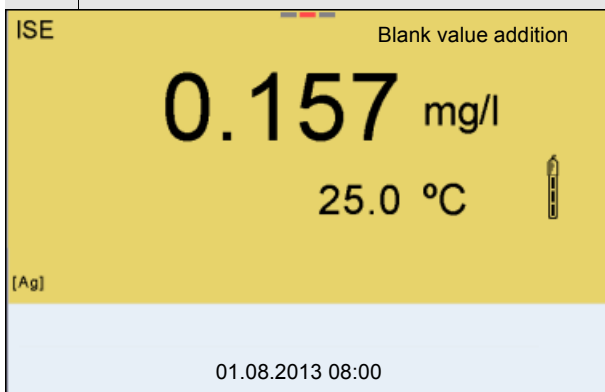

- 15. If necessary, start measuring further samples with <ENTER>. Repeat steps 6 - 14 for all samples.
- 16. Terminate the measuring method with <M>. A safety query appears.
- 17. Select yes with <▲> <▼>.
- 18. Confirm yes with <ENTER>. Measurement with the selected method is completed.

8 Dissolved oxygen (D.O.)

8.1 Measuring

8.1.1 Measuring D.O.

1. Connect the IDS D.O. sensor to the meter.
The D.O. measuring screen is displayed.
2. If necessary, select the measured parameter with **<M>**.
3. Check or calibrate the meter with the sensor.
4. Immerse the D.O. sensor in the test sample.

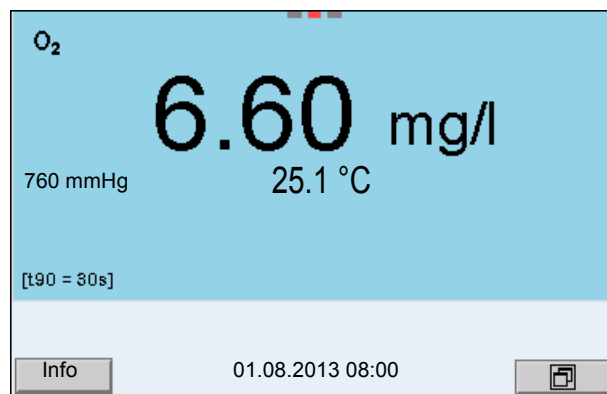

Selecting the displayed measured parameter

You can switch between the following displays with **<M>**:

- D.O. concentration [mg/l]
- D.O. saturation [%]

Salinity correction

When measuring the D.O. concentration of solutions with a salt content of more than 1 psu, a salinity correction is required. For this, you have to measure and input the salinity of the measured medium first.

When the salinity correction is switched on, the [Sal] indicator is displayed in the measuring screen.



You can switch the salinity correction on or off and enter the salinity in the menu for calibration and measurement settings (see section 10.4.1 SETTINGS FOR D.O. MEASUREMENT, page 92).

Air pressure correction (Saturation local function)

The integrated air pressure sensor of the MultiLab 4010-3 measures the current air pressure. During calibration, the air pressure correction function is automatically activated. For measurement, the air pressure correction is applied if the parameter oxygen saturation [%] is displayed and the *Saturation local* function is enabled.

The current air pressure is displayed, when an IDS D.O. sensor is connected.



The *Saturation local* function for the parameter oxygen saturation [%] is switched on or off in the menu for calibration and measurement settings (see section 10.4.3 SATURATION LOCAL, page 92).

Stability control (AutoRead) & HOLD function

The stability control function (*AutoRead*) continually checks the stability of the measurement signal. The stability has a considerable impact on the reproducibility of measured values.

The measured parameter flashes on the display

- as soon as the measured value is outside the stability range
- when the automatic *Stability control* is switched off.

Irrespective of the setting for automatic *Stability control* (see section 10.6.3 AUTOMATIC STABILITY CONTROL, page 97) in the *System* menu, you can start a measurement with *Stability control* manually at any time.

1. Freeze the measured value with **<AR>**.
The [HOLD] status indicator is displayed.
The HOLD function is active.



You can terminate the *Stability control* function and the HOLD function with **<AR>** or **<M>** at any time.

2. Using **<ENTER>**, activate the *Stability control* function manually. The [AR] status indicator appears while the measured value is assessed as not stable. A progress bar is displayed and the display of the measured parameter flashes. As soon as a measured value meets the stability criteria, it is frozen. The [HOLD][AR] status indicator is displayed, the progress bar disappears and the display of the measured parameter stops flashing. The current measurement data is output to the interface. Measurement data meeting the stability control criterion is marked by AR.



You can prematurely terminate the *Stability control* function manually with **<ENTER>** at any time. When the *Stability control* function is prematurely terminated, the current measurement data are output to the interface (PC, USB memory device or USB printer) without AutoRead info.

3. Using **<ENTER>**, start a further measurement with stability control.
or
Release the frozen measured value again with **<AR>** or **<M>**.
The [AR] status display disappears. The display switches back to the previous indication.

Criteria for a stable measured value

The *Stability control* function checks whether the measured values are stable

within the monitored time interval.

Measured parameter	Time interval	Stability in the time interval
D.O. concentration	20 seconds	Δ : better than 0.03 mg/l
D.O. saturation	20 seconds	Δ : better than 0.4 %
Temperature	15 seconds	Δ : Better than 0.5 °C

The minimum duration until a measured value is assessed as stable is the monitored time interval. The actual duration is mostly longer.

8.1.2 Measuring the temperature

For reproducible D.O. measurements, it is essential to measure the temperature of the test sample.

IDS D.O. sensors measure the temperature with a temperature sensor integrated in the IDS sensor.

8.2 Calibration

8.2.1 Why calibrate?

D.O. sensors age. This changes the zero point (asymmetry) and slope of the D.O. sensor. As a result, an inexact measured value is displayed. Calibration determines and stores the current values of the zero point and slope.

8.2.2 When to calibrate?

- When the calibration interval has expired
- When your accuracy requirements are especially high
- Routinely within the framework of the company quality assurance

8.2.3 Calibration procedures

The MultiLab 4010-3 provides 2 calibration procedures:

- Calibration in water vapor-saturated air.
- Calibration via a comparison measurement (e.g. Winkler titration according to DIN EN 25813 or ISO 5813). At the same time, the relative slope is adapted to the comparison measurement by a correction factor. When the correction factor is active, the *[Factor]* indicator appears in the measuring window.

Calibration can be carried out either as a 1-point calibration or 2-point calibration procedure.

8.2.4 1-point calibration

Calibration in water vapor-saturated air (*Cal*) and calibration via *Comparison meas.* according to the Winkler method (*Comp*) are described jointly here.

1. Connect the D.O. sensor to the meter.
2. Check the selected calibration type and selected number of calibration points in the sensor setting menu and, if necessary, change them.
3. Put the IDS D.O. sensor into the calibration medium.
 - When calibrating via comparison measurement (*Comp*):
Put the IDS D.O. sensor into the reference solution.
 - When calibrating in water vapor-saturated air (*Cal*):
Put the IDS D.O. sensor into the calibration vessel with water vapor-saturated air.



As the calibration vessel use a BOD bottle that contains a small amount of clean water (approx. 40 ml).

The sensor must not be immersed in the water. Leave the sensor in the calibration bottle long enough (5 to 10 minutes) so that the air is water vapor-saturated and the sensor can adapt to the ambient temperature.

4. Start the calibration with **<CAL>**.
Cal (calibration in water vapor-saturated air) or *Comp* (calibration via *Comparison meas.* according to the Winkler method) is displayed.
The calibration point (DO Sat) is displayed.

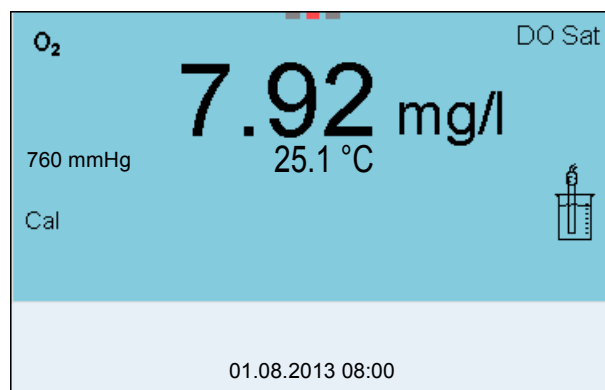

5. Start the measurement with **<ENTER>**.
The measured value is checked for stability (stability control).
The [AR] status indicator is displayed. The measured parameter flashes.

6. Wait for the AutoRead measurement to be completed (audio signal).
 - When calibrating in water vapor-saturated air (Cal):
The calibration record is displayed and output to the interface.
 - When calibrating via comparison measurement (Comp):
Set the concentration value with <▲> <▼> and accept it with <ENTER>.
The calibration record is displayed and output to the interface.

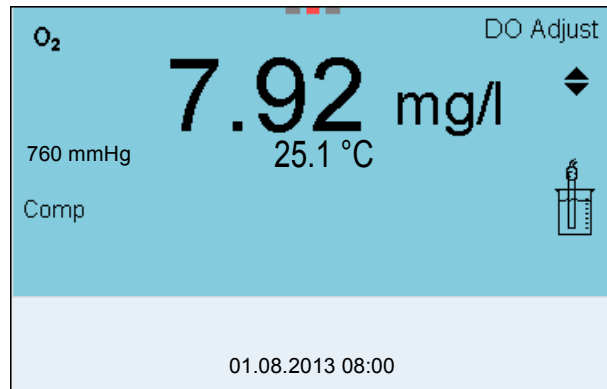

7. Switch to the measured value display with <ENTER>.

8.2.5 2-point calibration

Calibration in water vapor-saturated air (*Cal*) and calibration via *Comparison meas.* according to the Winkler method (*Comp*) are described jointly here.

1. Connect the D.O. sensor to the meter.
2. Check the selected calibration type and selected number of calibration points in the sensor setting menu and, if necessary, change them.
3. Place the D.O. sensor in a solution that does not contain any dissolved oxygen.



A solution not containing any dissolved oxygen can be prepared by dissolving approx. 8 to 10 g sodium sulfite (Na₂SO₃) in 500 ml tap-water. Carefully mix the solution. It may take up to 60 minutes until the solution is free of oxygen.

4. Start the calibration with <CAL>.
Cal (calibration in water vapor-saturated air) or *Comp* (calibration via *Comparison meas.* according to the Winkler method) is displayed.
The calibration point 1 (0%) is displayed.

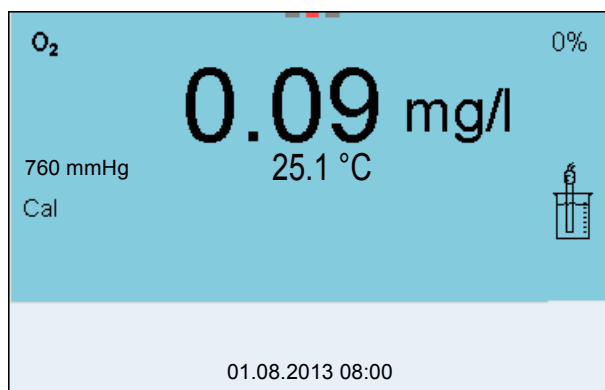

5. Start the measurement with **<ENTER>**.
The measured value is checked for stability (stability control).
The [AR] status indicator is displayed. The measured parameter flashes.
6. Wait for the AutoRead measurement to be completed (audio signal).
The display for the second calibration point is displayed.

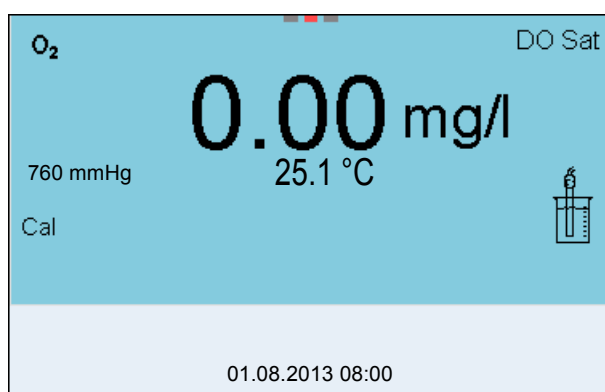

7. Put the IDS D.O. sensor into the calibration medium.
 - When calibrating via comparison measurement (Comp):
Put the IDS D.O. sensor into the reference solution..
 - When calibrating in water vapor-saturated air (Cal):
Put the IDS D.O. sensor into the calibration vessel with water vapor-saturated air.



As the calibration vessel use a BOD bottle that contains a small amount of clean water (approx. 40 ml).

The sensor must not be immersed in the water.
Leave the sensor in the calibration bottle long enough (5 to 10 minutes) so that the air is water vapor-saturated and the sensor can adapt to the ambient temperature.

8. Start the measurement with **<ENTER>**.
The measured value is checked for stability (stability control).
The [AR] status indicator is displayed. The measured parameter flashes.
9. Wait for the AutoRead measurement to be completed (audio signal).
 - When calibrating in water vapor-saturated air (Cal):
The calibration record is displayed and output to the interface.
 - When calibrating via comparison measurement (Comp):
Set the concentration value with **<▲>** **<▼>** and accept it with **<ENTER>**.
The calibration record is displayed and output to the interface.

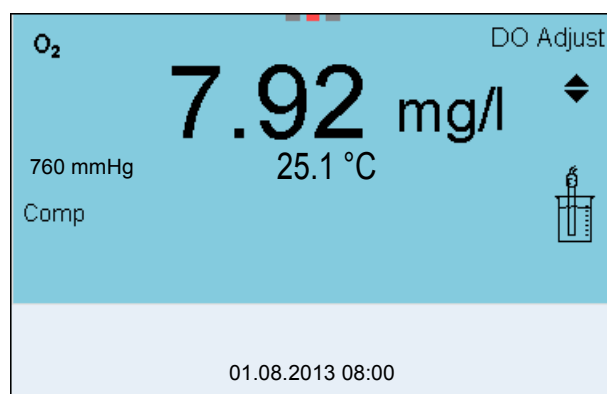

10. Switch to the measured value display with **<ENTER>**.

8.2.6 Calibration data



The calibration record is automatically transmitted to the interface after calibrating.

Displaying the calibration record

The calibration record of the last calibration is to be found under the menu item, *Calibration / Calibration record*. To open it in the measured value display, press the **<CAL_>** key.



The calibration records of the last 10 calibrations are to be found in the menu, *Calibration / Calibration data storage / Display*. To open the *Calibration* menu, press the **<ENTER>** key in the measured value display.

Menu item	Setting/function	Explanation
<i>Calibration / Calibration data storage / Display</i>	-	Displays the calibration records. Further options: <ul style="list-style-type: none"> ● Scroll through the calibration records with << >>. ● Using <PRT>, output the displayed calibration record to the USB-B (PC) interface or the USB-A (USB printer) interface . ● Using <PRT_>, output all calibration records to the USB-B (PC) interface or the USB-A (USB printer) interface . ● Quit the display with <ESC>. ● Switch directly to the measured value display with <M>.
<i>Calibration / Calibration data storage / Output to USB flash drive or printer</i>	-	Outputs the stored calibration data to the USB-A interface (USB memory device/USB printer)
<i>Calibration / Calibration data storage / Output to RS232/USB</i>	-	Outputs the stored calibration data to the USB-B interface (PC)

Calibration evaluation

After calibration, the meter automatically evaluates the current status of the calibration. The evaluation appears on the display and in the calibration record.

ProOBOD calibration evaluation

Display	Calibration record	Relative slope
	+++	S = 0.94 ... 1.06
	++	S = 0.92 ... 0.94 or S = 1.06 ... 1.08
	+	S = 0.90 ... 0.92 or S = 1.08 ... 1.10
<i>Error</i> Error elimination (see section 14 WHAT TO DO IF..., page 115)	<i>Error</i>	S < 0.90 or S > 1.10

Calibration record

CALIBRATION Ox
03.04.2013 07:43:33

ProOBOD
Ser. no. 12B100016

ProOBOD Cap	12B100015
Anzahl der Kalibrierpunkte	1
Sensor	+++

9 Conductivity

9.1 Measuring

9.1.1 Measuring the conductivity



The sensor connection and the USB-B (device) interface are galvanically isolated. This facilitates interference-free measurements also in the following cases:

- Measurement in grounded test samples
- Measurement with several sensors connected to one MultiLab 4010-3 in one test sample

1. Connect the conductivity sensor to the meter. The conductivity measuring window is displayed. The measuring cell and cell constant for the connected IDS conductivity sensor are automatically taken over.
2. If necessary, press **<M>** to select the measured parameter χ .
3. Immerse the conductivity sensor in the test sample.

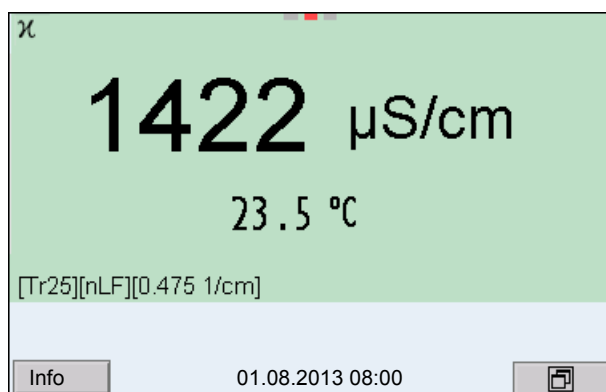

Selecting the displayed measured parameter

You can switch between the following displays with **<M>**:

- Conductivity [$\mu\text{S}/\text{cm}$] / [mS/cm]
- Resistivity [$\Omega\cdot\text{cm}$] / [$\text{k}\Omega\cdot\text{cm}$] / [$\text{M}\Omega\cdot\text{cm}$]
- Salinity SaL [] (Δ psu)
- Total dissolved solids TDS [mg/l] / [g/l]

The factor to calculate the total dissolved solids is set to 1.00 in the factory. You can adjust this factor to meet your requirements in the range 0.40 ... 1.00. The factor is set in the menu for the parameter TDS.

Stability control (AutoRead) & HOLD function

The stability control function (*AutoRead*) continually checks the stability of the measurement signal. The stability has a considerable impact on the reproducibility of measured values.

The measured parameter flashes on the display

- as soon as the measured value is outside the stability range
- when the automatic *Stability control* is switched off.

You can start the *Stability control* manually at any time, irrespective of the setting for automatic *Stability control* (see section 10.6.3 AUTOMATIC STABILITY CONTROL, page 97) in the *System* menu.

1. Freeze the measured value with **<AR>**.
The [HOLD] status indicator is displayed.
The HOLD function is active.



You can terminate the *Stability control* function and the HOLD function with **<AR>** or **<M>** at any time.

2. Using **<ENTER>**, activate the *Stability control* function manually.
The [AR] status indicator appears while the measured value is assessed as not stable. A progress bar is displayed and the display of the measured parameter flashes.
As soon as a measured value meets the stability criteria, it is frozen. The [HOLD][AR] status indicator is displayed, the progress bar disappears and the display of the measured parameter stops flashing.
The current measurement data is output to the interface. Measurement data meeting the stability control criterion is marked by AR.



You can prematurely terminate the *Stability control* function manually with **<ENTER>** at any time. When the *Stability control* function is prematurely terminated, the current measurement data are output to the interface (PC, USB memory device or USB printer) without AutoRead info.

3. Using **<ENTER>**, start a further measurement with stability control.
or
Release the frozen measured value again with **<AR>** or **<M>**.
The [AR] status display disappears. The display switches back to the previous indication.

Criteria for a stable measured value

The *Stability control* function checks whether the measured values are stable within the monitored time interval.

Measured parameter	Time interval	Stability in the time interval
Conductivity χ	10 seconds	$\Delta \chi$: better than 1.0% of measured value
Temperature	15 seconds	Δ : Better than 0.5 °C

The minimum duration until a measured value is assessed as stable is the monitored time interval. The actual duration is mostly longer.

9.1.2 Measuring the temperature

For reproducible conductivity measurements, it is essential to measure the temperature of the test sample.

IDS sensors measure the temperature with a temperature sensor integrated in the IDS sensor.

9.2 Temperature compensation

The calculation of the temperature compensation is based on the preset reference temperature, 20 °C or 25 °C. It appears on the display as *Tr20* or *Tr25*.

You can select one of the following temperature compensation methods:

- **Nonlinear temperature compensation (*nLF*)** according to ISO 7888
- **Linear temperature compensation (*lin*)** with adjustable coefficients of 0.000 ... 3.000 %/K
- **No temperature compensation (*off*)**



The reference temperature and temperature compensation are set in the menu for the parameter, conductivity (see section 10.5.1 SETTINGS FOR IDS CONDUCTIVITY SENSORS, page 92).

Application tips

Select the following temperature compensations given in the table according to the respective test sample:

Test sample	Temperature compensation	Display
Natural water (ground water, surface water, drinking water)	<i>nLF</i> according to ISO 7888	<i>nLF</i>
Ultrapure water	<i>nLF</i> according to ISO 7888	<i>nLF</i>
Other aqueous solutions	<i>lin</i> Set linear temperature coefficient 0.000 ... 10.000 %/K	<i>lin</i>
Salinity (seawater)	Automatic <i>nLF</i> according to IOT (International Oceanographic Tables)	<i>Sal, nLF</i>

9.3 Calibration

9.3.1 Why calibrate?

Aging slightly changes the cell constant, e. g. due to coatings. As a result, an inexact measured value is displayed. The original characteristics of the cell can often be restored by cleaning the cell. Calibration determines the current value of the cell constant and stores this value in the meter.

Thus, you should calibrate at regular intervals.

9.3.2 When to calibrate?

- After connecting a sensor
- Routinely within the framework of the company quality assurance
- When the cleaning interval has expired

9.3.3 Determining the cell constant (calibration in control standard)

You can determine the actual cell constant of the IDS conductivity sensor by calibrating with the control standard in the following range:

- $0.450 \dots 0.500 \text{ cm}^{-1}$
(e.g. 4310, nominal cell constant 0.475 cm^{-1})

The cell constant is determined in the control standard, 0.01 mol/l KCl.

In the delivery condition, the calibrated cell constant of the IDS sensor is set to 0.475 cm^{-1} (4310 IDS conductivity sensor).

For this calibration procedure, the *Type* setting must be set to *cal*. Proceed as follows to determine the cell constant:

1. Connect the conductivity sensor to the meter.
2. In the measured value display, select the conductivity parameter with **<M>**.
3. Start the calibration with **<CAL>**.
The cell constant that was calibrated last is displayed.



4. Immerse the conductivity sensor in the control standard solution, 0.01 mol/l KCl.
5. Start the measurement with **<ENTER>**.
The measured value is checked for stability (stability control).
The [AR] status indicator is displayed. The measured parameter flashes.
6. Wait for the end of the measurement with stability control
or
take over the calibrated value with **<ENTER>**.
The calibration record is displayed and output to the interface.
7. Switch to the measured value display with **<ENTER>**.

9.3.4 Calibration data



The calibration record is automatically transmitted to the interface after calibrating.

Displaying the calibration record

The calibration data can be displayed and then output to the interface.

The calibration record of the last calibration is to be found under the menu item, *Calibration / Calibration record*. To open it in the measured value display, press the **<CAL_>** key.

The calibration records of the last 10 calibrations are to be found in the menu, *Calibration / Calibration data storage / Display*. To open the *Calibration* menu, press the **<ENTER>** key in the measured value display.

Menu item	Setting/function	Explanation
<i>Calibration / Calibration data storage / Display</i>	-	<p>Displays the calibration records.</p> <p>Further options:</p> <ul style="list-style-type: none"> ● Scroll through the calibration records with <<>>. ● Using <PRT>, output the displayed calibration record to the USB-B (PC) interface or the USB-A (USB printer) interface . ● Using <PRT_>, output all calibration records to the USB-B (PC) interface or the USB-A (USB printer) interface . ● Quit the display with <ESC>. ● Switch directly to the measured value display with <M>.

Menu item	Setting/ function	Explanation
<i>Calibration / Calibration data storage / Output to USB flash drive or printer</i>	-	Outputs the stored calibration data to the USB-A interface (USB memory device/USB printer)
<i>Calibration / Calibration data storage / Output to RS232/USB</i>	-	Outputs the stored calibration data to the USB-B interface (PC)

Calibration evaluation

After calibration, the meter automatically evaluates the current status of the calibration. The evaluation appears on the display and in the calibration record.

Display	Calibration record	Cell constant [cm^{-1}]
	+++	Within the range $0.450 \dots 0.500 \text{ cm}^{-1}$
<i>Error</i> Error elimination (see section 14 WHAT TO DO IF..., page 115)	<i>Error</i>	Outside the range $0.450 \dots 0.500 \text{ cm}^{-1}$

Calibration record

```

CALIBRATION Cond
03.04.2013 07:43:33

4310
Ser. no. 09250033

Cell constant 0.476 1/cm
25.0 °C
Sensor                +++

```

10 Settings

10.1 pH measurement settings

10.1.1 Settings for pH measurements

The settings are made in the menu for calibration and measurement settings of the pH/ORP measurement. To open the settings, display the required measured parameter in the measured value display and press the **<ENTER>** key. After completing the settings, switch to the measured value display with **<M>**. Default settings are printed in **bold**.

Menu item	Possible setting	Explanation
<i>Calibration / Calibration record</i>	-	Displays the calibration record of the last calibration.
<i>Calibration / Calibration data storage / Display</i>	-	Displays the last calibration records (max. 10)
<i>Calibration / Calibration data storage / Output to RS232/USB</i>	-	Outputs the stored calibration data to the USB-B interface (PC)
<i>Calibration / Calibration data storage / Output to USB flash drive or printer</i>	-	Outputs the stored calibration data to the USB-A interface (USB memory device/USB printer)
<i>Calibration / Buffer</i>	YSI ConCal NIST/DIN ...	Buffer sets to be used for pH calibration. More buffers and details: see section 10.1.2 BUFFER SETS FOR CALIBRATION, page 86 and section 5.2 PH CALIBRATION, page 29.
<i>Calibration / Single-point calibration</i>	yes no	Quick calibration with 1 buffer
<i>Calibration / Calibration interval</i>	1 ... 7 ... 999 d	<i>Calibration interval</i> for the IDS pH sensor (in days). The meter reminds you to calibrate regularly by the flashing sensor symbol in the measuring screen.
<i>Calibration / Unit for slope</i>	mV/pH %	Unit of the slope. The % display refers to the Nernst slope of -59.2 mV/pH (100 x determined slope/Nernst slope).
<i>QSC / First calibration</i>	-	Starts the initial calibration with QSC buffers. This menu item is only available as long as no initial calibration was carried out with the connected IDS sensor.
<i>QSC / Record of first calibration</i>	-	Displays the calibration record of the QSC initial calibration.
<i>QSC / Control calibration</i>	-	Starts the control calibration with QSC buffers. This menu item is only available if an initial calibration was carried out with the connected IDS sensor.

Menu item	Possible setting	Explanation
<i>Alternative temperature</i>	<i>on</i> <i>off</i>	Takes the measured temperature value from an IDS sensor. This menu item is only available if an IDS adapter and an IDS sensor with temperature sensor are connected.
<i>Temperature from channel</i>	<input type="checkbox"/> <input type="checkbox"/> <input checked="" type="checkbox"/> <input type="checkbox"/> <input checked="" type="checkbox"/> <input type="checkbox"/> <input checked="" type="checkbox"/> <input type="checkbox"/> <input type="checkbox"/>	Selection of the channel from which the temperature value should be taken over. This menu item is only available if two IDS sensors are additionally connected.
<i>Man. temperature</i>	-25 ... +25 ... +130 °C	Entry of the manually determined temperature. This menu item is only available if an IDS adapter is connected.
<i>pH resolution</i>	0.001 0.01 0.1	Resolution of the pH display
<i>mV resolution</i>	0.1 1	Resolution of the mV display
<i>Limit monitoring</i>		With the <i>Limit monitoring</i> function you define the measured values whose exceeding is signaled. An acoustic signal sounds, and at the same time a message is output to the USB interface. You can switch on or off the acoustic signal in the <i>System</i> menu (see section 10.6.1 SYSTEM, page 96).
<i>Limit monitoring/ pH monitoring</i>	<i>on</i> <i>off</i>	Switch on or off the limit signaling device for the pH value.
<i>Limit monitoring/ TP monitoring</i>	<i>on</i> <i>off</i>	Switch on or off the limit signaling device for the temperature value.
<i>Limit monitoring/ pH monitoring/ on/ pH upper limit</i>	-2 ... 20	Upper limit. A message is output to the USB interface if it is exceeded. This menu item is only visible when the <i>pH monitoring</i> setting is active.
<i>Limit monitoring/ pH monitoring/ on/ pH lower limit</i>	-2 ... 20	Lower limit. A message is output to the USB interface if it is exceeded. This menu item is only visible when the <i>pH monitoring</i> setting is active.
<i>Limit monitoring/ TP monitoring/ on/ TP upper limit</i>	-5 ... +105 °C	Upper limit. A message is output to the USB interface if it is exceeded. This menu item is only visible when the <i>TP monitoring</i> setting is active.
<i>Limit monitoring/ TP monitoring/ on/ TP lower limit</i>	-5 ... 105 °C	Lower limit. A message is output to the USB interface if it is exceeded. This menu item is only visible when the <i>TP monitoring</i> setting is active.

Menu item	Possible setting	Explanation
<i>Reset</i>	-	Resets all sensor settings to the delivery condition (see section 10.7.1 RESETTING THE MEASUREMENT SETTINGS, page 98).

10.1.2 Buffer sets for calibration

You can use the buffer sets quoted in the table for an automatic calibration. The pH values are valid for the specified temperature values. The temperature dependence of the pH values is taken into consideration during the calibration.

No.	Buffer set *	pH values	at
1	<i>YSI</i> *	4.000 7.000 10.000	25 °C
2	<i>ConCal</i>	Any	Any
3	<i>NIST/DIN</i> DIN buffers according to DIN 19266 and NIST Traceable Buffers	1.679 4.006 6.865 9.180 12.454	25 °C
4	<i>TEC</i> Technical buffers	2.000 4.010 7.000 10.011	25 °C
5	<i>Merck 1</i> *	4.000 7.000 9.000	20 °C
6	<i>Merck 2</i> *	1.000 6.000 8.000 13.000	20 °C
7	<i>Merck 3</i> *	4.660 6.880 9.220	20 °C
8	<i>Merck 4</i> *	2.000 4.000 7.000 10.000	20 °C
9	<i>Merck 5</i> *	4.010 7.000 10.000	25 °C

No.	Buffer set *	pH values	at
10	<i>DIN 19267</i>	1.090 4.650 6.790 9.230	25 °C
11	<i>Mettler Toledo USA *</i>	1.679 4.003 7.002 10.013	25 °C
12	<i>Mettler Toledo EU *</i>	1.995 4.005 7.002 9.208	25 °C
13	<i>Fisher *</i>	2.007 4.002 7.004 10.002	25 °C
14	<i>Fluka BS *</i>	4.006 6.984 8.957	25 °C
15	<i>Radiometer *</i>	1.678 4.005 7.000 9.180	25 °C
16	<i>Baker *</i>	4.006 6.991 10.008	25 °C
17	<i>Metrohm *</i>	3.996 7.003 8.999	25 °C
18	<i>Beckman *</i>	4.005 7.005 10.013	25 °C
19	<i>Hamilton Duracal *</i>	4.005 7.002 10.013	25 °C
20	<i>Precisa *</i>	3.996 7.003 8.999	25 °C
21	<i>Reagecon TEC *</i>	2.000 4.010 7.000 10.000	25 °C

No.	Buffer set *	pH values	at
22	<i>Reagecon 20</i> *	2.000 4.000 7.000 10.000 13.000	20 °C
23	<i>Reagecon 25</i> *	2.000 4.000 7.000 10.000 13.000	25 °C
24	<i>Chemsolute</i> *	2.000 4.000 7.000 10.000	20 °C
25	<i>USABlueBook</i> *	4.000 7.000 10.000	25 °C

* Brand names or trade names are trademarks of their respective owners protected by law.



The buffers are selected in the menu, pH / **<ENTER>** / *Calibration / Buffer* (see section 10.1.1 SETTINGS FOR PH MEASUREMENTS, page 84).

10.1.3 Calibration interval

The calibration evaluation is displayed as a sensor symbol.

After the QSC function has been enabled the sensor symbol is replaced by the QSC scale (see section 5.2.8 QSC FUNCTION (SENSOR QUALITY CONTROL), page 40).

After the specified calibration interval has expired the sensor symbol or the QSC scale flashes. It is still possible to measure.



To ensure the high measuring accuracy of the measuring system, calibrate after the calibration interval has expired.

Setting the calibration interval

The calibration interval is set to 7 days in the factory. You can change the interval (1 ... 999 days):

1. Open the menu for measurement settings with **<ENTER>**.
2. In the *Calibration / Calibration interval* menu, set the calibration interval with **<▲><▼>**.

3. Confirm the setting with **<ENTER>**.
4. Quit the menu with **<M>**.

10.2 ORP measurement settings

Settings

The settings are made in the menu for measuring settings of the ORP measurement. To open the settings, display the required measured parameter in the measured value display and press the **<ENTER>** key. After completing the settings, switch to the measured value display with **<M>**.

Default settings are printed in **bold**.

Menu item	Possible setting	Explanation
<i>mV resolution</i>	0.1 1	Resolution of the mV display
<i>Reset</i>	-	Resets all sensor settings to the delivery condition (see section 10.7.1 RESETTING THE MEASUREMENT SETTINGS, page 98).

10.3 ISE measurement settings

The settings are made in the measuring menu of the ISE measurement. To open the settings, activate the relevant measuring window in the measured value display and press the **<ENTER>** key shortly. After completing the settings, switch to the measured value display with **<M>**.

The following settings are possible for ISE measurements:

Menu item	Possible setting	Description
<i>Calibration / Calibration record</i>	-	Displays the calibration record of the last calibration.

Menu item	Possible setting	Description
<i>Calibration / Calibration data stor- age / Display</i>	-	Displays the calibration record. Further options: <ul style="list-style-type: none"> ● Scroll through the calibration records with <▲><▼>. ● Output the displayed calibration record to the interface with <F2>/[USB-Ausgabe]. ● Output all calibration records to the interface with <F2_>[USB-Ausgabe]. ● Quit the display with <F1>/[Back] or <ENTER>. ● Switch directly to the measured value display with <M>.
<i>Calibration / Calibration data stor- age / Output to RS232/ USB</i>	-	Outputs the calibration records to the interface.
<i>Man. temperature</i>	-25 ... +25 ... +130 °C	Entry of the manually determined temperature. For measurements without temperature sensor only.
<i>Alternative tempera- ture</i>	<i>on</i> off	Takes the measured temperature value from an IDS sensor. This menu item is only available if an IDS adapter and an IDS sensor with temperature sensor are connected.
<i>Temperature from channel</i>	<input type="checkbox"/> <input type="checkbox"/> <input checked="" type="checkbox"/> <input type="checkbox"/> <input checked="" type="checkbox"/> <input type="checkbox"/> <input checked="" type="checkbox"/> <input type="checkbox"/> <input type="checkbox"/>	Selection of the channel from which the temperature value should be taken over. This menu item is only available if two IDS sensors are additionally connected.
<i>ISE setup / AutoRead criterion</i>	<i>low</i> <i>medium</i> high	Selection of the AutoRead criteria (see section 7.1.1 MEASURING THE ION CONCENTRATION, page 47).

Menu item	Possible setting	Description
<i>ISE setup / Ion type</i>	Ag , Br, Ca, Cd, Cl, CN, Cu, F, I, K, Na, NO ₃ , Pb, S, NH ₃ , NH ₄ [*] , CO ₂ , ION	Selection of the ion type to be measured. An ion that is not included in the list can be measured with the setting, ION.
	* Measuring with the NH 500 electrode: The NH ₄ setting is not suitable for the gas-sensitive electrode NH 500. Select the following settings: <i>Ion type "ION", Valency "-1"</i> .	
<i>ISE setup / Unit</i>	mg/l μmol/l mg/kg ppm %	Selection, with which unit the measurement result and calibration standards should be displayed.
<i>ISE setup / Valency</i>	-8 ... +8	Set the valence (<i>Valency</i>) and molar weight (<i>Molar mass</i>) for the ion (only with <i>Unit</i> : mg/kg, ppm, %)
<i>ISE setup / Molar mass</i>	1 ... 300 g/mol	
<i>ISE setup / Density</i>	0.001 ... 9.999 g/ml or kg/l	Adjustable density of the test sample (only with <i>Unit</i> : mg/kg, ppm, %)
<i>Method</i>	<i>Standard addition</i> <i>Standard subtraction</i> <i>Sample addition</i> <i>Sample subtraction</i> <i>Blank value addition</i>	Selection of the available measuring methods.
<i>Start method</i>		Start measurement with the selected method.

10.4 D.O. measurement settings

10.4.1 Settings for D.O. measurement

The settings are available in the menu for measurement and calibration settings. To open the settings, display the required measured parameter in the measured value display and press the **<ENTER>** key. After completing the settings, switch to the measured value display with **<M>**.

10.4.2 Enter Sensor Cap coefficients



The values of the coefficients are provided with the sensor cap.

1. Change the digit of the highlighted position with **<▲><▼>**.
2. Go to the next position with **<◀><▶>**.
3. Confirm with **<ENTER>** when a coefficient is completely entered.

10.4.3 Saturation local

Irrespective of the height or air pressure, the calibration value is set to 100%. *Saturation local* is ideal for EU compliance.

When *Saturation local* is enabled, an L will appear next to D.O.% on the display.

D.O. mg/L readings are unaffected by the selection of *Saturation local*.

10.5 Cond measurement settings

10.5.1 Settings for IDS conductivity sensors

The settings are made in the menu for the measured parameter, conductivity. To open the settings, display the required measured parameter in the measured value display and press the **<ENTER>** key. After completing the settings, switch to the measured value display with **<M>**.

The possible settings are individually displayed for each sensor. Below the setting menu is displayed for two IDS sensors (4310, 4320).

Default settings are printed in **bold**.

Setting menu of
4310

Menu item	Possible setting	Explanation
<i>Calibration / Calibration record</i>	-	Displays the calibration record of the last calibration.

Menu item	Possible setting	Explanation
<i>Calibration / Calibration data storage / Display</i>	-	Displays the last calibration records (max. 10)
<i>Calibration / Calibration data storage / Output to USB flash drive or printer</i>	-	Outputs the stored calibration data to the USB-A interface (USB memory device/USB printer)
<i>Calibration / Calibration data storage / Output to RS232/USB</i>	-	Outputs the stored calibration data to the USB-B interface (PC)
<i>Calibration / Calibration interval</i>	1 ... 150 ... 999 d	<i>Calibration interval</i> for the IDS conductivity sensor (in days). The meter reminds you to calibrate regularly by the flashing sensor symbol in the measuring screen.
<i>Type</i>	<i>Cal</i> <i>man</i>	Used measuring cell Measuring cells whose cell constant is determined by calibration in the KCl control standard solution. Calibration range: 0.450 to 0.500 cm ⁻¹ The currently valid cell constant is displayed in the status line. Freely adjustable cell constant in the range 0.450 ... 0.500 cm ⁻¹ .
<i>Man. cell const.</i>	0.450 ... 0.475 ... 0.500 cm⁻¹	Display and setting options for the cell constant.
<i>Temp. comp. (TC) / Method</i>	nLF <i>lin</i> <i>off</i>	Procedure for temperature compensation (see section 9.2 TEMPERATURE COMPENSATION, page 80). This setting is only available for the measured parameters, χ and ρ .
<i>Temp. comp. (TC) / Linear coeff.</i>	0.000 ... 2.000 ... 3.000 %/K	Coefficient of the linear temperature compensation. This menu item is only available when the linear temperature compensation is set.
<i>Temp. comp. (TC) / Reference temp.</i>	20 °C 25 °C	Reference temperature This setting is only available for the measured parameters, χ and ρ .
<i>Multiplier for TDS</i>	0.40 ... 1.00	Factor for TDS value

Menu item	Possible setting	Explanation
<i>Reset</i>	-	Resets all sensor settings to the delivery condition (see section 10.7.1 RESETTING THE MEASUREMENT SETTINGS, page 98).

Setting menu of 4320	Menu item	Possible setting	Explanation
	<i>Cell constant</i>	0.090 0.100 ... 0.110 cm ⁻¹	Display and setting options for the cell constant
	<i>Temp. comp. (TC) / Method</i>	nLF <i>lin</i> <i>off</i>	Procedure for temperature compensation (see section 9.2 TEMPERATURE COMPENSATION, page 80). This setting is only available for the measured parameters, χ and ρ .
	<i>Temp. comp. (TC) / Linear coeff.</i>	0.000 ... 2.000 ... 3.000 %/K	Coefficient of the linear temperature compensation. This menu item is only available when the linear temperature compensation is set.
	<i>Temp. comp. (TC) / Reference temp.</i>	20 °C 25 °C	Reference temperature This setting is only available for the measured parameters, χ and ρ .
	<i>Multiplier for TDS</i>	0.40 ... 1.00	Factor for TDS value
	<i>Reset</i>	-	Resets all sensor settings to the delivery condition (see section 10.7.1 RESETTING THE MEASUREMENT SETTINGS, page 98).

10.6 Sensor-independent settings

10.6.1 System

To open the *Storage & config* menu, press the **<ENTER_>** key in the measured value display. After completing the settings, switch to the measured value display with **<M>**.

Default settings are printed in **bold**.

Menu item	Setting	Explanation
<i>System / General / Language</i>	<i>Deutsch</i> English <i>(more)</i>	Selects the menu language
<i>System / General / Audio signal</i>	on <i>off</i>	Switches on/off the beep on key-stroke
<i>System / General / Brightness</i>	<i>0 ...</i> 10 <i>... 22</i>	Changes the display brightness
<i>System / General / Temperature unit</i>	°C <i>°F</i>	Temperature unit, degrees Celsius or degrees Fahrenheit. All temperature values are displayed with the selected unit.
<i>System / General / Stability control</i>	on <i>off</i>	Switches on or off the automatic stability control during measurement (see section 10.6.3 AUTOMATIC STABILITY CONTROL, page 97)
<i>System / Interface / Baud rate</i>	<i>1200, 2400,</i> 4800 , <i>9600, 19200</i>	Baud rate of the USB Device interface
<i>System / Interface / Output format</i>	ASCII <i>CSV</i>	Output format for data transmission For details, see section 12 TRANSMITTING DATA, page 108
<i>System / Interface / Decimal separator</i>	Dot (xx.x) <i>Comma (xx,x)</i>	Decimal separator
<i>System / Interface / Output header</i>		Output of a header for <i>Output format: CSV</i>
<i>System / Clock function</i>	<i>Date format</i> Datum <i>Time</i>	Settings of time and date. For details, see section 4.5.5 EXAMPLE 2 ON NAVIGATION: SETTING THE DATE AND TIME, page 25
<i>System / Service information</i>		Hardware version and software version of the meter are displayed.
<i>System / Reset</i>	-	Resets the system settings to the default values. For details, see section 10.7.2 RESETTING THE SYSTEM SETTINGS, page 101

10.6.2 *Data storage*

This menu contains all functions to display, edit and erase stored measured values.



Detailed information on the memory functions of the MultiLab 4010-3 are given in section 11 DATA STORAGE, page 102.

10.6.3 *Automatic Stability control*

The automatic *Stability control* (AutoRead) function continuously checks the stability of the measurement signal. The stability has a considerable impact on the reproducibility of measured values.

You can activate or switch off the automatic *Stability control* function (see section 10.6 SENSOR-INDEPENDENT SETTINGS, page 96).

The measured parameter flashes on the display

- as soon as the measured value is outside the stability range
- when you switch over between the measured parameters with **<M>**.
- when the automatic *Stability control* is switched off.

10.7 Reset

You can reset (initialize) all sensor settings and sensor-independent settings separately from each other.

10.7.1 Resetting the measurement settings



The calibration data are reset to the default settings together with the measuring parameters. Recalibrate after performing a reset.

pH The following settings for pH measurements are reset to the default settings with the *Reset* function:

Setting	Default settings
<i>Buffer</i>	YSI
<i>Calibration interval</i>	7 d
<i>Unit for slope</i>	mV/pH
<i>Measured parameter</i>	pH
<i>pH resolution</i>	0.001
<i>mV resolution</i>	0.1
<i>Asymmetry</i>	0 mV
<i>Slope</i>	-59.2 mV
<i>Man. temperature</i>	25 °C
<i>Single-point calibration</i>	off

The sensor settings are reset under the *Reset* menu item in the menu for calibration and measurement settings. To open the settings, display the required measured parameter in the measured value display and press the **<ENTER>** key.

ORP The following settings for ORP measurements are reset to the default settings with the *Reset* function:

Setting	Default settings
<i>mV resolution</i>	0.1
<i>Man. temperature</i>	25 °C

The sensor settings are reset under the *Reset* menu item in the menu for calibration and measurement settings. To open the settings, display the required measured parameter in the measured value display and press the **<ENTER>** key.

ISE The following settings for ISE measurements are reset to the default settings with the *Reset* function:

Setting	Default settings
<i>AutoRead criterion</i>	<i>high</i>
<i>Ion type</i>	Ag
<i>Unit</i>	mg/l
<i>Man. temperature</i>	25 °C
<i>Alternative temperature</i>	<i>off</i>
<i>Method</i>	<i>Standard addition</i>

The sensor settings are reset under the *Reset* menu item in the menu for calibration and measurement settings. To open the settings, display the required measured parameter in the measured value display and press the **<ENTER>** key.

Dissolved oxygen The following settings for D.O. measurements are reset to the default settings with the *Reset* function:

Setting	Default settings
<i>Calibration interval</i>	180 d
<i>Check interval</i>	60 d
<i>Measured parameter</i>	D.O. concentration
<i>Relative slope (S_{Rel})</i>	1.00
<i>Salinity (value)</i>	0.0
<i>Salinity (function)</i>	Off

The sensor settings are reset under the *Reset* menu item in the menu for calibration and measurement settings. To open the settings, display the required measured parameter in the measured value display and press the **<ENTER>** key.

Conductivity The following settings for conductivity measurements are reset to the default settings with the *Reset* function:

Setting	Default settings
<i>Calibration interval</i>	150 d
<i>Measured parameter</i>	χ
<i>Cell constant (c)</i>	Depending on the connected measuring cell: 0.475 cm ⁻¹ (calibrated) 0.475 cm ⁻¹ (set) 0.100 cm ⁻¹
<i>Temperature compensation</i>	nLF

Setting	Default settings
<i>Reference temperature</i>	25 °C
<i>Temperature coefficient (TC) of the linear temperature compensation</i>	2.000 %/K
<i>Multiplier for TDS</i>	1.00

The sensor settings are reset under the *Reset* menu item in the menu for calibration and measurement settings. To open the settings, display the required measured parameter in the measured value display and press the **<ENTER>** key.

10.7.2 Resetting the system settings

The following system settings can be reset to the default condition:

Setting	Default settings
<i>Language</i>	English
<i>Audio signal</i>	on
<i>Baud rate</i>	4800 Baud
<i>Output format</i>	ASCII
<i>Decimal separator</i>	Dot (xx.x)
<i>Brightness</i>	10
<i>Temperature unit</i>	°C
<i>Stability control</i>	on

The system settings are reset in the menu, *Storage & config / System / Reset*. To open the *Storage & config* menu, press the **<ENTER_>** key in the measured value display.

11 Data storage

You can transmit measured values (datasets) to the data storage:

- Manual data storage (see section 11.1 MANUAL DATA STORAGE, page 102)
- Automatic data storage at intervals (see section 11.2 AUTOMATIC DATA STORAGE AT INTERVALS, page 102)

11.1 Manual data storage

You can transmit a measurement dataset to the data storage as follows. The dataset is at the same time output to the interface:

1. Press the **<STO>** key shortly.
The menu for manual data storage appears.

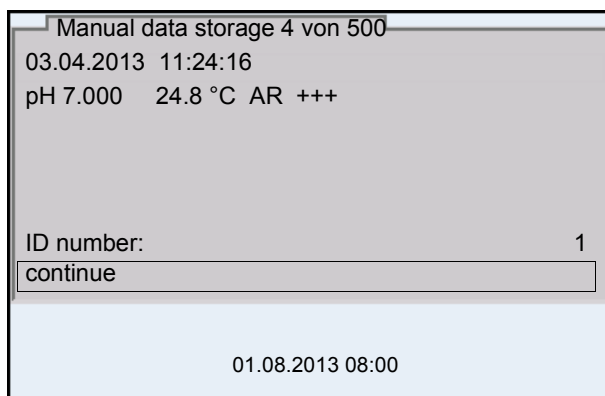

2. If necessary, change and confirm the ID number (1 ... 10000) with **<▲><▼>** and **<ENTER>**.
The dataset is stored. The meter switches to the measured value display.

If the storage is full

When all storage locations are occupied, it is not possible to continue storing. Then you can e.g. transmit the stored data to a PC or a USB flash drive (see section 11.3.1 EDITING THE MEASUREMENT DATA STORAGE, page 105) and subsequently erase the storage (see section 11.3.2 ERASING THE MEASUREMENT DATA STORAGE, page 106).

11.2 Automatic data storage at intervals

The storage interval (*Interval*) determines the time interval between automatic data storage processes. Each data storage process transmits the current dataset to the interface at the same time.

Configuring the automatic storage function

1. Press the **<STO_>** key.
The menu for automatic data storage appears.

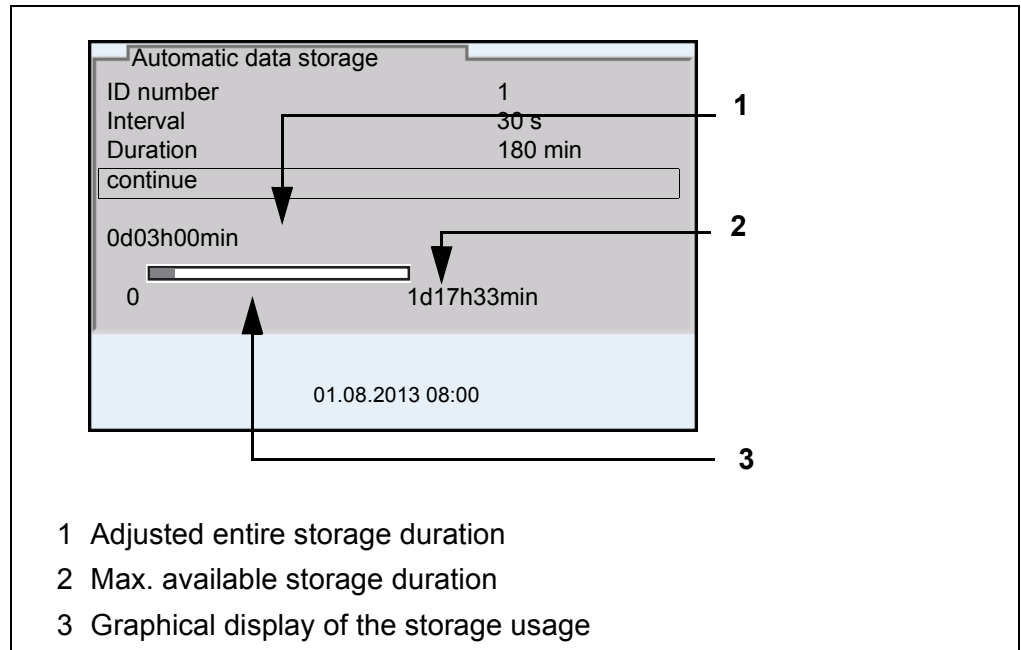

Settings You can configure the automatic data storage function with the following settings:

Menu item	Possible setting	Explanation
<i>ID number</i>	1 ... 10000	ID number for the dataset series.
<i>Interval</i>	1 s, 5 s, 10 s, 30 s, 1 min, 5 min, 10 min, 15 min, 30 min, 60 min	Storage interval. The lower limit of the storage interval can be restricted by the number of free storage locations. The upper limit is restricted by the storage duration.
<i>Duration</i>	1 min ... x min	Storage duration. Specifies after which time the automatic data storage should be terminated. The lower limit of the storage duration is restricted by the storage interval. The upper limit is restricted by the number of free storage locations.

Starting the automatic storage function

To start the automatic storage function, select *continue* with $\langle \blacktriangle \rangle \langle \blacktriangledown \rangle$ and confirm with $\langle \text{ENTER} \rangle$. The meter switches to the measured value display.

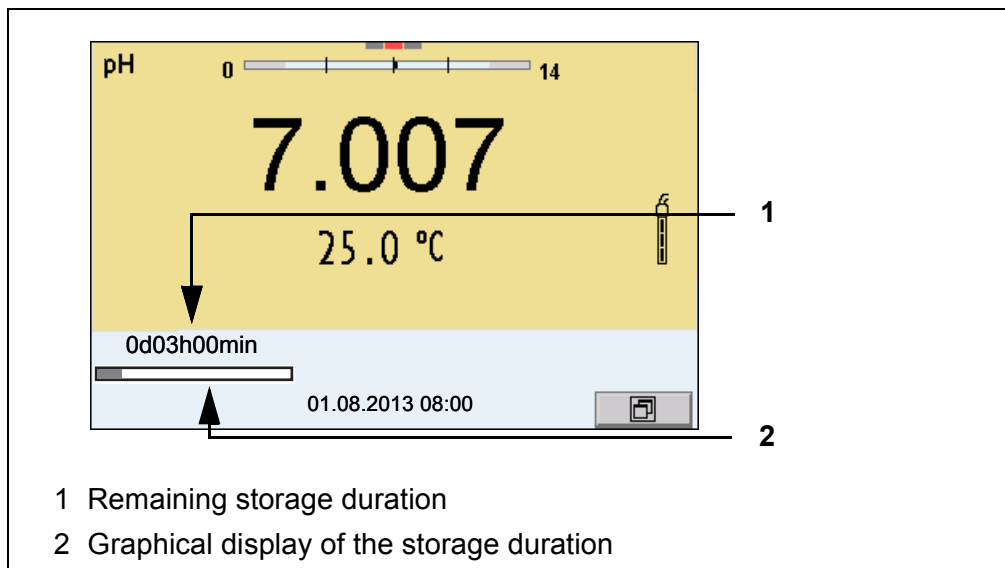

The active automatic data storage function can be recognized by the progress bar in the status line. The progress bar indicates the remaining storage duration.



If the automatic data storage function is activated, only the following keys are active: $\langle \text{M} \rangle$, $\langle \text{STO}_- \rangle$ and $\langle \text{On/Off} \rangle$. The other keys and the automatic switch-off function are deactivated.

Terminating the automatic storage function prematurely

Proceed as follows to switch off the automatic data storage function before the adjusted storage duration has expired:

1. Press the $\langle \text{STO}_- \rangle$ key.
The following window appears.

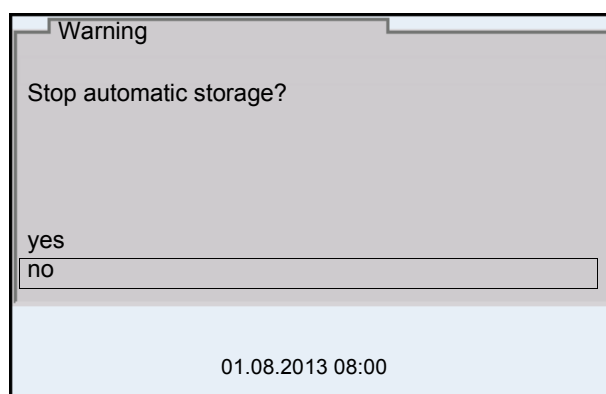

2. Using $\langle \blacktriangle \rangle \langle \blacktriangledown \rangle$, select *yes* and confirm with $\langle \text{ENTER} \rangle$.
The meter switches to the measured value display.
The automatic data storage function is terminated.

11.3 Measurement data storage

11.3.1 Editing the measurement data storage

The contents of the manual or automatic measurement data storage can be shown on the display.

Each of the measurement data storages has a function to erase the entire contents.

Editing the data storage

The storage is edited in the menu, *Storage & config / Data storage*. To open the *Storage & config* menu, press the **<ENTER_>** key in the measured value display.

Open the manual or automatic storage directly with the **<RCL>** or **<RCL_>** key.



The settings are explained here using the manual data storage as an example. The same settings and functions are available for the automatic data storage.

Settings

Menu item	Setting/function	Explanation
<i>Data storage / Manual data storage / Display</i>	-	Displays all measurement datasets page by page. Further options: <ul style="list-style-type: none"> ● Scroll through the datasets with <<>>. ● Output the displayed dataset to the interface with <PRT>. ● Quit the display with <ESC>.
<i>Data storage / Manual data storage / Output to USB flash drive or printer</i>	-	Outputs all stored measured values to the USB-A interface (USB memory device/USB printer)
<i>Data storage / Manual data storage / Output to RS232/USB</i>	-	Outputs all stored measurement data to the USB-B interface (PC)
<i>Data storage / Manual data storage / Erase</i>	-	Erases the entire manual measurement data storage. Note: All calibration data remain stored when this action is performed.

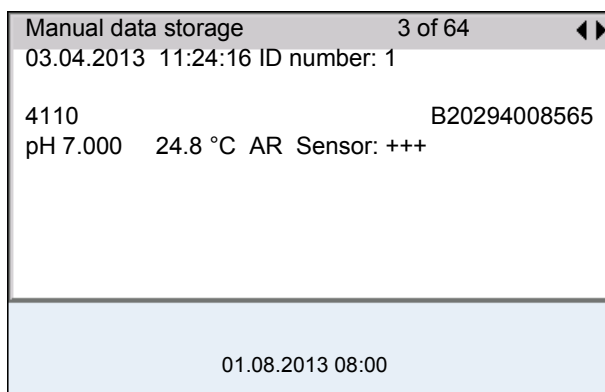
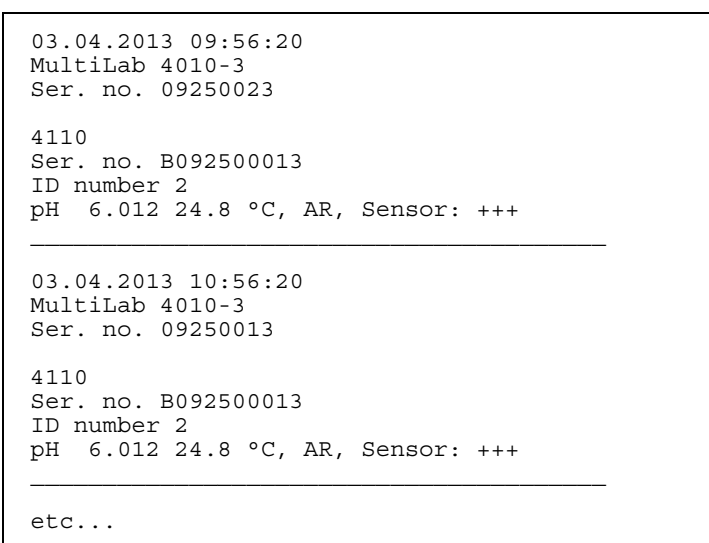
**Display presentation
of a dataset****Sample printout****Quitting the display**

To quit the display of stored measurement datasets, you have the following options:

- Switch directly to the measured value display with **<M>**.
- Quit the display and move to the next higher menu level with **<ESC>**.

11.3.2 Erasing the measurement data storage

How to erase the measured value storage is described in section 11.3.1 EDITING THE MEASUREMENT DATA STORAGE, page 105.

11.3.3 Measurement dataset

A complete dataset includes:

- Date/time
- Meter name, series number
- Sensor name, series number
- ID number

- Measured value of the connected sensor
- Measured temperature value of the connected sensor
- AutoRead info: *AR* appears with the measured value if the AutoRead criterion was met while storing (stable measured value). Otherwise, the *AR* display is missing.
- Calibration evaluation:
 - 4 levels (+++, ++, +, -, or no evaluation) or
 - QSC (percentage)

11.3.4 Storage locations

The MultiLab 4010-3 meter has two measurement data storages. The measured values recorded either manually or automatic are stored separately in individual measurement data storages.

Storage	Maximum number of datasets
<i>Manual data storage</i>	500
<i>Automatic data storage</i>	10000

12 Transmitting data

12.1 Outputting current measurement data

1. Output the current measurement data to an interface with **<PRT>**.
 - USB-B: e.g.: PC
 - USB-A: e.g.: printer or USB flash drive (if no PC is connected)

12.2 Transmitting data

The meter has the following interfaces:

- USB-B interface (*USB Device*)
e.g. to connect a PC
- USB-A interface (*USB Host*),
e.g. to connect a USB flash drive/USB printer

Via the USB-B interface (*USB Device*) you can transmit data to a PC or printer and update the meter software.

Via the USB-A interface (*USB Host*) it is possible to transfer data to an external USB memory device/USB printer.

12.3 Connecting the PC / USB-B interface (*USB Device*)

Connect the MultiLab 4010-3 to the PC via the USB-B interface.

System requirements of the PC for installation of the USB driver:

- PC with at least one free USB connection and CD-ROM drive
- Windows 2000, Windows XP, Windows Vista or Windows 7.

1. Insert the supplied installation CD in the CD drive of your PC.
2. Install the driver from the CD.
Follow the Windows installation instructions as necessary.
3. Connect the MultiLab 4010-3 to the PC via the USB-B interface.
The meter is listed as a virtual COM interface among the connections in the Windows instrument manager.

Installation of the USB driver on the PC

4. Set the same transmission data at the connected instrument (PC):
 - Baud rate: to be selected in the range 1200 ... 19200
 - Handshake: RTS/CTS
 - Set at the PC only:
 - Parity: none
 - Data bits: 8
 - Stop bits: 2

12.4 Connecting a USB memory device/USB printer (USB-A interface (*USB Host*))

Connect the USB-A interface (*USB Host*) of the MultiLab 4010-3 to a USB flash drive/USB printer.

1. Connect a USB memory device/USB printer to the *USB Host* interface.

Suitable USB printers:

Model	Type	Paper width
Citizen CT-S281	Thermal transfer printer	58 mm
Star SP700 with USB interface*	Matrix printer	76 mm

- * Recommended printer settings for Star SP700:
- CodePage 437
 - DIP switch 1...7: =ON, DIP switch 8: OFF
- Details: see operating manual of your printer.

12.5 Options for data transmission to the USB-B (PC) interface and the USB-A (USB printer) interface

Via the USB-B interface you can transmit data to a PC.

Via the USB-A interface, you can transmit data to a USB printer or USB memory device. How to transmit data to a USB memory device is described in an extra section (see section 12.6 DATA TRANSMISSION TO THE USB-A INTERFACE (USB MEMORY DEVICE), page 111).

The following table shows which data are transmitted to the interface in which way:

Data	Control	Operation / description
Current measured values of all connected sensors	Manual	<ul style="list-style-type: none"> ● With <PRT>. ● Simultaneously with every manual data storage process (see section 11.1 MANUAL DATA STORAGE, page 102).
	Automatic, at intervals	<ul style="list-style-type: none"> ● With <PRT_>. Then you can set the transmission interval. ● Simultaneously with every automatic data storage process (see section 11.2 AUTOMATIC DATA STORAGE AT INTERVALS, page 102).
Stored measured values	Manual	<ul style="list-style-type: none"> ● Displayed dataset with <PRT> after calling up from the storage. ● All datasets with the <i>Output to RS232/USB</i> function. (see section 11.3.1 EDITING THE MEASUREMENT DATA STORAGE, page 105). ● All datasets with the <i>Output to USB flash drive or printer</i> function (USB-A interface) <p>For details, see section 11.3.1 EDITING THE MEASUREMENT DATA STORAGE, page 105.</p>
Calibration records	Manual	<ul style="list-style-type: none"> ● Displayed calibration record with <PRT> (see section 5.2.6 CALIBRATION DATA, page 36; section 8.2.6 CALIBRATION DATA, page 75; section 9.3.4 CALIBRATION DATA, page 82). ● All calibration records with the <i>Output to USB flash drive or printer</i> function. ● All calibration records with <PRT_>. <p>For details, see section 12 TRANSMITTING DATA, page 108.</p>
	Automatic	<ul style="list-style-type: none"> ● At the end of a calibration procedure.



The following rule applies: With the exception of the menus, shortly pressing the **<PRT>** key generally outputs the display contents to the interface (displayed measured values, measurement datasets, calibration records).

12.6 Data transmission to the USB-A interface (USB memory device)

Via the USB-A interface, you can transmit data to a USB memory or USB printer device. How to transmit data to a USB printer device is described in an extra section (see section 12.6 DATA TRANSMISSION TO THE USB-A INTERFACE (USB MEMORY DEVICE), page 111).

The following table shows which data are transmitted to the interface in which way:

Data	Control	Operation / description
Stored measured values	Manual	All datasets with the <i>Output to RS232/USB</i> function. For details, see section 11.3.1 EDITING THE MEASUREMENT DATA STORAGE, page 105
Calibration data storage	Manual	All stored calibration records of a sensor with the <i>Calibr. data storage to USB flash drive</i> function. For details, see menu for calibration and measurement settings of the sensor.

12.7 MultiLab Importer

With the aid of the MultiLab Importer software, you can record and evaluate measurement data with a PC.



More detailed information can be found in the MultiLab Importer operating manual.

12.8 BOD Analyst Pro

With the aid of the BOD Analyst Pro software you can administrate BOD measurement on the PC and automatically calculate the measured values.



More detailed information can be found in the BOD Analyst Pro operating manual.

13 Maintenance, cleaning, disposal

13.1 Maintenance

13.1.1 General maintenance activities

The only maintenance activity required is exchanging the battery that buffers the system clock.



See the relevant operating manuals of the IDS sensors for instructions on maintenance.

13.1.2 Exchanging the battery

The MultiLab 4010-3 has a battery (CR2032 type) to buffer the system clock in case of a power failure.



To retain the current setting of the date and time during the battery exchange, supply the meter with power with the power pack while changing the battery.

To avoid that the system clock is reset in the case of a power failure, we recommend changing the battery before the end of its service life (the battery included in the scope of delivery after approx. 8 years).

1. Unscrew the screws (2) of the lid of the battery compartment with a screwdriver.

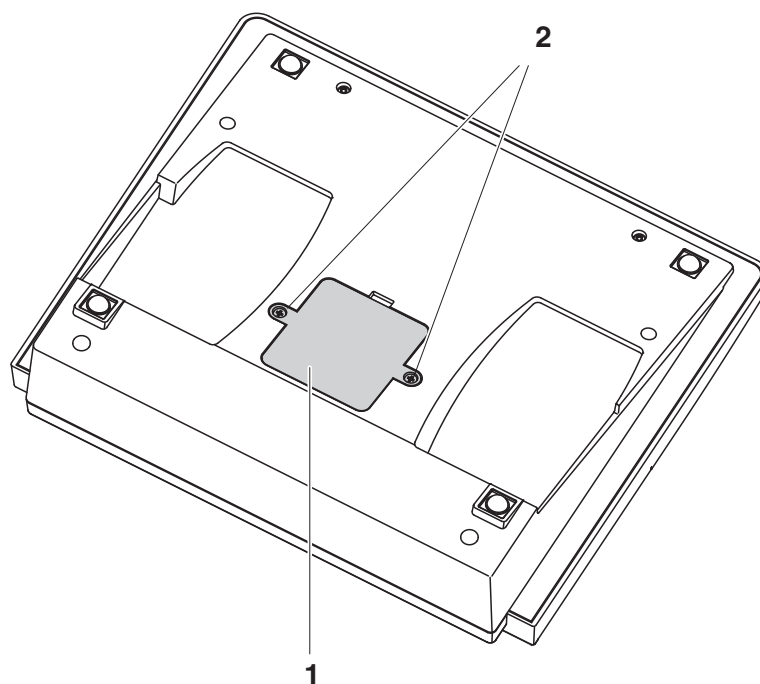

2. Open the battery compartment (1) on the underside of the meter.
3. Remove the battery from the battery compartment.
4. Insert a new battery in the battery compartment.
5. Close the battery compartment (1).
The date (day) flashes on the display.
6. Tighten the screws (2) of the lid of the battery compartment with a screwdriver.
7. Set the date and time (see 4.5.5 EXAMPLE 2 ON NAVIGATION: SETTING THE DATE AND TIME, PAGE 25)



Dispose of used batteries according to the local regulations of your country.

End users within the European Union are obligated to return used batteries (even ecologically compatible ones) to a collection point set up for recycling purposes.

Batteries are marked with the crossed-out waste container symbol. Therefore, they may not be disposed with the domestic waste.

13.2 Cleaning

Occasionally wipe the outside of the measuring instrument with a damp, lint-free cloth. Disinfect the housing with isopropanol as required.



CAUTION

The housing is made of synthetic material (ABS). Thus, avoid contact with acetone or similar detergents that contain solvents. Remove any splashes immediately.

13.3 Packing

This meter is sent out in a protective transport packing. We recommend: Keep the packing material. The original packing protects the meter against damage during transport.

13.4 Disposal

At the end of its operational lifetime, the meter must be returned to the disposal or return system statutory in your country. If you have any questions, please contact your supplier.

14 What to do if...

14.1 pH



More information and instructions on cleaning and exchange of sensors are given in the documentation of your sensor.

Error message <i>OFL, UFL</i>	Cause	Remedy
	IDS pH sensor:	
	– Measured value outside the measuring range	– Use suitable IDS pH sensor
	– Air bubble in front of the diaphragm	– Remove air bubble
	– Air in the diaphragm	– Extract air or moisten junction
	– Cable broken	– Exchange IDS pH sensor
	– Gel electrolyte dried out	– Exchange IDS pH sensor

Error message, <i>Error</i>	Cause	Remedy
	IDS pH sensor:	
	– The values determined for zero point and slope of the IDS pH sensor are outside the allowed limits.	– Recalibrate
	– Diaphragm contaminated	– Clean diaphragm
	– IDS pH sensor broken	– Exchange IDS pH sensor
	Buffer solutions:	
	– The used buffer solutions do not agree with the set buffer set	– Set different buffer set or – Use different buffer solutions
	– Buffer solutions too old	– Use only once. Note the shelf life
	– Buffer solutions depleted	– Change solutions

No stable measured value	Cause	Remedy
	IDS pH sensor:	
– Diaphragm contaminated		– Clean diaphragm
– Membrane contaminated		– Clean membrane
Test sample:		
– pH value not stable		– Measure with air excluded if necessary
– Temperature not stable		– Adjust temperature if necessary
IDS pH sensor + test sample:		
– Conductivity too low		– Use suitable IDS pH sensor
– Temperature too high		– Use suitable IDS pH sensor
– Organic liquids		– Use suitable IDS pH sensor
Obviously incorrect measured values	Cause	Remedy
	IDS pH sensor:	
– IDS pH sensor unsuitable		– Use suitable IDS sensor
– Temperature difference between buffer and test sample too great		– Adjust temperature of buffer or sample solutions
– Measurement procedure not suitable		– Follow special procedure

14.2 ISE

Error message <i>OFL</i>	Cause	Remedy
	– Measuring range exceeded	– Dilute the test sample
Obviously incorrect measured values	Cause	Remedy
	– Electrode not connected	– Connect the electrode
	– Cable broken	– Replace the electrode
Error message, Error (invalid calibration)	Cause	Remedy
	<i>ISE electrode:</i>	
	– Moisture in the plug	– Dry the plug
	– Electrode obsolete	– Replace the electrode
	– Electrode not suitable for the range to be measured	– Use a suitable electrode
	– Electrode not suitable for the selected ion	– Use a suitable electrode or select a suitable ion
	– The gas-sensitive electrode NH 500 was calibrated with the NH4 setting	– Select the following settings: <i>Ion type "ION", Valency "-1"</i>
	– Socket damp	– Dry the socket
	<i>Calibration procedure:</i>	
	– Wrong sequence of standards for three point calibration	– Select the correct sequence
– Calibration standards do not have the correct temperature (max. ± 2 °C temperature difference)	– Adjust the temperature of the calibration standards	
Warning [<i>TpErr</i>]	Cause	Remedy
	– Temperature difference between measurement and calibration greater than 2 K.	– Adjust the temperature of the test sample
Warning [<i>ISEErr</i>]	Cause	Remedy
	– Electrode voltage outside calibrated range	– Recalibrate

14.3 Dissolved oxygen



More information and instructions on cleaning and exchange of sensors are given in the documentation of your sensor.

Error message, <i>OFL</i>	Cause	Remedy
	– Measured value outside the measuring range	– Select a suitable measuring medium
Error message, <i>Error</i>	Cause	Remedy
	– Sensor contaminated	– Clean the sensor
	– Measured temperature value outside the operating conditions (display of OFL/UFL instead of a temperature value)	– Keep to the temperature range for the test sample
	– Defective sensor	– Calibrate – Change sensor cap – Replace sensor

14.4 Conductivity



More information and instructions on cleaning and exchange of sensors are given in the documentation of your sensor.

Error message, <i>OFL</i>	Cause	Remedy
	– Measured value outside the measuring range	– Use suitable IDS conductivity sensor
Error message, <i>Error</i>	Cause	Remedy
	– Sensor contaminated	– Clean the sensor and replace it if necessary
	– Calibration solution not suitable	– Check the calibration solutions

14.5 General information

Sensor symbol flashes	Cause <ul style="list-style-type: none"> – Calibration interval expired 	Remedy <ul style="list-style-type: none"> – Recalibrate the measuring system
Meter does not react to keystroke	Cause <ul style="list-style-type: none"> – Operating condition undefined or EMC load unallowed 	Remedy <ul style="list-style-type: none"> – Processor reset: Press the <ENTER> and <On/Off> key simultaneously
You want to know which software version is in the meter or IDS sensor	Cause <ul style="list-style-type: none"> – E. g., a question by the service department 	Remedy <ul style="list-style-type: none"> – Switch on the meter. – Open the menu, <ENTER_> / <i>Storage & config / System / Service information</i>. The instrument data are displayed. <p>or</p> <ul style="list-style-type: none"> – Connect the sensor. Press softkey <i>[Info]/[More]</i> The sensor data are displayed (see section 4.1.6 SENSOR INFO, page 17)
Data transmission to USB memory device does not work	Cause <ul style="list-style-type: none"> – Connected USB memory device was not recognized – The USB-B interface is connected to a PC – The USB memory device has been formatted to a file system which is not supported, e. g. NTFS 	Remedy <ul style="list-style-type: none"> – Use other USB memory device – Disconnect the PC from the USB-B interface – Reformat the USB memory device to FAT 16 or FAT 32 file system (Caution: Reformatting erases all data on the USB memory device. Back up all data before reformatting.)

Data transmission to USB printer does not work	Cause	Remedy
	<ul style="list-style-type: none"> – The USB-B interface is connected to a PC – Connected USB memory device does not work 	<ul style="list-style-type: none"> – Disconnect the PC from the USB-B interface – Use a suitable USB printer (see section 12.4 CONNECTING A USB MEMORY DEVICE/USB PRINTER (USB-A INTERFACE (USB HOST)), page 109) – Check printer settings (see section 12.4 CONNECTING A USB MEMORY DEVICE/USB PRINTER (USB-A INTERFACE (USB HOST)), page 109)
Error message, <i>Memory error 1</i>	Cause	Remedy
	<ul style="list-style-type: none"> – Instrument storage was not found 	<ul style="list-style-type: none"> – <i>Please contact the service.</i>
Time gets lost	Cause	Remedy
	<ul style="list-style-type: none"> – Buffer battery is empty 	<ul style="list-style-type: none"> – Change the buffer battery (see section 13.1.1 GENERAL MAINTENANCE ACTIVITIES, page 112)

15 Technical data

15.1 Measuring ranges, resolution, accuracy

Measuring ranges,
accuracy

Parameter	Measuring range	Accuracy
Air pressure (absolute)*	225 ... 825 mm Hg	± 3 mm Hg

*Available only if a D.O. sensor is connected



Further data are given in the documentation of your sensor.

15.2 General data

Dimensions	Approx. 180 x 80 x 55 mm (11.22 x 10.04 x 3.15 inches)	
Weight	Approx. 0.4 kg	
Mechanical structure	Type of protection	IP 43
Electrical safety	Protective class	III
Test certificates	CE, cETLus	
Ambient conditions	Storage	- 25 °C ... + 65 °C
	Operation	0 °C ... + 40 °C
	Admissible relative humidity	Yearly mean: < 75 % 30 days/year: 95 % Other days: 85 %
Power supply	Power pack	Kuantech Co. Ltd. KSAC 0900110W1UV-1 Input: 100 ... 240 V ~ / 50 ... 60 Hz / 270 mA Output: 9 V = / 1.1 A Connection max. overvoltage category II Primary plugs contained in the scope of delivery: Euro, US, UK and Australian.
	Battery (to buffer the system clock in the case of a power failure)	3.0 V lithium manganese dioxide battery, type CR 2032
USB interface (device)	Type	USB 1.1 USB-B (Device), PC
	Baud rate	Adjustable: 1200, 2400, 4800, 9600, 19200 Baud
	Data bits	8
	Stop bits	2

	Parity	None
	Handshake	RTS/CTS
	Cable length	Max. 3 m
USB interface (host)	Type	USB 2.0 USB-A (host), USB device
Guidelines and norms used	EMC	EC directive 2004/108/EC EN 61326-1 EN 61000-3-2 EN 61000-3-3 FCC Class A
	Meter safety	EC directive 2006/95/EC EN 61010-1 UL 61010-1 CAN/CSA-C22.2#61010-1
	IP protection class	EN 60529

FCC Class A Equipment Statement

Note: This equipment has been tested and found to comply with the limits for a Class A digital device, pursuant to Part 15 of the FCC Rules. These limits are designed to provide reasonable protection against harmful interference when the equipment is operated in a commercial environment. This equipment generates, uses, and can radiate radio frequency energy and, if not installed and used in accordance with the instruction manual, may cause harmful interference to radio communications. Operation of this equipment in a residential area is likely to cause harmful interference in which case the user will be required to correct the interference at his own expense. Changes or modifications not expressly approved by the manufacturer could void the user's authority to operate the equipment.

Keypad (antibacterial)

Client: **Autotype International Limited****Grove Road
Wantage
Oxon
OX12 7B2
United Kingdom***Job Ref:* **04I0712***Sample Ref No.:* **LSN 25/71815***Date Received:* **15/07/2004***Date Reported:* **03/03/2005****CERTIFICATE OF ANALYSIS**AUTOTEXAM*Meth. Desc***FILM TEST***Supplier:***AUTOTYPE**

Test	Result	Unit	Est
Salmonella enteritidis	99.6	%	Reduction After 24 Hours
Klebsiella pneumoniae	99.4	%	Reduction After 24 Hours
Pseudomonas aeruginosa	99.1	%	Reduction After 24 Hours
Streptococcus faecalis	99.4	%	Reduction After 24 Hours
Phoma violacea	99.0	%	Reduction After 48 Hours
Penicillium purpurogenum	99.3	%	Reduction After 48 Hours
Bacillus cereus	99.3	%	Reduction After 24 Hours
Sacharmyces cerevisiae	99.3	%	Reduction After 24 Hours

Comment: **The microbiological results demonstrate that the material under test exhibits biocidal activity.****R.P.Elliott**
CChem, MRSC, MIFST
*Deputy Managing
Director***C.Fuller**
BSc. (Hons.), CBiol., MBiol.,
MIFST
*Company Microbiologist***J.Lloyd**
BSc. (Hons.)
*Principal
Microbiologist***P.M.Sutton**
CChem., MRSC.
*Nutritional Services
Manager***J.Elliott**
BSc. (Hons.), CBiol., MBiol
*Senior
Microbiologist***J. Francis**
BSc. (Hons.)
*Senior Microbiologist***N.Stanton**
BSc. (Hons.)
*Senior
Microbiologist***Law Laboratories Ltd** Shady Lane, Great Barr, Birmingham B44 9ET England

04I0712/6/1/1

Client: **Autotype International Limited**
Grove Road
Wantage
Oxon
OX12 7B2
United Kingdom

Job Ref: **05B1760**
Sample Ref No.: **LSN 26/38123**
Date Received: **24/10/2004**
Date Reported: **21/02/2005**

CERTIFICATE OF ANALYSIS

AUTOTEX AM AGED 15 YEARS

Meth. Desc **Harmonised JIS Z2801/AATCC 100**

Test	Result	Unit	Est
Staphylococcus aureus	99.0	%	Reduction After 24 Hours
Escherichia coli 0157	99.8	%	Reduction After 24 Hours
Aspergillus niger	99.1	%	Reduction After 48 Hours

Comment: **The microbiological results demonstrate that the material under test exhibits biocidal activity against the above listed microbial strains.**



R.P.Elliott
 CChem, MRSC, MIFST
Deputy Managing Director

C.Fuller
 BSc. (Hons.), CBiol., MBiol., MIFST
Company Microbiologist

J.Lloyd
 BSc. (Hons.)
Principal Microbiologist

P.M.Sutton
 CChem, MRSC.
Nutritional Services Manager

J.Elliott
 BSc. (Hons.), CBiol., MBiol
Senior Microbiologist



J. Francis
 BSc. (Hons.)
Senior Microbiologist

N.Stanton
 BSc. (Hons.)
Senior Microbiologist

Law Laboratories Ltd Shady Lane, Great Barr, Birmingham B44 9ET England

05B1760/1/3/:

16 Firmware update

16.1 Firmware update for the meter MultiLab 4010-3

You can find available firmware update files for your meter on the Internet. With the "Firmware Update " program and a PC you can update the firmware of the MultiLab 4010-3 to the newest version.

For the update you have to connect the meter to a PC.

For the update via the USB-B interface, the following is required:

- a free USB interface (virtual COM port) on the PC
- the driver for the USB interface (on the enclosed CD-ROM)
- the USB cable (included in the scope of delivery of the MultiLab 4010-3).

1. Install the downloaded firmware update on a PC.
An update folder is created in the Windows start menu.
If an update folder already exists for the meter (or meter type), the new data are displayed there.
2. In the windows start menu, open the update folder and start the firmware update program for the meter
3. Using the USB interface cable, connect the MultiLab 4010-3 to a USB interface (virtual COM port) of the PC.
4. Switch on the MultiLab 4010-3.
5. In the firmware update program, start the update process with OK.
6. Follow the instructions of the firmware update program.
During the programming process, a corresponding message and a progress bar (in %) are displayed.
The programming process takes up to 15 minutes. A terminatory message is displayed after a successful programming process. The firmware update is completed.
7. Disconnect the MultiLab 4010-3 from the PC.
The MultiLab 4010-3 is ready for operation again.

After switching the meter off and on you can check whether the meter has taken over the new software version (see YOU WANT TO KNOW WHICH SOFTWARE VERSION IS IN THE METER OR IDS SENSOR, PAGE 119).

16.2 Firmware-Update for IDS Sensors

With the "Firmware Update" program and a PC you can update the firmware of an IDS sensor to the newest version.

You can find available firmware update files for your IDS sensor on the Internet.

For updating, connect the IDS sensor to the MultiLab 4010-3, and the MultiLab 4010-3 to a PC.

For the update via the USB-B interface, the following is required:

- a free USB interface (virtual COM port) on the PC
- the driver for the USB interface (on the enclosed CD-ROM)
- the USB cable (included in the scope of delivery of the MultiLab 4010-3).

1. Install the downloaded firmware update on a PC.
An update folder is created in the Windows start menu.
If an update folder already exists for the sensor (or sensor type), the new data are displayed there.
2. In the windows start menu, open the update folder and start the firmware update program for the IDS sensor
3. Connect the IDS sensor to the MultiLab 4010-3 meter.
4. Using the USB interface cable, connect the MultiLab 4010-3 to a USB interface (virtual COM port) of the PC.
5. Switch on the MultiLab 4010-3.
6. In the firmware update program, start the update process with OK.
7. Follow the instructions of the firmware update program.
During the programming process, a corresponding message and a progress bar (in %) are displayed.
The programming process takes up to 5 minutes. A terminatory message is displayed after a successful programming process. The firmware update is completed.
8. Disconnect the MultiLab 4010-3 from the PC.
Meter and sensor are ready for operation again.

After switching the meter off and on you can check whether the sensor has taken over the new software version (see YOU WANT TO KNOW WHICH SOFTWARE VERSION IS IN THE METER OR IDS SENSOR, PAGE 119).

17 Glossary

pH/ORP/ISE

Asymmetry	see zero point
Electromotive force of a combination electrode	The electromotive force U of the combination electrode is the measurable electromotive force of an electrode in a solution. It equals the sum of all the galvanic voltages of the combination electrode. Its dependency on the pH results in the electrode function, which is characterized by the parameters, slope and zero point.
Junction	The junction is a porous body in the housing wall of reference electrodes or electrolyte bridges. It arranges the electrical contact between two solutions and makes the electrolyte exchange more difficult. The expression, junction, is also used for ground or junction-less transitions.
ORP voltage (U)	The ORP is caused by oxidizing or reducing substances dissolved in water if these substances become effective on an electrode surface (e. g. a gold or platinum surface).
pH value	The pH value is a measure of the acidic or basic effect of an aqueous solution. It corresponds to the negative decadic logarithm of the molal hydrogen ions activity divided by the unit of the molality. The practical pH value is the value of a pH measurement.
Potentiometry	Name of a measuring technique. The signal (depending on the measured parameter) of the electrode is the electrical potential. The electrical current remains constant.
Slope	The slope of a linear calibration function.
Zero point	The zero point of a pH combination electrode is the pH value at which the electromotive force of the pH combination electrode at a specified temperature is zero. Normally, this is at 25 °C.

Conductivity

Cell constant (C)	Characteristic quantity of a conductivity measuring cell, depending on the geometry.
Conductivity (κ)	Short form of the expression, specific electrical conductivity. It corresponds to the reciprocal value of the resistivity. It is a measured value of the ability of a substance to conduct an electric current. In water analysis, the electrical conductivity is a dimension for the ionized substances in a solution.
Reference temperature	Fixed temperature value to compare temperature-dependent measured values. For conductivity measurements, the measured value is converted to a conductivity value at a reference temperature of 20 °C or 25 °C.
Resistance (p)	Short name for the electrolytic resistivity. It corresponds to the reciprocal value of the electrical conductivity.

Salinity	The absolute salinity S_A of seawater corresponds to the relationship of the mass of dissolved salts to the mass of the solution (in g/Kg). In practice, this dimension cannot be measured directly. Therefore, the practical salinity according to IOT is used for oceanographic monitoring. It is determined by measuring the electrical conductivity.
Salt content	General designation for the quantity of salt dissolved in water.
Temperature coefficient	Value of the slope α of a linear temperature function. $\mathcal{R}_{T_{\text{Ref}}} = \mathcal{R}_{\text{Meas}} * \frac{1}{1 + \alpha * (T - T_{\text{Ref}})}$
Temperature compensation	Name of a function that considers the temperature influence on the measurement and converts it accordingly. Depending on the measured parameter to be determined, the temperature compensation functions in different ways. For conductimetric measurements, the measured value is converted to a defined reference temperature. For potentiometric measurements, the slope value is adjusted to the temperature of the test sample but the measured value is not converted.

Dissolved oxygen

D.O. % saturation	Short name for the relative D.O. saturation.
Salinity	The absolute salinity S_A of seawater corresponds to the relationship of the mass of dissolved salts to the mass of the solution (in g/Kg). In practice, this dimension cannot be measured directly. Therefore, the practical salinity according to IOT is used for oceanographic monitoring. It is determined by measuring the electrical conductivity.
Salt content	General designation for the quantity of salt dissolved in water.

General information

Adjusting	To manipulate a measuring system so that the relevant value (e. g. the displayed value) differs as little as possible from the correct value or a value that is regarded as correct, or that the difference remains within the tolerance.
AutoRange	Name of the automatic selection of the measuring range.
Calibration	Comparing the value from a measuring system (e. g. the displayed value) to the correct value or a value that is regarded as correct. Often, this expression is also used when the measuring system is adjusted at the same time (see adjusting).
Measured parameter	The measured parameter is the physical dimension determined by measuring, e. g. pH, conductivity or D.O. concentration.
Measured value	The measured value is the special value of a measured parameter to be determined. It is given as a combination of the numerical value and unit (e. g. 3 m; 0.5 s; 5.2 A; 373.15 K).

Molality	Molality is the quantity (in Mol) of a dissolved substance in 1000 g solvent.
Reset	Restoring the original condition of all settings of a measuring system.
Resolution	Smallest difference between two measured values that can be displayed by a meter.
Stability control (AutoRead)	Function to control the measured value stability.
Standard solution	The standard solution is a solution where the measured value is known by definition. It is used to calibrate a measuring system.
Temperature function	Name of a mathematical function expressing the temperature behavior of a test sample, a sensor or part of a sensor.
Test sample	Designation of the test sample ready to be measured. Normally, a test sample is made by processing the original sample. The test sample and original sample are identical if the test sample was not processed.

18 Index

A

Air calibration beaker	71
AutoRead	70, 78
ORP	43, 45
pH	27, 48

B

Battery compartment	113
Blank value addition	66

C

Calibration	
Conductivity	81
ISE	50
pH	29, 46
Calibration evaluation	
Conductivity	83
ISE	54
O2	76
pH	37
Calibration interval	
Conductivity	93
pH	88
Calibration points	
pH	35
Calibration records	82
Cell constant	81
Comparison measurement (D.O.)	71
Connect the power pack	13
Connecting a PC	108, 109

D

Dataset	106
Date and time	25
Default settings	
Measured parameter	98
System settings	101
Display	15

F

Firmware update	126
-----------------------	-----

I

Initial commissioning	12
Initialize	98
Instrument connectors	16
Interval for calibration	88

K

Keys	14
------------	----

M

Measured value display	21
Measurement accuracy	88
Measurement data storage	
Edit	105
Erase	105
Storage locations	107
Measurement dataset	106
Measuring	
Conductivity	78
ISE	47
O2	69
ORP	43, 44
pH	27
Measuring method	56
Blank value addition	66
Sample addition	62
Sample subtraction	64
Standard addition	57
Standard subtraction	59
Menu for calibration and measurement settings	
pH/ORP	89
Menus (navigation)	21
Messages	23

P

pH buffer sets	86
----------------------	----

R

Reset	98
RS232 interface	109

S

Safety	10
Sample addition	62
Sample subtraction	64
Scope of delivery	12
Single-point calibration	
pH	30, 34
Slope	
ISE	50
pH	29
Stability control	
Automatic	97
Manual	27, 43, 70
Standard addition	57

Standard addition with blank	
value correction	66
Standard subtraction	59
Storage interval	102
Storing in memory	102
Automatic	102
Manual	102

T

Temperature compensation	80
Temperature measurement	
Conductivity	80
ISE	49
O2	71
pH	28, 46
Three-point calibration	
ISE	52
pH	31, 35
Transmitting data	108
Automatic	110
Manual	110
Transmitting measured values	108
Two-point calibration	
ISE	51
pH	30, 34

Z

Zero point of pH electrode	29
----------------------------	----

19 Appendix

19.1 Oxygen solubility table

Solubility of oxygen in mg/L in water exposed to water-saturated air at 760 mm Hg pressure.

Salinity = Measure of quantity of dissolved salts in water.

Chlorinity = Measure of chloride content, by mass, of water.

$S(0/00) = 1.80655 \times \text{Chlorinity } (0/00)$

Temp °C	Chlorinity: 0 Salinity: 0	5.0 ppt 9.0 ppt	10.0 ppt 18.1 ppt	15.0 ppt 27.1 ppt	20.0 ppt 36.1 ppt	25.0 ppt 45.2 ppt
0.0	14.621	13.728	12.888	12.097	11.355	10.657
1.0	14.216	13.356	12.545	11.783	11.066	10.392
2.0	13.829	13.000	12.218	11.483	10.790	10.139
3.0	13.460	12.660	11.906	11.195	10.526	9.897
4.0	13.107	12.335	11.607	10.920	10.273	9.664
5.0	12.770	12.024	11.320	10.656	10.031	9.441
6.0	12.447	11.727	11.046	10.404	9.799	9.228
7.0	12.139	11.442	10.783	10.162	9.576	9.023
8.0	11.843	11.169	10.531	9.930	9.362	8.826
9.0	11.559	10.907	10.290	9.707	9.156	8.636
10.0	11.288	10.656	10.058	9.493	8.959	8.454
11.0	10.027	10.415	9.835	9.287	8.769	8.279
12.0	10.777	10.183	9.621	9.089	8.586	8.111
13.0	10.537	9.961	9.416	8.899	8.411	7.949
14.0	10.306	9.747	9.218	8.716	8.242	7.792
15.0	10.084	9.541	9.027	8.540	8.079	7.642
16.0	9.870	9.344	8.844	8.370	7.922	7.496
17.0	9.665	9.153	8.667	8.207	7.770	7.356
18.0	9.467	8.969	8.497	8.049	7.624	7.221
19.0	9.276	8.792	8.333	7.896	7.483	7.090
20.0	9.092	8.621	8.174	7.749	7.346	6.964
21.0	8.915	8.456	8.021	7.607	7.214	6.842
22.0	8.743	8.297	7.873	7.470	7.087	6.723
23.0	8.578	8.143	7.730	7.337	6.963	6.609
24.0	8.418	7.994	7.591	7.208	6.844	6.498
25.0	8.263	7.850	7.457	7.093	6.728	6.390
26.0	8.113	7.711	7.327	6.962	6.615	6.285
27.0	7.968	7.575	7.201	6.845	6.506	6.184
28.0	7.827	7.444	7.079	6.731	6.400	6.085
29.0	7.691	7.317	6.961	6.621	6.297	5.990
30.0	7.559	7.194	6.845	6.513	6.197	5.896
31.0	7.430	7.073	6.733	6.409	6.100	5.806
32.0	7.305	6.957	6.624	6.307	6.005	5.717

Temp °C	Chlorinity: 0 Salinity: 0	5.0 ppt 9.0 ppt	10.0 ppt 18.1 ppt	15.0 ppt 27.1 ppt	20.0 ppt 36.1 ppt	25.0 ppt 45.2 ppt
33.0	7.183	6.843	6.518	6.208	5.912	5.631
34.0	7.065	6.732	6.415	6.111	5.822	5.546
35.0	6.950	6.624	6.314	6.017	5.734	5.464
36.0	6.837	6.519	6.215	5.925	5.648	5.384
37.0	6.727	6.416	6.119	5.835	5.564	5.305
38.0	6.620	6.316	6.025	5.747	5.481	5.228
39.0	6.515	6.217	5.932	5.660	5.400	5.152
40.0	6.412	6.121	5.842	5.576	5.321	5.078
41.0	6.312	6.026	5.753	5.493	5.243	5.005
42.0	6.213	5.934	5.667	5.411	5.167	4.993
43.0	6.116	5.843	5.581	5.331	5.091	4.861
44.0	6.021	5.753	5.497	5.252	5.017	4.793
45.0	5.927	5.665	5.414	5.174	4.944	4.724
46.0	5.835	5.578	5.333	5.097	4.872	4.656
47.0	5.744	5.493	5.252	5.021	4.801	4.589
48.0	5.654	5.408	5.172	4.947	4.730	4.523
49.0	5.565	5.324	5.094	4.872	4.660	4.457
50.0	5.477	5.242	5.016	4.799	4.591	4.392

19.2 DO% Calibration values

Pressure				Altitude		Calibration value
Inches Hg	mm Hg	kPa	mbar	Feet	Meters	% Saturation
30.22	767.6	102.3	1023	-276	-84	101
29.92	760	101.3	1013	0	0	100
29.62	752.4	100.3	1003	278	85	99
29.32	744.8	99.3	993	558	170	98
29.02	737.2	98.3	983	841	256	97
28.72	729.6	97.3	973	1126	343	96
28.43	722	96.3	963	1413	431	95
28.13	714.4	95.2	952	1703	519	94
27.83	706.8	94.2	942	1995	608	93
27.53	699.2	93.2	932	2290	698	92
27.23	691.6	92.2	922	2587	789	91
26.93	684	91.2	912	2887	880	90
26.63	676.4	90.2	902	3190	972	89
26.33	668.8	89.2	892	3496	1066	88
26.03	661.2	88.1	881	3804	1106	87
25.73	653.6	87.2	871	4115	1254	86
25.43	646	86.1	861	4430	1350	85
25.13	638.4	85.1	851	4747	1447	84
24.84	630.8	84.1	841	5067	1544	83
24.54	623.2	83.1	831	5391	1643	82
24.24	615.6	82.1	821	5717	1743	81
23.94	608.0	81.06	811	6047	1843	80
23.64	600.4	80.05	800	6381	1945	79
23.34	592.8	79.03	790	6717	2047	78
23.04	585.2	78.02	780	7058	2151	77
22.74	577.6	77.01	770	7401	2256	76
22.44	570.0	75.99	760	7749	2362	75
22.14	562.4	74.98	749	8100	2469	74
21.84	554.8	73.97	739	8455	2577	73
21.54	547.2	72.95	729	8815	2687	72
21.26	539.6	71.94	720	9178	2797	71
20.94	532	70.93	709	9545	2909	70
20.64	524	69.92	699	9917	3023	69
20.35	517	68.91	689	10293	3137	68
20.05	509	67.9	679	10673	3371	67
19.75	502	66.89	669	11058	3371	66

20 Contact Information

20.1 Ordering & Technical Support

Telephone: (800) 897-4151
(937) 767-7241
Monday through Friday, 8:00 AM to 5:00 PM ET

Fax: (937) 767-1058

Email: environmental@ysi.com

Mail: YSI Incorporated
1725 Brannum Lane
Yellow Springs, OH 45387
USA

Internet: www.ysi.com

When placing an order please have the following information available:

YSI account number (if available)	Name and Phone Number
Model number or brief description	Billing and shipping address
Quantity	Purchase Order or Credit Card

20.2 Service Information

YSI has authorized service centers throughout the United States and Internationally. For the nearest service center information, please visit www.ysi.com and click 'Support' or contact YSI Technical Support directly at 800-897-4151.

When returning a product for service, include the Product Return form with cleaning certification. The form must be completely filled out for an YSI Service Center to accept the instrument for service. The Product Return form may be downloaded at www.ysi.com and clicking on the 'Support' tab.

Xylem |'zīləm|

- 1) The tissue in plants that brings water upward from the roots;
- 2) a leading global water technology company.

We're 12,500 people unified in a common purpose: creating innovative solutions to meet our world's water needs. Developing new technologies that will improve the way water is used, conserved, and re-used in the future is central to our work. We move, treat, analyze, and return water to the environment, and we help people use water efficiently, in their homes, buildings, factories and farms. In more than 150 countries, we have strong, long-standing relationships with customers who know us for our powerful combination of leading product brands and applications expertise, backed by a legacy of innovation.

For more information on how Xylem can help you, go to www.xylem.com



a **xylem** brand

YSI
1725 Brannum Lane
Yellow Springs, OH 45387
Tel: +1 937-767-7241; 800-765-4974
Fax: +1 937-767-1058
Email: environmental@ysi.com
Web: www.ysi.com

©Xylem Inc